

ORDINANCE NO. 24 - _____

AN ORDINANCE OF PINELLAS COUNTY, FLORIDA REGARDING STORMWATER MANAGEMENT STANDARDS, CRITERIA AND REGULATIONS; PROVIDING FOR ADOPTION OF A REVISED PINELLAS COUNTY STORMWATER MANUAL UPDATING PARTS “A”, “B” AND “C” OF THE MANUAL FOR UNINCORPORATED AREAS; AMENDING SECTION 154-52 OF THE PINELLAS COUNTY LAND DEVELOPMENT CODE TO PROVIDE FOR UPDATED DATES OF REFERENCE; PROVIDING FOR SEVERABILITY; PROVIDING FOR CODIFICATION; AND PROVIDING FOR AN EFFECTIVE DATE.

WHEREAS, effective stormwater management improves surface water quality, prevents flooding, and furthers regulatory goals; and

WHEREAS, to that end, the Pinellas County Board of County Commissioners adopted the Pinellas County Stormwater Manual, effective April 1, 2017 and subsequently adopted a revision effective November 1, 2021, which prescribes stormwater management standards for unincorporated areas and incorporated areas under County control; and

WHEREAS, since the revised November 1, 2021 adoption, the Stormwater Manual regulations have been repeatedly described as too restrictive and inflexible by private sector stakeholders; and

WHEREAS, stakeholder feedback has focused on greater flexibility and relief to smaller scale land development projects; and

WHEREAS, to that end, a peer review of the Stormwater Manual was performed by Vanasse Hangen Brustlin, Inc. (VHB) dated July 2023 which provided for a suite of recommended updates to the manual. Based on the recommendations, Pinellas County Staff proposes revising the Pinellas County Stormwater Manual to, among other things, provide for a small site exemption; modify standards for single family residences on large sites; expand and increase thresholds for administrative adjustments; modify standards for exfiltration systems and trench design; and methodology for stormwater runoff calculations; and

WHEREAS, the proposed revisions are consistent with State law; and

WHEREAS, the Pinellas County Local Planning Agency supports the proposed revisions; and

WHEREAS, the Pinellas County Board of County Commissioners desires to adopt the proposed revisions.

NOW THEREFORE, BE IT ORDAINED by the Board of County Commissioners of Pinellas County, Florida that:

SECTION 1. The recitals above are incorporated herein.

SECTION 2. The Pinellas County Stormwater Manual (Effective April 23, 2024) attached hereto as Exhibit A is hereby adopted.

SECTION 3. Section 154-52 of the Pinellas County Land Development Code is hereby amended to update the effective date of the Pinellas County Stormwater Manual as follows:

The Pinellas County Stormwater Manual is intended to provide detailed drainage requirements and guidelines for the construction of physical improvements. The Pinellas County Stormwater Manual is adopted by ordinance of the county commission and must be amended in the same manner. The Pinellas County Stormwater Manual is kept on file in the development review services and public works departments.

The current version (latest edition) of the Pinellas County Stormwater Manual became effective on April 23, 2024. In the event of any conflict between any language in this version of the Pinellas County Stormwater Manual, and any language in the Pinellas County Land Development Code existing on April 23, 2024, the language in the Pinellas County Stormwater Manual shall prevail.

Notwithstanding section 154-4 (Areas Embraced) of this chapter, the Pinellas County Stormwater Manual shall, as stated therein, apply:

- (a) In all watersheds within unincorporated areas;
- (b) In all properties, easements, rights-of-way, and other areas that the county has jurisdiction over outside of unincorporated areas; and
- (c) To any activity which would effect watersheds within the areas described in subsections (a) and (b) immediately above.

Where the Pinellas County Stormwater Manual applies to an activity that a conflicting municipal regulation also applies to, the more stringent regulation shall apply.

SECTION 4. Severability. If any section or provision of this Ordinance is for any reason held invalid or unconstitutional by any court of competent jurisdiction, such holding shall not be construed to render the remaining provisions of this Ordinance invalid or unconstitutional.

SECTION 5. Inclusion in Code. It is the intention of the Board of County Commissioners that the provisions of this Ordinance be made a part of the Pinellas County Code and that the sections of this Ordinance may be renumbered or relettered and the word "Ordinance" may be changed to section, article, or other such appropriate word or phrase to accomplish such intentions.

SECTION 6. Filing of Ordinance; Effective Date. Pursuant to Section 125.66(b) of the Florida Statutes, within ten (10) days of adoption of this Ordinance, a certified copy of this Ordinance shall be filed with the Department of State by the Clerk of the Pinellas County Board of County Commissioners. This Ordinance shall take effect on April 23, 2024.

APPROVED AS TO FORM
By: Derrill McAteer
Office of the County Attorney

PCAO 466995

EXHIBIT A

PINELLAS COUNTY STORMWATER MANUAL

REVISED APRIL 23, 2024

EXHIBIT A

PINELLAS COUNTY STORMWATER MANUAL

REVISED APRIL 23, 2024



PINELLAS COUNTY

STORMWATER MANUAL

ADOPTED FEBRUARY 1, 2017

REVISED NOVEMBER 1, 2021

REVISED APRIL 23, 2024



TABLE OF CONTENTS

SUMMARY OF CHANGES effective January 2024	4
<i>EXECUTIVE SUMMARY</i>	5
PART A - REGULATIONS	7
Chapter 1 - County stormwater requirements and criteria.....	8
1.1. Introduction.....	9
1.2. Compatibility with State Environmental Resource Permitting (ERP) Rules	9
1.3. Criteria Flexibility and Alternative Designs	9
1.4. Presumptive Criteria	9
1.5. Performance Standards	10
1.6. County-Owned/Operated Stormwater Systems	24
1.7. Erosion and Sediment Control	24
1.8. Inspection and Recertification of Stormwater Treatment Systems.....	27
1.9. Additional Permitting Requirements to Protect Potable Water Supplies	28
1.10. Hazardous or Toxic Substances.....	28
1.12. Off Site Compensating Treatment and Regional Treatment Facilities.....	28
1.13. Professional Certification Requirements	29
1.14. Easement Requirements.....	29
Chapter 2 – Stormwater Quantity and Flood Control Requirements.....	31
2.1. Stormwater Quantity Introduction	31
2.2. Design criteria.	31
2.3. Portion of Water Quality Treatment Volume that can Count towards Water QuantityStorage Requirements -	34
Chapter 3– Stormwater Quality Permitting Requirements.....	35
3.1. Introduction & Performance Standards.....	35
PART B - BEST MANAGEMENT PRACTICE (BMP) CRITERIA	36
Chapter 4 – Best Management Practice Criteria.....	37
4.0. Catalog of Stormwater Best Management Practices (BMPs).....	37
4.1. Retention Basin Design Criteria.....	45
4.3. Underground Retention Systems Design Criteria.....	59
4.4. Bioswales/Treatment Swales/Green Gutters.....	65
4.5. Vegetated Natural Buffers.....	72

4.6.	Pervious Pavement Systems-----	78
4.7.	Green Roof/Cistern Systems -----	97
4.8.	Wet Detention System-----	104
4.9.	Stormwater Harvesting Systems -----	114
4.10.	Up-Flow Filter Systems -----	122
4.11.	Managed Aquatic Plant Systems (MAPS)-----	128
4.12.	Biofiltration Systems with Biosorption Activated Media (BAM)-----	134
4.13.	Rain Gardens-----	152
4.14.	Rainwater Harvesting-----	158
4.15.	Rainfall Interceptor Trees-----	166
PART C - DESIGN GUIDE -----		174
Chapter 5 – Background Information -----		175
5.1.	Purpose and Intent-----	175
5.2.	Stormwater Introduction -----	175
5.3.	Local Context -----	176
Chapter 6 – Evaluating and Master Planning a Site-----		180
6.1.	Overview -----	180
6.2.	Impacts of Development on Runoff -----	180
6.3.	Goals of Stormwater Management-----	181
6.4.	Introduction to Stormwater Management-----	182
6.5.	Introduction to Green Infrastructure Best Management Practices-----	184
6.6.	Site Planning and Design with Green Infrastructure -----	190
6.7.	Site Planning Principles-----	192
6.8.	Source Control BMPs -----	200
6.9.	Performance Monitoring and Maintenance -----	206
6.10	Design References-----	206
Appendix A – Methodologies -----		224
Appendix B – Rainfall Distribution -----		234
Appendix C – Stormwater Retrofits-----		242
Appendix D – Florida Department of Environmental Protection Management Action Plan ----		243
Appendix E – Pinellas County Receiving Waters and TMDL Status-----		247
Appendix F – Inspection Form-----		248
Appendix G – Definitions and Acronyms -----		250
Appendix H: Example Projects Using Green Infrastructure-----		260
Appendix I: Bioretention Media Supplemental Specification -----		262
Appendix J: List of Plants and Trees for BMPs-----		263
REFERENCES -----		265

SUMMARY OF CHANGES effective January 2024

- Final version as recommended by the Stakeholder group, the Local Planning Agency, and County Staff
- Part A, Chapter 1, Section 1.5.1(1) amended to define small site exemption for reduction in impervious for development and redevelopment.
- Part A, Chapter 1, Section 1.5.1(2) County Stormwater requirements and Criteria, Performance Standards, Exemptions amended to include triplex residents.
- Part A, Chapter 1, Section 1.5.3 (6) Waivers and Adjustments, revised to Part A, Chapter 1, Section 1.5.3 (6) Administrative Adjustments and Variances.
 - 1.5.3.1 Administrative Adjustments clarification of small sites and large site criteria.
 - 1.5.3.2 Variances added to define the adjustments which may be sought.
- Part A, Chapter 1, Section 1.5.5.11 (2) County Stormwater Requirements and Criteria Performance Standards, Stormwater Outfalls amended for clarification.
- Part A, Chapter 1, Section 1.5.5.11 (3) County stormwater Requirements and Criteria, Performance Standards, Stormwater Outfalls amended to include alternative outfall guidance.
- Part A, Regulations – Chapter 2, Stormwater Quantity and Flood Control Requirements, Design Criteria, Section 2.2.5 Calculation of runoff rates amended to clarify the site acreage allowed for use of the Rational method.
- Part A, Chapter 2.3.3 Exfiltration Maintenance and Life Expectancy amended clarify the maintenance requirements and life expectancy of exfiltration systems.
- Part A, Regulations, Chapter 3, Stormwater Quantity Permitting Requirements, Introduction & Performance Standards, Section 3.1.1 General Performance Standards amended to include the reduction in nutrient loading pre and post development.
- Part B, Chapter 4, Section 4.2.4(g), Exfiltration Trench Design Criteria, Design and Performance Criteria amended to clarify the recovery of the required treatment volume of a dry exfiltration trench.
- Part B, Chapter 4, Section 4.2.4(l) Exfiltration Trench Design Criteria, Design and Performance Criteria amended to define the aggregate void space values.
- Part B, Chapter 4, Section 4.3.4(d) Underground Retention Systems Design Criteria, Design and Performance Criteria amended to define the aggregate void space values.
- Part C, Chapter 6, Section 6.10.1 Calculation of Runoff Rates amended for consistency.
- Additions made to definitions.

PINELLAS COUNTY

STORMWATER MANUAL

EXECUTIVE SUMMARY



EXECUTIVE SUMMARY

Pinellas County is an urbanized coastal Florida community with approximately 1 million permanent residents and more than 6 million annual tourists and visitors. This population is attracted by the County's sub-tropical location on a peninsula surrounded by the clean waters of the Gulf of Mexico, Tampa Bay and smaller bays with inland lakes and streams. These areas are also generally designated as aquatic preserves by the State. However, the geographic, demographic, environmental, climatic, and low-topographic characteristics of Pinellas County makes the community, its economy and its infrastructure susceptible to water quality impairment, flooding and threat from powerful tropical windstorms and storm surges as well as the effects of future climatic change and sea level rise. These risks require preemptive measures to preserve and improve water quality and protect the County from flooding.

Pinellas County is almost entirely built-out. Most future development will occur as redevelopment, adaptive reuse, and/or retrofits. In recognizing these facts and conditions, this manual was created to promote an advanced stormwater management approach which incorporates a variety of green infrastructure, or low impact development, options to address stormwater quantity/quality standards as redevelopment occurs with consideration of the conditions now and in the future.

This manual was created by a diverse stakeholder group that included the development community and regulatory agencies to provide a comprehensive and systematic approach to stormwater design. Stormwater management, including water quantity and quality, should be approached in a holistic manner considering the setting, natural hydrology, existing conditions, project type, and community character. Stormwater management needs to be focused and integrated into the project's core design using a variety of methods for addressing stormwater in a redeveloping community.

This manual will be used in conjunction with the Pinellas County Comprehensive Plan and Land Development Code. The standards, herein, have their basis in the State of Florida Environmental Resource Permit (ERP) and the administrative standards established by the Southwest Florida Water Management District (SWFWMD). In addition to compliance with state standards, the County has the added responsibility of operating and maintaining its stormwater management system, to provide flood protection to its citizens, and a responsibility to protect receiving water bodies from pollution and degradation for the enjoyment of all County residents. The County, through its codes and policies, may allow design flexibility while establishing quantity/quality goals to ensure a sustainable future.

This manual is designed in three distinct parts that each address the stages of the stormwater design process:

Part A: Pinellas Stormwater Requirements – This part establishes the overall stormwater standards. This includes performance standards and technical requirements. This part also establishes the stormwater quantity and quality standards that are required for development activity in Pinellas County.

Part B: Best Management Practice (BMP) Criteria – This part establishes the various stormwater methods that are allowed/approved in Pinellas County. This includes specific design criteria, standards, and details for each method. It is intended to allow for several stormwater methods so that there is a comprehensive, yet flexible means to manage stormwater in a redevelopment setting.

Part C: Background Information and Site Planning – This part addresses the purpose and intent of the stormwater management and how it relates to Pinellas County. It also establishes the community's expectation as to how sites are designed, redeveloped, and maintained.



Identifies areas in the manual on quantitative tools to improve nutrient removal



PINELLAS COUNTY
STORMWATER MANUAL
PART A - REGULATIONS



Chapter 1 - County stormwater requirements and criteria

Chapters 1 and 2 provide water quality and water quantity criteria, technical guidance, and design specifications for stormwater management systems and practices. Additional BMP-specific guidance and technical specifications are found in Part B - Best Management Practice Criteria, Chapter 4.

The Stormwater Manual requirements shall apply within the following areas:

1. All watersheds within the unincorporated area of Pinellas County.
2. Property, easements, right of way and/or any other areas which the County has jurisdiction over outside the unincorporated area of the County,
3. Any activity which would have an effect on watersheds within the areas described in 1. and 2. above.

Green Infrastructure

Green Infrastructure (GI) elements could be incorporated in a site design to supplement the attenuation and treatment capabilities of common retention/detention elements – and where possible substitute for such common elements – to achieve compliance with the County’s regulatory requirements for water quantity and quality. The County has developed a list of such GI elements to aid and encourage any developers, consultants, engineers, to use where appropriate. The County has also provided typical CAD design templates associated with these GI elements to further assist in their adoption and implementation. The list of GI elements with templates provided includes:

1. Rain Gardens
2. Bio-Swales
3. Green Gutters
4. Pervious and Flexible Pavement
5. Pervious Pavers
6. Tree Boxes
7. Trench Drains
8. Biologically Activated Media (BAM) and similar soil amendments

Other GI elements to consider include:

1. Active Stormwater Harvesting (Pumping from BMPs)
2. Passive Stormwater Harvesting (Cisterns, Rain Barrels, etc.)
3. Green Roofs

A full explanation and design details for these elements are included in Part B-Catalog of BMPs.

1.1. Introduction

The Pinellas County Comprehensive Plan and the Pinellas County Code provide general and specific requirements associated with the management of stormwater and the protection of the County's natural resources. The Comprehensive Plan includes goals, objectives, and policies associated with minimizing impacts from stormwater. The following elements address the County's adopted goals:

- **Natural Resource Conservation and Management Element**
- **Coastal Management Element**
- **Surface Water Management Element**

The Pinellas County Code includes provisions that regulate stormwater management and design. The following portions establish the County's standards:

- **Part II – Pinellas County Code**
 - [Chapter 58 – Environment - Article VI \(Stormwater and Surface Water Protection\)](#)
- **Part III – Land Development Code**
 - [Chapter 138 – Zoning – Article X \(Community Design Standards\) – Divisions 1 and 3](#)
 - [Chapter 154 – Site Development, Right-of-way Improvements, Subdivisions, and Platting - Article II](#)
 - [Chapter 158 – Floodplain Management](#)

1.2. Compatibility with State Environmental Resource Permitting (ERP) Rules

Development projects in Pinellas County are likely to also require permits under the Statewide [Environmental Resource Permitting Rules \(Chapter 62-330, Florida Administrative Code\)](#). Both State and County requirements for stormwater management share the common goal of ensuring that stormwater discharges do not cause or contribute to violations of state water quality standards. This manual is written with the intent of being compatible with State rules. Applicants should be cautioned; however, that the thresholds, criteria, and design standards in this manual are not necessarily identical to those in State rules.

1.3. Criteria Flexibility and Alternative Designs

An applicant may propose alternative designs to the stormwater quality and quantity design criteria provided in this Manual. Alternative designs will be considered by the County in determining whether, based on plans, storm and load monitoring data, test results, or other information, that the alternative design is suitable for the specific site conditions, and provides equivalent water quality and quantity treatment to that required by the performance standards in this Manual. In otherwise determining whether reasonable assurance has been provided for compliance with this paragraph, the County will consider:

- (a) Whether the proposed system will provide the level of attenuation, storage and treatment required by the performance standards in this Manual; and
- (b) Whether reasonable provisions have been made to ensure that the system will be effectively operated and maintained.

1.4. Presumptive Criteria

Requirements established in this manual for stormwater management systems are based on performance standards and design criteria which are presumed to enable those systems to meet County goals and objectives provided herein. For the purposes of this manual, BMP effectiveness is based on removal of nutrients (i.e., total nitrogen and total phosphorus). It is presumed that systems designed to achieve

adequate treatment efficiencies for nutrients will be sufficient to adequately treat other pollutants that could otherwise cause or contribute to water quality violations. A presumptive approach generally allows applicants to provide reasonable assurance that systems will comply with County codes without requiring monitoring or substantial amounts of site-specific information. The presumption is rebuttable however, by either the applicant or the County, if site-specific information exists which indicates County goals and objectives will not be met unless additional or alternative measures are taken. More information about the pollutant load effectiveness of BMPs is included in the BMP descriptions in Chapter 6 and in Appendix D of this manual.

1.5. Performance Standards

Unless specifically exempt or covered by a Common Plan of Development, any development or redevelopment activity, including demolition and reconstruction of impervious surfaces that produce stormwater runoff, is subject to the performance standards of this manual.

1.5.1. Exemptions

1. Development and/or Redevelopment Activities

- a. Projects involving development/redevelopment of less than 3,000 square feet of impervious and semi-impervious surface. The cumulative development/redevelopment area and activity will be tracked based on the project or parcel. The applicant will only be allowed to apply this threshold to a cumulative construction area not exceeding 3,000 square feet. For purposes of this exemption, gravel, or shell, uncompacted and not subject to vehicular use, is not included in determining the area of impervious and semi-impervious surface.
- b. Small Sites, parcels that are one acre or less, will qualify for water quality exemptions when:
 - i. The existing impervious area is reduced by at least 10%, and
 - ii. Presumptive treatment criteria of 0.5" for dry retention and 1" for wet detention over the entire parcel area is met, and
 - iii. The 10% reduction area is dedicated to the incorporation of green infrastructure in addition to the presumptive volume:
 - 1) Bioswales/Treatment Swales/Green Gutters
 - 2) Pervious Pavement Systems
 - 3) Rain Gardens
 - 4) Tree Boxes
 - 5) Other area or volumetric-based BMPs may be considered on a case-by-case basis.

Parcels will only qualify for this exemption once, all subsequent development/redevelopment will be required to meet full water quality treatment standards tracked cumulatively in 1.5.1.1.a. 2. Single family residences, Duplex residences, or Triplex residents are exempt from providing stormwater treatment and attenuation, if:

- a. They are not part of a larger plan of development which includes stormwater management (e.g. a subdivision),
- b. They do not exceed 10,000 square feet of impervious area, or
- c. The impervious area does not exceed 25% of the site acreage for sites larger than one acre.

Subdivisions meeting the Minor Plat provisions in the Land Development Code, LDC 154-265 shall provide 1-inch rainfall volumetric retention requirement for the entire lot area through the utilization of vegetated swales (e.g. turf of planted), rain gardens, bio-swales or dry retention areas.

3. The development of a lot that was previously approved as part of a commercial development or common plan of development if all the following apply:
 - a. A permitted development was never constructed on the lot. (Subsequent redevelopment of the lot will be required to meet the performance standards of this manual.)
 - b. The master stormwater management system was constructed in accordance with and is still in compliance with the master stormwater management system design.
 - c. The time limits on active permits are in accordance with [Section 138.180 of the Land Development code](#).
4. Renovations to the exterior surfaces of existing buildings such as roofs or facades.
5. Minor roadway safety construction, alteration, or maintenance, including:
 - a. Turn lanes less than 0.25 mile in length;
 - b. Road widening and shoulder paving that does not create additional traffic lanes and is necessary to meet current, generally accepted roadway design and safety standards; and
 - c. Minor increases in impervious surfaces constructed for public safety improvements that are not subject to vehicular use within the right of way of public or private roadways such as multiuse pathways, sidewalks, or installation of guardrails; and
 - d. Intersection improvements adding less than 4,000 square feet of impervious surface area.
6. Resurfacing or rehabilitation of existing paved roads, and grading of existing unpaved roads, provided:
 - a. Travel lanes are not paved that are not already paved; and
 - b. No substantive changes occur to existing road surface elevations, grades, or profiles.
7. Repair, stabilization, or paving of existing unpaved roads, and the repair or replacement of vehicular bridges that are part of the unpaved road, provided:
 - a. The work does not realign the road or expand the number of traffic lanes of the existing road, but may include safety shoulders, clearing vegetation, and other work reasonably necessary to repair, stabilize, or pave the road, provided that the work is constructed using generally accepted roadway design standards;
 - b. Existing bridges are not widened more than is reasonably necessary to properly connect the bridge with the road to match the width of the roadway travel lanes and meet the other standards for roads and bridges referenced in this manual;
 - c. Roadside swales or other effective means of stormwater treatment are incorporated as part of the work to the maximum extent practicable; and
 - d. No more dredging or filling of wetlands or water of the state is performed than is reasonably necessary to perform the work in accordance with generally accepted roadway design standards and the work complies with [Chapter 166 of the County's Land Development Code](#).
8. Any activity which in the opinion of the county is strictly related to maintenance and repair of existing facilities.

9. Manufactured or Mobile Homes: individual manufactured homes shall be treated as a single-family residential unit/lot and the remaining property within the rest of the park shall be treated as a commercial lot, subject to the additional standards as presented below.

a) Manufactured or Mobile Home Unit/Lot

- Each replacement shall follow the setback requirements as described in [138-375 of the County's Land Development Code](#) or a previously County approved site plan or lot layout.
- Each replacement shall follow the applicable fire code and building code requirements in place at the time of the replacement.
- Each replacement shall not exceed a maximum impervious area to total area ratio of 0.75 on each individual manufactured or mobile home lot.
- Each replacement shall provide qualitative improvements on each individual lot. Example of qualitative improvements include disconnection of impervious areas and depressing green space to provide opportunities for stormwater runoff to percolate. Examples of these options shall be provided to the applicant.
- These standards only apply when the replacement of a unit is NOT part of a larger redevelopment plan. If a larger redevelopment is planned for the manufactured or mobile home park, it shall be treated as a non-single-family redevelopment plan.

b.) Manufactured or Mobile Home Park (owned by one entity or a group of individuals, separate from the individual unit ownership)

- Redevelopment of all areas outside of each individual manufactured or mobile home lot shall follow the same requirements as non-single-family residential redevelopment.
- The redeveloped area shall demonstrate quantitative improvements as required by the standards set forth in this Pinellas County Stormwater Manual.
- The maximum allowable exemption on projects involving development or redevelopment of less than 3,000 square feet of impervious and semi-impervious surface shall apply. The cumulative construction area and activity will be tracked based on the project or parcel. The applicant will only be allowed to apply this threshold to a cumulative construction area not exceeding 3,000 SF. For purposes of this exemption, gravel or shell, un-compacted and not subject to vehicular use, is not included in determining the area of impervious and semi-impervious surface.

1.5.2. Redevelopment Projects

Redevelopment projects are required to meet the same flood control and stormwater treatment standards as new development for that portion of the project where construction is proposed. Any portions of the site that are redeveloped will be constructed to comply with the provisions of this Manual.

1.5.3. Administrative Adjustments and Variances

In addition to other code criteria, projects qualifying for an Administrative Adjustment and/or Variance under this subsection must demonstrate that (a) the level of flood management meets the County

requirements and (b) the level of treatment proposed demonstrates best engineering efforts to comply with the applicable treatment criteria.

Requests for an Administrative Adjustment and/or Variance from any Standard or Criteria described in this manual may be approved by the County based on a submitted technical analysis which considers the applicability of current available treatment technologies relative to:

1. The current and proposed land use and level of imperviousness,
2. Physical site constraints such as soil and water table characteristics,
3. Hydraulic constraints such as tailwater elevations,
4. Connections to existing infrastructure,
5. Other County requirements (e.g., zoning, land use restrictions,) which might limit or provide opportunities for locating stormwater management facilities onsite, and/or
6. Opportunities for offsite treatment, including the availability of regional facilities.

1.5.3.1 Administrative Adjustments

Administrative Adjustments may be granted to the following, unless specifically noted herein:

1. Stormwater dimensional requirements may be adjusted up to 20 percent.
2. Stormwater quality requirements may be adjusted up to 10 percent.

Administrative Adjustment from the standards in Chapter 3 Stormwater Quality Permitting Requirements may be granted on a case-by-case basis based on the Small Site or Large Site Criteria.

Small Sites, parcels less than 1 acre:

Small Sites are eligible for up to a 10% administrative decrease in water quality required if they meet the following criteria:

- Demonstrate with calculations a net improvement in nutrient reduction, and
- Presumptive water quality criteria of 0.5" for dry ponds and 1" for wet ponds over the entire parcel area are provided,
- The project incorporates a minimum of 2 of the 4 following types of Green Infrastructure on site:
 - Bioswales/Treatment Swales/Green Gutters
 - Pervious Pavement Systems
 - Rain Gardens
 - Tree Boxes

Large Sites, parcels greater than 1 acre:

Large Sites are eligible for up to a 10% administrative decrease in water quality required if they meet the following criteria:

- Demonstrate with calculations a net improvement in nutrient reduction, and

- Presumptive water quality criteria of 0.5” for dry ponds and 1” for wet ponds over the entire parcel area are provided,
- The project incorporates a minimum of 2 of the 4 following types of Green Infrastructure on site:
 - Bioswales/Treatment Swales/Green Gutters
 - Pervious Pavement Systems
 - Rain Gardens
 - Tree Boxes

Large Sites, parcels greater than 1 acre:

Large Sites are eligible for up to a 20% administrative decrease in water quality required if they meet the following criteria:

- Provide an additional 20% landscape area and plantings above landscape code minimum, and
- The 20% increased landscape area is dedicated to the incorporation of green infrastructure:
 - Rain Gardens,
 - Tree Wells,
 - Bioswales,
 - Other area or volumetric-based BMPs may be considered on a case-by-case basis.
- Demonstrate with calculations a net improvement in nutrient reduction.

1.5.3.2 Variances

An applicant may seek deviations and/or adjustments from the dimensional and technical provisions of this Code other than those already listed as Administrative Adjustments as a Variance. Variances as described in this Manual are processed in accordance with Land Development Code Chapter 138-235

The minimum acceptable level of treatment will reduce the post-development annual average stormwater total nitrogen and phosphorus loads to a level less than the loads currently discharged from the site (net improvement). The County will review the submitted technical feasibility analysis and determine the final level of treatment that will be required for the project.

1.5.4. Transportation Stormwater Management Systems

1.5.4.1. General Requirements

Transportation stormwater management systems will conform to the general requirements of the [Pinellas County Comprehensive Plan](#), [Pinellas County Code](#), and the [County Transportation Design Manual](#), but otherwise should be designed and constructed in accordance with the practices, procedures and criteria established by the Florida Department of Transportation.

1.5.4.2. Design Frequency

The Table below summarizes the minimum design frequencies for use on County transportation facilities. These design frequencies are generally referenced in the [FDOT Drainage Manual](#) however no open or closed conveyance systems will be designed below the 10-year frequency. The most current versions of the references listed in [Section 1.5.4.3](#) will be utilized when designing stormwater managementsystems for transportation projects.

Facility	Frequency
Roadside, Median and Collector ditches or swales	10-year
Outfall ditches, Major Channels and Canals	25-year
Storm Drains (also applies to parking areas)	10-year
Bridges and Cross Drains on Evacuation Routes	100-year
Bridges and Cross Drains on Arterial and High-Use (ADT > 1,500) Roads	50-year
Bridges and Cross Drains on all Other Roads and Facilities	25-years
Roadside Ditch Culverts	10-year

The frequencies cited by the table above are minimums. Higher design frequencies will be used where Level of Service (LOS) requirements prevail, or Master Plan Goals warrant use of such. Examples of this are situations where structural flooding LOS concerns may entail consideration of the 100-year design frequency and requirement to complete design in accordance with future improvements identified by Stormwater Master Plans or Watershed Management Plans.

The proposed project will also demonstrate that the inlet spacing is sufficient to maintain the spread in accordance with the standards in the Florida Greenbook.

1.5.4.3. References

The current editions of the following documents are referenced for design of County transportation stormwater management facilities (in order of precedence):

- [Pinellas County Standard Technical Specifications for Roadway and General Construction](#)
- [Pinellas County Transportation Design Manual](#)
- [Pinellas County Standard Details](#)
- [Manual of Uniform Minimum Standards for Design, Construction and Maintenance for Streets and Highways \(Florida Greenbook\)](#)
- [The Florida Department of Transportation Standard Specifications](#)
- [The Florida Department of Transportation Design Manual](#)
- [The Florida Department of Transportation Standard Specifications](#)
- [The Florida Department of Transportation Drainage Manual](#)
- [The Florida Department of Transportation Drainage Design Guide](#)

1.5.4.4. Minimum Elevation

The minimum edge of pavement elevation for new road construction will be whichever is more stringent of the following criteria:

- The minimum edge of pavement elevation is five feet above mean sea level (NAVD88), or
- The lowest edge of pavement will be above the 25-year storm event as indicated in the current stormwater management plan (stormwater master plan or watershed management plan).

1.5.5. General Stormwater Requirements

1.5.5.1. Connections.

Stormwater connections to other stormwater systems will be designed and aligned to minimize hydraulic losses and prevent erosion and siltation. Stormwater connections will minimize adverse impacts to the maintainability of the stormwater management system or its service life. The method of connection and requirements for erosion and sediment control will be suitably detailed by the plans.

Regardless of whether a site is exempt from the other requirements of this Manual, roof drains/gutter downspouts will not be directly connected to the stormwater conveyance system (inlets, pipes, ditches, swales), but shall be directed to stormwater treatment facilities or overland for percolation prior to flowing into the conveyance system.

Connections to Existing County-owned piped stormwater network will meet the following criteria:

1. Attenuation - In areas of unincorporated Pinellas County with only a tidal floodplain component and/or areas where County created attenuation is provided in a Master Stormwater Management System (e.g., Palm Harbor), discharges from sites that connect to piped stormwater systems are not required to be attenuated to the 25-year 24-hour design storm. However, the downstream conveyance system must contain the system design storm per the Stormwater Manual, section [1.5.4.2, Design Frequency](#), within the allowable pavement spread limits.
2. Treatment – Areas which are designated to be within a County created Master Stormwater Management System area are exempt from treatment criteria of the Stormwater Manual, Section [3.1.1, General Performance Standards](#), to the extent that treatment and/or nutrient reduction has been provided.

1.5.5.2 Formalization of Stormwater in Alleys

1. Unpaved alleys shall be paved by each development proposing connection from the development access point to the nearest section of paved road.
2. Alleys with inverted crown pavement sections shall be designed, utilizing Manning's equation, to keep the design storm within the edges of pavement. When the combined design runoff of the alley and the intersecting street exceeds the allowable street capacity or spread, inlets shall be used in the alley.

1.5.5.3. Floodplains.

The floodplain standards are established and required in the following:

[Pinellas County Code, Part III – Land Development Code Chapter 158 – Floodplain Management.](#)

1.5.5.4. Compliance with other specifications.

Stormwater plans, profiles, cross sections, and details, including detention facilities and underdrains, will meet all minimum standards of applicable County Codes and other ordinances and regulations with the preliminary plat. A master lot grading plan will be included. Stormwater calculations will be furnished. Hydraulic calculations for all closed storm sewer systems will be prepared and submitted utilizing a standard Pinellas County or FDOT storm sewer tabulation form.

1.5.5.5. Stormwater review.

Prior to issuance of building permits, including for single family residences excluded in 1.5.1., the County will review and make a determination whether the proposed project has the potential to significantly change the stormwater patterns in and around the property or cause adverse impact offsite.

The County Administrator may establish administrative procedures for departments to conduct such stormwater reviews. The stormwater (drainage) review standards are established and required in the following:

- [Pinellas County Code, Part III Land Development Code - Chapter 138 – Article X – Community DesignStandards – Division 1](#)
- [Pinellas County Code, Part III Land Development Code - Chapter 154](#)

1.5.5.6. Diversion of surface runoff.

Surface water runoff will not be diverted across the major watershed basin boundaries as depicted in the County Stormwater Master Plan (SWMP), Watershed Management Plans or best available data. In situations where runoff from an area may contribute to more than one basin, the post-development discharge of runoff will match the pre-development discharge characteristics.

1.5.5.7. Basin map.

A watershed map of the basin or basins within which the development lies, inclusive of immediate off-site drainage, must be provided. This map may be combined with the topographic map required under County Code, but in any event must include suitable topographic data acceptable to the County Administrator or designee. All ridges outlining the basins and the sizes of the basins in acres must be shown. The outlines and sizes in acres of all existing and proposed drainage areas within the basin will be shown and related to corresponding points of flow concentration. Flow paths and existing stormwater infrastructure will be indicated throughout, including final outfalls from the subdivision and basins.

1.5.5.8. Stormwater data.

Stormwater data assumed criteria and hydrologic and hydraulic calculations will be provided to the county and will meet the requirements of County Code and this manual.

Storm Tabulations and Gutter Spread calculations will adhere to the following criteria:

1. Storm Tabulations per section 1.5.5.4 (other storm sewer tabulations may be acceptable).
 - a. Projects which do not require on-site retention shall provide a full stormwater tabulation model from the site to the outfall of a retention/detention pond or waterway, or
 - b. Provide attenuation of the closed system design storm.
2. Spread Criteria per the [FDOT Drainage Manual Section 3.9.1](#) shall apply.
3. On site retention or detention may be used to delay the peak flow through the closed system in order to reduce the pavement spread to allowable levels.

1.5.5.9. Rainfall criteria.

1. The FDOT Rainfall Intensity-Duration-Frequency (IDF) Curves for Zone 6 (see Appendix A) will be used when designing by the Rational or Modified Rational Methods. For application to these methods, the duration used will be the calculated time of concentration (T_c), subject to a minimum of 10 minutes.
2. The rainfall depths shown in Appendix B are to be used for SCS Methods. The allowable rainfall distribution is the SCS Type II Modified rainfall distribution. This distribution can be found in Table B-1 in Appendix B. It will be used in both the pre- and post- development runoff hydrographs. The peaking factor for both pre- and post-development conditions will be 256, unless otherwise justified.

1.5.5.10. Tailwater Considerations

“Tailwater” refers to the receiving water elevation at the final discharge point of the stormwater management system. Tailwater is an important component of the design and operation of nearly all stormwater management systems and can affect any of the following characteristics of the system:

- Peak discharge,
- Peak stage,
- Level of flood protection,
- Recovery of peak attenuation and stormwater treatment volumes, and/or
- Control elevations, normal water elevation regulation schedules, and groundwater management. Future conditions at the receiving water.

The following criteria are provided as guidance in the design of stormwater management systems:

1. **Water quality.** All systems must provide a gravity discharge that effectively operates under normally expected tailwater conditions. Consideration should be given to systems discharging to tidal water bodies will be functional during the Mean Higher High Water (MHHW) level of normal diurnal tides, spring tides, and water levels elevated by normal sustained wind patterns. Systems discharging to non-tidal areas will be designed to be functional throughout the wet season. Determination of the wet season high water table based on geotechnical and/or biological indicators as well as observable stain lines should be used to support and document the tailwater used for design.
2. **Water quantity.** All systems must, in addition to the provisions of water quality, be designed to be functional for all tailwater conditions that may be encountered by events equal in frequency to the design storm event. This may entail consideration of storm durations different than the standard 24-hour storm event. Variable tailwater stages should be considered if they have a significant influence on the design.
3. **Regulated systems.** Design and regulated stage elevations should be available from either the local jurisdiction or SWFWMD.
4. **Sea level rise projections as recommended by the Tampa Bay Climate Science Advisory Panel.** This includes the April 2019 edition of *Recommended Projection of Sea Level Rise in the Tampa Bay Region* or the latest edition thereof.
5. **Pinellas County requires a minimum tailwater elevation of 3.0 ft. NAVD88 for non-critical**

infrastructure and 4.0 ft. NAVD88 for critical infrastructure. Applicants may propose to utilize alternative tailwater elevations due to site-specific constraints but should take into account current and future conditions at the receiving water.

1.5.5.11. Retention/detention facilities.

The characteristics of retention/detention facilities will be designed as follows:

1. Side bank slopes of retention/detention facilities will not be steeper than a slope of four feet horizontal to one foot vertical (4:1) to a point 2 feet below the normal water level. Below this point, the maximum side slope will be two horizontal to one vertical (2:1) below normal water level. Facilities that cannot meet these criteria, with side bank slopes steeper than 4:1, must not have slopes greater than 3:1, and must be surrounded by a six-foot chain-link fence or other protection sufficient to prevent accidental incursion into the retention or detention area. In determining the sufficiency of other protection measures, consideration will be given to the depth and layout of the detention or retention area, surrounding land uses, degree of public access, and likelihood of accidental incursion.

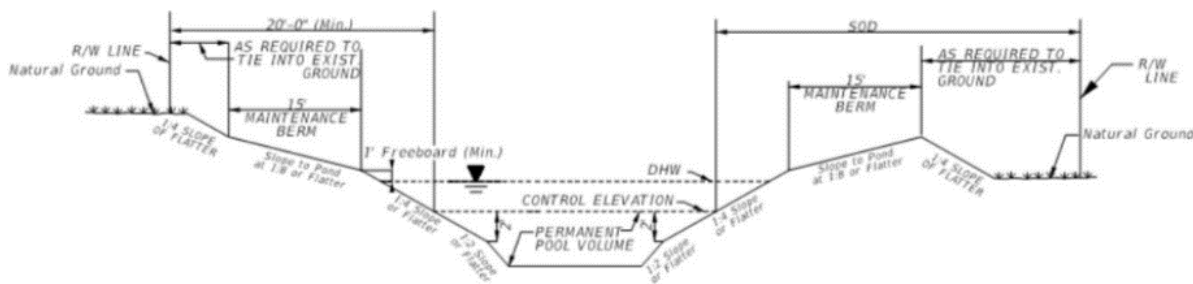

Figure 1.5.1: Typical section for a pond and the side slopes

2. Vertical walls, or side slopes steeper than 3:1, will be considered as a last resort BMP if the site layout constrains the use of more natural BMPs as described above. Vertical walls will not be permitted around more than 25 percent of the perimeter of wet detention ponds or more than 50 percent of the perimeter of dry retention ponds.
3. At least 50 percent of the surface area of a wet detention treatment pond must be open to sunlight.
4. One foot of freeboard is recommended for all stormwater retention/detention facilities. A minimum of six inches of freeboard shall be required from the required design storm peak stage to the top of bank for all retention/detention facilities. For a 100-year 24-hour peak stage above TOB provide emergency spillway with velocity less than 2 ft/s.
5. An applicant may propose alternative criteria than those listed herein if they can demonstrate that their alternative criteria address the following concerns:

Provides a safe means for ingress and egress into the facility, reduces the risks associated with steep banks and vertical walls.

Demonstrates the ability to maintain the alternate design with standard equipment and techniques and validates that the alternative will not compromise the performance standards of the facility through the use of monitoring, modeling, or other scientifically defensible methods.

1.5.5.12. Stormwater outfalls

1. Positive and adequate outfalls are required for all proposed or existing stormwater systems. Documentation showing that existing outfalls are both positive and adequate may be required.

2. Stormwater walls, seepage basins, sinkholes, pumps or underdrains are not considered positive outfalls.

For public safety reasons, discharge of sheet-flow over sidewalks or other pedestrian pathways is not considered an adequate outfall.

3. On a case-by-case basis, requests to allow up to 10% of the modeled infiltration from the pond bottom to be included in the attenuation analysis for sites less than 5 acres may be considered, at County staff's discretion. There are few areas of the County where this may be a viable option, to be confirmed by County staff. Additional testing/data is required to be submitted if pursuing this option.

In cases in which alternative outfalls have been determined appropriate the following criteria will apply:

Soil investigation and percolation

1. Results of all percolation and soils investigations shall be certified by a Florida Registered Professional Engineer with expertise in soil science and geotechnical engineering.
2. Sufficient test borings will be collected by a certified testing firm, to a minimum depth of 10 feet below the bottom elevation of the basin in order to determine the groundwater table and soil classifications.
3. There shall be at least one soils investigation per 10,000 square feet of pond bottom and one infiltration test per 20,000 square feet of pond bottom, placed at appropriate locations, provided that the entire pond area consists of the same soils type as identified in the SCS soils survey of Pinellas County. If multiple ponds are used, one soil boring and infiltration test will be required per pond, regardless of the size. In addition, multiple borings or tests immediately adjacent to each other will not be accepted.
4. Retention ponds shall have at least one infiltration rate test performed for each 1/4 acre of pond bottom if percolation will be through the pond bottom. Or there shall be a minimum of one infiltration rate test performed for each BMP which ever results in more test.
5. The infiltration rate test – Double Ring Infiltrometer (DRI) Test – shall be ASTM Standard Method D3385-09. Percolation tests shall not be made in filled ground unless the soil has been thoroughly and mechanically compacted or allowed to settle for a period of six months or more. The adjusted field rate for the DRI test may be used on the bottom of the pond/basin and 50 percent of the horizontal component of the sides.
6. The percolation rate shall be reduced by 10 percent for each foot the water table rises above the elevation of 10 feet below the bottom of the pond/basin. The maximum allowable percolation rate after adjustment for water table elevation is 1.5 feet/hour.
7. The representative field infiltration rate shall be the lowest percolation rate determined from field test.
8. The infiltration rate test shall be performed at the depth and location which will provide representative test results for use in design of the retention pond.
9. The subsoil investigation report shall provide detailed information on all test procedures, test depths and locations and data measurements and results.

Design

1. The retention pond design shall be based on an infiltration rate that is no greater than 3/4 of the

- lowest infiltration rate obtained from the soils investigation tests, with the maximum allowable final design rate not to exceed 1.5 feet/hour (18 inches per hour).
2. Stormwater system recovery must be demonstrated using a computer model which includes consideration of the groundwater mounding effect. The storage volume shall recover within the 72-hour period. Percolation calculations shall include analysis of both horizontal and vertical movement of water within the water table and any other effect that the seasonal high-water table may have on infiltration capacity, including mounding analysis.
 3. In all cases, the minimum distance between the pond bottom and the seasonal high groundwater table shall be at least 1 foot.
 4. The site shall be designed with attention to a "fail safe" approach, to ensure that any potential pond overflows can be conveyed or otherwise accommodated with no adverse impacts or damage to adjacent properties, and no danger to public safety.

Maintenance

1. A program for proper maintenance of the interior of the vault or drain field to preclude a reduction of its capacity or the rate of percolation, and to prevent the facility from becoming a nuisance must be provided.
2. Where percolation from a pond bottom is to be considered as an alternative outfall, the final six inches of grading shall not be completed until the development has been constructed. This procedure shall be included in the stormwater management plan and stated on the construction plans.
3. Additional scarifying or sediment removal may need to be performed for percolation ponds to ensure that the system will meet the specified infiltration rates and storage volume. Every project must provide a plan which shall include:
 - a. A program for proper maintenance of the bottom and sides of the retention basin to preclude silting up of the basin which would reduce its capacity or reduce the rate of percolation, and to prevent the basin from becoming a nuisance. Ponds with vegetation plans must have a maintenance element to those plans.

Construction

1. The location of retention basins will be clearly marked at the site to prevent unnecessary vehicular traffic across the area causing soil compaction.
2. Initially construct the retention basin by excavating the basin bottom and sides to approximately 12 inches above final design grades. Excavation shall be performed with light weight equipment to minimize compaction. A system to distribute the equipment weight such as sheet wood or steel shall be provided by the contractor to the Engineer of Record for review and approval.
3. Excavation will be done by lightweight equipment to minimize soil compaction. Tracked, cleated equipment does less soil compaction than equipment with tires.
4. After the watershed area contributing to the basin, has been fully stabilized, the interior side slopes and basin bottom will be excavated to final design specifications. The excess soil and undesirable material must be carefully excavated and removed from the basin so that all accumulated silts, clays, organics, and other fine sediment material has been removed from the pond area. The excavated material will be disposed of in a manner that assures it will not re-enter the retention basin.
5. Once the basin has been excavated to final grade, the entire basin bottom must be deep raked

and loosened for optimal infiltration. The depth to be raked is dependent on the type, weight and contact pressure of the construction equipment used during the bulk excavation of the basin.

6. Where percolation from a pond bottom is to be considered, the final 6 inches of grading shall remain in place until the development has been constructed or the pond shall be over-excavated, and sediment removed prior to the final 6" of clean material placed. This procedure shall be included in the stormwater management plan.

1.5.5.13. Hydraulics of minor streams, canals, ditches, and swales.

1. "Open channels" other than major waterways, such as minor streams, canals, ditches, and swales, will be designed in accordance with good, accepted engineering practices adapted to local conditions. Cross-sectional areas and hydraulic gradients will be such that design velocities will not result in soil scouring for the soil and/or turf conditions reasonably anticipated. Mean velocities greater than three feet per second will be considered excessive unless permanent channel lining or other suitable protection is employed.
2. The design of open channels described in this section will provide that the channels will not overflow their banks at design flood conditions.

1.5.5.14. Major channels.

Where development may adversely affect an existing major channel, the required improvements to the channel will conform to an adopted County stormwater master plan or watershed management plans for the various watershed basins. Improvement or establishment of major canals is of such significance to the county that the design of each such improvement or establishment proposed will be developed as a separate hydraulic problem. Any deviations from the construction shown on the stormwater management plan will require that engineering data, criteria and suitable calculations demonstrating that there are no adverse impacts as a result of the improvements will be submitted prior to approval of site and/or construction plans.

1.5.5.15. Canals, lakes, ponds, major channels.

1. Lakes and ponds will have a maximum side slope of four to one (4:1) to a point two feet below normal water level and two to one (2:1) below normal water level.
2. To the extent allowed by State and County regulations, maximum use will be made of constructed lakes and retention and/or detention ponds.
3. Where lakes and/or ponds are used for retention or detention, an identification of the seasonal high-water table will accompany design calculations.
4. Where lakes are included as a part of the stormwater system, detention time in these lakes may be considered in computing discharge by presentation of hydrographs developed with accepted engineering methods.

Where the development abuts the centerline of the natural drainageway, natural area or water body it will be used as a site plan property line. Where a natural drainageway, natural area or water body separates the same ownership, and no project is to be submitted for the opposite side of the natural drainageway, natural area or water body then the centerline of the natural drainageway, natural

area or water body will be used as the site plan line.

1.5.5.16. Swales

1. *Roadside swale geometry.* Side slopes of roadside swales/ditches will be no steeper than four to one within the roadway clear zone or three to one elsewhere. The minimum shoulder width for new roadways will be eight feet or, if greater, as required by the *Manual of Uniform Minimum Standards for Design, Construction and Maintenance for Streets and Highways (Florida Greenbook)* current edition. Swales and sidewalks will be located within the road right-of-way. Minimum bottom width of swales will be two feet, and the minimum depth of swales interconnected by side drains will be 18 inches below the edge of the pavement. Minimum bottom widths of swales less than two feet can be accommodated as long as proper hydraulic function and the ability to properly maintain the swale is not compromised. The minimum depth of retention swales or swales associated with pipe collection systems that enable a shallower design (e.g., swale over pipe systems and swales upstream of pipe) will be sufficient to assure no flooding of the edge of pavement or adjacent properties during the design storm event. The design of roadway stormwater swales will consider potential impacts to the roadway base system. Swales will be designed to take into account the soil erodibility, soil percolation, slope, slope length, and drainage area so as to prevent erosion and reduce pollutant concentration of any discharge.
2. *Constrained Right-of-Ways.* For roadways constrained by existing rights-of-way, shoulder and roadside swale design will conform to the minimum requirements of the *Manual of Uniform Minimum Standards for Design, Construction and Maintenance for Streets and Highways (Florida Greenbook, FDOT)*. Where this is not possible, shoulder and swale design may be further reduced to the minimums cited by A Policy on Geometric Design of Highways and Streets, American Association of State Highway Transportation Officials (AASHTO) following approval of the County Engineer.
3. *Yard swales.* For local lot drainage, rear yard swales are not acceptable when traversing more than one lot. Yard drains and inlets are required where necessary for adequate drainage. The design for yard swales must be adequately addressed by the site plan.
4. Where side yard swales and other swales are required, side slopes will be not steeper than five to one for subdivisions and three to one for commercial sites. Minimum depth of swales will be six inches. Minimum gradients of yard swales will be one-eighth inch per foot (one percent). Vertical rise from high point of swale to lowest floor level will be not less than eight inches.

1.5.5.17. Swale erosion protection.

1. Swales will be provided with permanent erosion protection. Such protection may be turf (natural turfgrass, no synthetic turf allowed), using an approved type of grass, other approved vegetation, or an approved type of pavement liner. Sodding, if used, will begin one foot from the roadway edge-of-pavement and extend to the top of the swale backslope.
2. Driveways across swales will either be constructed with slopes to match the grade of the swale or have reinforced concrete pipes of adequate size for drainage, a minimum of 15 inches placed beneath them. The culvert pipes will be long enough to provide a shoulder on each side of the driveway. The minimum shoulder width will be six feet for all driveways unless it is demonstrated that a reduced shoulder width will not create a driveway safety or roadway operational risk. The ends of the pipe will be finished with mitered end sections per Florida Department of Transportation standards.
3. All slopes will be stabilized to prevent erosion.

1.5.5.18. Detention areas, grading.

Detention areas must be roughed out prior to other site grading as a means of sediment and erosion control.

1.5.5.19. Use of water for on-site irrigation.

Water retained or detained as part of the water quantity or water quality treatment volume may be pumped onto land for onsite irrigation purposes from which surface water runoff returns to the same retention/detention area.

1.5.5.20 Fences and Walls

Regardless of whether a site is exempt from the other requirements of this Manual, fences and walls cannot be constructed in a manner that restricts stormwater flows (either historic or new flows).

1.5.5.21 Regional Stormwater Facilities

Off-site attenuation and treatment of stormwater via a nearby regional stormwater facility may be possible, if deemed acceptable by the County. The buy-in price will be specific to the regional stormwater facility being utilized and will require written agreement with both the facility and the County. Documentation required includes but is not limited to proof of necessary permits, volume attenuated, and level treatment provided.

1.5.5.22 No Adverse Impact to Neighboring Properties

Regardless of whether a site is exempt from the other requirements of this Manual, no development/redevelopment activity will cause adverse impacts or send additional runoff to adjacent/neighboring properties, to be confirmed by County review staff.

1.6. County-Owned/Operated Stormwater Systems

County-owned and operated stormwater systems will be designed and constructed in accordance with the County's standards, including those presented in this stormwater manual along with the standard details and technical specifications available at <https://pinellas.gov/technical-resources/>.

1.7. Erosion and Sediment Control

1.7.1 Overview

Uncontrolled erosion and sediment from land development activities can result in costly damage to aquatic areas and to both private and public lands. Excessive sediment blocks stormwater conveyance systems, plugs culverts, fills navigable channels, impairs fish spawning, clogs the gills of fish and invertebrates, and suppresses aquatic life.

A plan for minimizing erosion and controlling sediment through the implementation of appropriate BMPs must be included with the application for a stormwater treatment permit. Note that in addition to the "erosion and sediment control plan", all projects that disturb one or more acre of land that discharge to waters or a permitted Municipal Separate Storm Sewer System will also need to develop and implement a Stormwater Pollution Prevention Plan (SWPPP) to obtain coverage under Florida's NPDES Generic Permit for Stormwater Discharge from Large and Small Construction Activities.

An effective sediment and erosion control plan is essential for controlling stormwater pollution during construction. An erosion and sediment control plan is a site-specific plan that specifies the location, installation, and maintenance of best management practices to prevent and control erosion and sediment loss at a construction site. The plan is submitted as part of the permit application and must be clearly shown on the construction plans for the development. Erosion and sediment control plans range from very simple for small, single-phase developments, to complex for large, multiple phased projects. If, because of unforeseen circumstances such as extreme rainfall events or construction delays, the proposed erosion and sedimentation controls no longer provide reasonable assurance that water quality standards will not be violated, additional erosion and sediment control measures will be required that must be designed and implemented to prevent violations of water quality standards.

1.7.2 Erosion and Sediment Control Requirements

Erosion and sediment control Best Management Practices (BMPs) will be used as necessary during construction to retain sediment on-site and assure that any discharges from the site do not cause or contribute to a violation of Florida's turbidity standard (29 NTU above background or 0 NTU above background in an Outstanding Florida Water (OFW)). These management practices must be designed according to specific site conditions and will be shown or clearly referenced on the construction plans for the development. At a minimum, the erosion and sediment control requirements described in this section will be followed during construction of the project. Additional measures are required, if necessary, to protect wetlands or prevent off-site flooding. All appropriate contractors must be furnished with the information pertaining to the implementation, operation, and maintenance of the erosion and sediment control plan. In addition, sediment accumulation in the stormwater system from construction activities must be removed prior to final certification of the system to ensure that the designed and permitted storage volume is available.

1.7.3 Erosion and Sediment Control Principles

Factors that influence erosion potential include soil characteristics, vegetative cover, topography, climatic conditions, timing of construction, and the areal extent of land clearing activities. The following principles must be considered in planning and undertaking construction and alteration of surface water management systems:

- (a) Plan the development to fit topography, soils, watershed patterns, and vegetation;
- (b) Minimize both the extent of area exposed at one time and the duration of exposure;
- (c) Schedule activities during the dry season or during dry periods whenever possible to reduce the erosion potential;
- (d) Apply erosion control practices to minimize erosion from disturbed areas;
- (e) Apply perimeter controls to protect disturbed areas from off-site runoff and to trap eroded material on-site to prevent sedimentation in downstream areas;
- (f) Keep runoff velocities low and retain runoff on-site;
- (g) Stabilize disturbed areas immediately after final grade has been attained or during Interim periods of inactivity resulting from construction delays; and
- (h) Implement a thorough maintenance and follow-up program.

These principles are usually integrated into a system of vegetative and structural measures, along with other management techniques, that are included in an erosion and sediment control plan to minimize erosion and control movement of sediment. In most cases, a combination of limited clearing and grading,

limited time of exposure, and a judicious selection of erosion control practices and sediment trapping systems will prove to be the most practical method of controlling erosion and the associated production and transport of sediment. Permit applicants, system designers, and contractors can refer to the *State of Florida Erosion and Sediment Control Designer and Reviewer Manual (June 2013)*, as revised and the *Florida Stormwater, Erosion, and Sediment Control Inspector's Manual (FDEP 2008)*, as revised for further information on erosion and sediment control. These manuals provide guidance for the planning, design, construction, and maintenance of erosion and sediment control practices. Copies of the *State of Florida Erosion and Sediment Control Designer and Reviewer Manual* are at: <http://stormwater.ucf.edu/fileRepository/docs/2013RevisedDesignerManual.pdf>

Copies of *The Florida Stormwater, Erosion, and Sediment Control Inspector's Manual* can be obtained upon request from the Florida Department of Environmental Protection, Nonpoint Source Management Section, M.S. 3570, 2600 Blair Stone Road, Tallahassee, Florida 32399-2400 (phone 850-245-7508). Copies of the above documents are also available at: <http://www.dep.state.fl.us/water/nonpoint/docs/erosion/erosion-inspectors-manual.pdf>

1.7.4. Development of an Erosion and Sediment Control Plan

An erosion and sediment control plan must be submitted to the County to provide reasonable assurance that water quality standards will not be violated during the construction phase of a project. The plan must identify the location, relative timing, and specifications for all erosion and sediment control and stabilization measures that will be implemented as part of the project's construction. The plan must provide for compliance with the terms and schedule of implementing the proposed project, beginning with the initiation of construction activities. The plan may be submitted as a separate document or may be contained as part of the plans and specifications of the construction documents.

1.7.5. Development of a Stormwater Pollution Prevention Plan (SWPPP) for NPDES Requirements

Since Pinellas County has been issued a NPDES Municipal Separate Storm Sewer System (MS4) permit, the county staff must assure that all construction sites comply with the State of Florida's NPDES Construction Generic Permit (CGP) pursuant to subsection [62-621.300\(4\), F.A.C.](#) Construction activities resulting in greater than one-acre of soil disturbance must also apply for and receive coverage from FDEP under Florida's NPDES Construction Generic Permit before disturbing the soil.

1.7.6. Additional Requirements of the Construction Generic Permit

The NPDES Construction Generic Permit (CGP) is adopted by reference in Chapter 62-621.300(4), F.A.C., and is available online at: <http://www.dep.state.fl.us/water/stormwater/npdes/construction3.htm>

The CGP consists of the following nine parts:

- Part 1 – Permit Coverage
- Part 2 – Your Application (Notice of Intent)
- Part 3 – Discharges
- Part 4 – Stormwater Pollution Prevention Plan (SWPPP)
- Part 5 – Best Management Practices (BMPs)
- Part 6 – Inspections and Records
- Part 7 – Completion (Notice of Termination)
- Part 8 – Definitions and Acronyms

1.8. Inspection and Recertification of Stormwater Treatment Systems

Stormwater treatment and management systems must be inspected and maintained on a regular basis as set forth in this Manual to assure that such systems continue to function as intended.

An operation and maintenance (O&M) plan is required for all systems. The O&M plan shall include a statement designating the entity which will be responsible for the operation and maintenance of the stormwater management system. Attached to the statement should be a defined maintenance program to ensure said system will function for the purpose for which it was intended, following either the frequency listed in table 1.8.1 or the frequency required by a permit. If the entity responsible for the O&M is not the entity for whom the engineering plans, specifications, and design analysis were submitted, then a letter should also be attached stating who the O&M entity will be and its agreement to conform to the defined O&M plan. Part B – BMP Criteria contains specific inspection items and other considerations to assist with the development of O&M plans for each BMP.

A report will be submitted to Pinellas County within 30 days of inspection, a system failure, or deviation from the permit for all BMPs. The results of all such inspections will be filed with the County using the form contained in Appendix F relating to “Operation and Maintenance Inspection Certification. Attached to the form should be a list of items that were inspected/addressed. Inspection frequency can be modified as set forth in a permit if required.

In addition to the regular inspections required by each BMP, the County may request that a qualified Florida-registered professional engineer is required to inspect the entire permitted stormwater treatmentsystem and submit a report describing the results of the inspection and recertifying that the stormwater treatment system is operating as designed and permitted according to the schedule set forth in Table 1.8.1.

Table 1.8.1 Stormwater Treatment System Recertification Frequency

<i>Type of Stormwater Treatment System</i>	<i>During the First Two Years of Operation</i>	<i>After First Two Years of Successful Operation</i>
Retention basins	Annually	Once every 5 years
Exfiltration trenches	Annually	Once every 24 months
Underground retention	Annually	Once every 24 months
Underground retention vault/chambers	Annually	Once every 24 months
Treatment Swales	Annually	Once every 5 years
Vegetated Natural Buffers	Annually	Once every 24 months
Pervious pavements	Annually	Once every 24 months
Green roof/cisterns	Annually	Once every 24 months
Wet detention basins	Annually	Once every 5 years
Managed aquatic plant systems	Annually	Once every 24 months
Stormwater harvesting	Annually	Once every 24 months
Depressed basins	Annually	Once every 5 years
Rain gardens	Annually	Once every 24 months
Alum injection	Annually	Once every 24 months

1.9. Additional Permitting Requirements to Protect Potable Water Supplies

Pursuant to Chapter 62-555,312(3), F.A.C., stormwater retention and detention systems are classified as moderate sanitary hazards with respect to public and private drinking water wells. Accordingly, stormwater treatment facilities will not be constructed within 50 feet of a public or private drinking water supply well.

1.10. Hazardous or Toxic Substances

Stormwater systems serving a land use or activity that produces or stores hazardous or toxic substances will be designed to prevent exposure of such materials to rainfall and runoff to ensure that stormwater does not become contaminated by such materials. The operating permits for such facilities should also be referenced as they may dictate the handling or management of stormwater runoff onsite. Such land uses may not be appropriate for certain BMPs such as retention basins to minimize introduction of such materials into the groundwater.

1.11. Co-mingling Off-site and On-site Stormwater Runoff

Specific load reductions required to meet the performance standards in [Section 3.1](#). apply only to the pollutant load generated from on-site runoff. If stormwater runoff from off-site areas is allowed to co-mingle with on-site runoff, the stormwater treatment system will be designed to achieve the performance standards in [Section 3.1](#). only for the pollutant load generated by on-site runoff. Attenuation will be required as described in [Chapter 2](#).

1.12. Off Site Compensating Treatment and Regional Treatment Facilities

Off-site compensating treatment may be used when on-site treatment is not sufficient to meet the required performance standards. This treatment may be provided through the construction of off-site treatment systems or through the use of regional treatment facilities. These facilities may be established by the private

sector, the public sector, or as a private-public partnership. Applicants relying on offsite compensating treatment or regional treatment facilities will be eligible for stormwater pollutant loadreduction credit to partially or fully meet their stormwater treatment requirements upon demonstration of thefollowing:

1. The off-site area must discharge stormwater to the same receiving water body as the proposed project, as determined by the County;
2. Modeling, loading calculations, or other data analysis demonstrate that the stormwater pollutant load reductions achieved by the combined onsite and off-site treatment systems meet the performance standards in Section 3.1; and
3. A perpetual off-site treatment easement over the area being used for treatment will be provided using an official form to allow perpetual access, operation, maintenance, and repair of the off-site treatment area by the permit holder. An equivalent legal instrument may be allowed if necessitated by site specific conditions.
4. Offsite treatment facilities must be constructed and fully operational.
5. The post development discharge rate cannot exceed the pre-development discharge rate up to and including the 25-year/24-hour storm event for open basins and up to and including the 100- year/24-hour storm event for closed basins.

1.13. Professional Certification Requirements

All copies of plans and drawings, together with supporting calculations and documentation submitted to the County must be signed, sealed, and dated by a licensed and/or registered professional, as required by Chapters [471](#) or [481](#), Florida Statutes, as applicable, when the design of the system requires the services of a registered professional.

1.14. Easement Requirements

In some cases, the County may require a drainage easement(s) as a condition of development. These easements generally authorize the County to maintain a drainage feature or facility to ensure proper inflow and outflow. Significantly, a drainage easement does *not* obligate the County to guarantee any particular standard of water quality. A drainage easement also typically does not obligate the County to maintain or replace infrastructure that the County does not install. Requisite drainage easements are determined on a case-by-case basis depending upon the impact of the development.

A drainage easement is often required over:

1. Land abutting a (i) 25-year floodway (or 25-year floodplain if no floodway is designated); (ii) 100-year floodway; or (iii) drainage channel of a major drainage system. The easement should be a minimum of 25-feet wide. Floodways and floodplains are depicted on Federal Emergency Management Agency (FEMA) maps and County stormwater and watershed management plans. "Major drainage system" is defined in Appendix G. of this Manual.
2. Wetlands. In lieu of a drainage easement, a conservation easement may be required. A conservation easement guarantees that the land will be maintained in essentially its natural state.
3. Canals and major waterways. The easement should extend at least 25-feet from each bank; however, all easements for canals and major waterways shall conform to recommendations of stormwater management plan or watershed management plan and they shall include sufficient width for the ultimate design canal top-of-bank width plus a minimum 25-foot level area on both sides of the proposed canal.

4. The following other drainage features or facilities, where such feature or facility accepts or conveys offsite public drainage.
 - a. Inflow and outfall control features and facilities. The easement should extend at least 20 feet from the feature or facility.
 - b. Swales. The easement should extend at least 10 feet from each bank.
 - c. Culvert pipes and structures. The easement should be a minimum of 15 feet wide.

Other notes:

- In some cases, an easement is required for drainage *and* additional County uses, e.g., utility. In such cases, the easement should be a minimum of 15 feet wide. The Public Works Director may require wider easements due to the depth and/or size of structures.
- Where a new drainage easement is required over an area that overlaps with an existing County easement or right-of-way, the existing County easement or right-of-way may normally be used to partially (and in rare cases fully) satisfy the requirements for the new drainage easement.
- Where a drainage feature or facility accepts or conveys private drainage from the surrounding development, a drainage easement should be granted to the community maintenance entity often the Homeowners' Association. If the maintenance entity becomes defunct, a new maintenance entity must be identified prior to the dissolution of the maintenance entity.
- All easements should be fully dimensioned on the final site plan and plat.

Chapter 2 – Stormwater Quantity and Flood Control Requirements

2.1. Stormwater Quantity Introduction

This Chapter provides the design criteria and methodologies for meeting the water quantity and conveyance requirements of the County's Land Development Codes. The criteria are intended to govern the design of new systems as well as the analysis and/or redesign of existing systems.

2.2. Design criteria.

2.2.1. Discharges to open watershed basins.

The following criteria are for design of stormwater management systems that discharge to an open watershed basin:

- The maximum allowable discharge for systems serving new developments and redevelopments will be limited to:
 - The historic discharge (as defined in the SWFWMD ERP handbook, volume 2, page 15), which is the peak rate at which runoff leaves a parcel of land under existing site conditions, for the 10-year / 24-hour and 25-year / 24-hour storm events, or
 - The allowable discharge per the last legally approved site plan at the time of application for the 10-year / 24-hour and the 25-year / 24-hour storm events.
- The rate of runoff leaving the site will not cause adverse off-site impacts.
- The Natural Resources Conservation Service (NRCS), formerly known as the Soil Conservation Service (SCS), type II Florida Modified 24-hour rainfall distribution with an antecedent moisture condition (AMC) II will be used unless the applicant demonstrates that a different rainfall distribution better characterizes the actual rainfall distribution on record.

2.2.2. Discharges to closed watershed basins.

The following criteria are for design of stormwater management systems that discharge to a closed watershed basin:

- For a project or portion of a project located within a closed watershed basin, the required retention volume will be the post-development runoff volume less the pre-development runoff volume computed using a 100-year / 24-hour storm with an antecedent moisture condition II (AMC II). The total post development volume leaving the site will be no more than the total pre-development volume leaving the site for the 100-year / 24-hour storm.
- The rate of runoff leaving the site will not cause adverse off-site impacts for design storms up to and including the 100-year / 24-hour event. Maintenance of pre-development off-site low flow may be required in hydrologically sensitive areas.

2.2.3. Discharges to tidal waters.

For stormwater management systems discharging to tidal waters (Gulf of Mexico, Boca Ciega Bay, or Tampa Bay), the peak discharge requirements of this Chapter are not required, provided that the rate of discharge does not cause adverse impacts, such as scouring, and the discharge is to an open tidal water body such as the Gulf of Mexico, Boca Ciega Bay, or Tampa Bay. Discharges to tributaries to these tidal water bodies that do not have any demonstrated hydraulic constraints will be considered on a case-by-case basis if no adverse hydraulic or water quality impacts are clearly demonstrated.

2.2.4. The State of Florida's Local Government Comprehensive Planning and Land Development Regulation Act requirements.

The State of Florida's Local Government Comprehensive Planning and Land Development Regulation Act requires local governments to develop comprehensive plans to guide and control future development. Plans must specify LOS for public facilities and services, including stormwater management.

2.2.5. Calculation of runoff rates.

Acceptable methods of computation of run-off are:

1. Sites one-acres or less. Rational method may be used to determine peak runoff rates for projects with total drainage areas of one acre or less.
2. Sites Greater than one acre. Other more precise methods acceptable to the county engineer will be employed for developments with drainage areas greater than one acre. See, for example, [U.S. Department of Agriculture Natural Resource Conservation Services Urban Hydrology for Small Watersheds \(TR-55\)](#).

2.2.6. General Requirements

1. All stormwater systems will be evaluated for the 100-year, 24-hour storm event to establish the minimum finished floor elevations of surrounding structures.
2. Where the lowest living Finished Floor Elevation (FFE) of a building is not governed by another code:
 - a. The minimum lowest living floor elevation specified on the site plan will be a minimum of 18 inches above the centerline (crown) of the adjacent roadway or 12 inches above the highest undisturbed adjacent grade (NAVD), whichever is greater.
3. All site plans will account for any street flooding and local stormwater flow from and onto adjacent properties and demonstrate that all buildings are protected from local stormwater flows. This requirement also applies to single family residential properties seeking a building permit.
4. All site plans will demonstrate appropriate grading to ensure positive drainage away from the buildings to the appropriate point of collection. This requirement also applies to single family residential properties seeking a building permit.
5. Hydraulics of curb and gutter construction:
 - a. The minimum grade for curb and gutter road construction will be 0.4 percent.
 - b. Length of curb run from any high point to a stormwater inlet will not exceed 400 feet.
6. Hydraulics of underground drainage and stormwater structures:
 - a. Underground flow through storm sewers, where employed, will conform to good, accepted engineering practice. Coefficients of friction suitable for the type of pipe or structure will be applied. Minimum pipe diameters will be 15 inches for side drains and 18 inches for cross drains, for swale drainage; 15-inch minimum pipe diameter for all closed (roadway and on-site) hydraulic design. Inverted siphons will not be accepted.
 - b. Stormwater structures such as bridges, box culverts, headwalls, dams, weirs, spillways, bulkheads and other structures will be designed hydraulically and structurally in accordance with good, accepted engineering practice. The effects on adjacent channels and structures will be considered. Foundations or other supports or anchoring methods will be adequate.

Erosion will be minimized by energy dissipators or other means of reducing flow velocity. Erosion control will be Florida Department of Transportation approved concrete ditch pavement per Index No. 281 or approved equal.

7. Culvert pipe:
 - a. Culvert pipe within right-of-way will be reinforced concrete pipe or an approved equivalent such as Contech A-2000. Easements for pipe outside of right-of-way will be large enough to permit access, maintenance, and protection.
 - b. Maximum length of culvert pipe between structures will not exceed 400 feet.
8. All backfill over any pipe (storm sewer, water line, sanitary sewer) that is to be installed under roadways or within the embankment, etc., of the roadway is to be compacted per department of transportation specifications, section 125.8.3, 1986 edition (or latest edition). This particular section specifies compaction to 100 percent of maximum density as determined by AASHTO T-99. This must be indicated on the plans.
9. Curb end transitions to meet department of transportation Index No. 300.
10. End walls will be made of 3,000 p.s.i. concrete per department of transportation Index No. 250 and will be used only outside the roadway recovery area.
11. Inlets:
 - a. *Curb type.* All inlets will be constructed of reinforced concrete. They will have a minimum inside area of ten square feet, with straight walls and suitable access through manhole covers. Inlets used also as junction boxes will be required to have formed inverts to one-half the pipe diameter. See Florida Department of Transportation Roadway and Traffic Design Standards Index Nos. 200 and 210 (latest edition). Bottomless inlets will not be allowed. County RC-3 and RC-4 inlets may be used in lieu of department of transportation Index No. 210. Curb inlets will not be placed within curb return radii.
 - b. *Ditch bottom type.* Will be constructed per subsection (11) a, above, with the exception that department of transportation Index No. 232 type D or greater will be used. A department of transportation index type F "modified" may be used and details obtained from the county land development/permitting division.
12. Manholes and junction boxes:
 - a. All manholes or junction boxes will be constructed of reinforced concrete. They will be a minimum of four feet inside diameter at the base with straight walls or corbelled a maximum of four inches in one foot, with a manhole rim cast in place for access.

Inverts are to be formed to a minimum of one-half the pipe diameter. Department of Transportation Index Nos. 200 and 201 will be used with a maximum corbel height of four feet and a vertical chimney height of no more than 18 inches including ring and cover.
 - b. The use of conflict boxes must be approved by the director. If approved, they must be constructed per subsections (11) a. or (12) a. of this section. The lowest portion of the conflict cannot be lower than the top one-third of the proposed storm sewer pipe.
13. Mitered end sections:
 - a. All culverts under roadways or driveways will have mitered end sections made of reinforced concrete meeting state department of transportation standards. Where shallow swales intersect deeper stormwater ditches, erosion control will be provided by use of culvert pipes,

concrete swales, mitered end section with spillways, or other suitable means. Cover material over culverts in swales will be stabilized, compacted and sodded to prevent erosion.

14. The design of valley crossings in streets will be submitted for approval. In no case will concrete valley gutters be less than 36 inches wide per Pinellas County Standard Details Detail Index 1315.
15. Curbs:
 - a. Vertical curb and gutter will conform to Department of Transportation Standard Plans Index No. 520-001 Type F.
 - b. Vertical curb without gutters will be constructed using 3,000 p.s.i. concrete and be per Department of Transportation Standard Plans Index No. 520-001 Type D and may be used on high side of road only.
 - c. All curbs will conform to the Americans with Disabilities Act where necessary, e.g., sidewalks at intersections.
 - d. Curb and gutter Type A and header curb will be 24 inches wide with a minimum thickness of six inches at the center, with a three-inch rise to the back of the curb and a one-inch rise to the pavement edge, as shown Pinellas County Standard Details Detail Index 1305, with 3,000 p.s.i. concrete used throughout.

2.3. Portion of Water Quality Treatment Volume that can Count towards Water Quantity Storage Requirements

Subject to the criteria below, a portion of the runoff volume captured for water quality treatment per Chapter 3 may also be counted toward the volume required for water quantity storage per Chapter 2.

2.3.1. Timelines for Wet Detention Systems

Due to the detention time required for wet detention systems, only that volume which drains below the overflow elevation within 36 hours may be counted as part of the volume required for water quantity storage.

2.3.2. On-line/Off-line Retention Systems

For on-line and off-line retention systems, only that volume which can again be available within 36 hours may be counted as part of the volume required for water quantity storage.

2.3.3. Exfiltration Maintenance and Life Expectancy

Due to the maintenance requirements and life expectancy of exfiltration systems, both the storage volume of the perforated pipe and 30% of the stone aggregate volume, or 80% of the measured testing lab values for the selected aggregate(s), above the seasonal high groundwater table may be counted as part of the volume required for water quantity storage.

Chapter 3– Stormwater Quality Permitting Requirements

3.1. Introduction & Performance Standards

This Chapter provides the performance standards for meeting the water quality requirements of the County's Land Development Codes. The criteria are intended to govern the design of new systems as well as the analysis and/or redesign of existing systems.

3.1.1. General Performance Standards

Except for exempt projects meeting the criteria in Subsection 1.5.1, the stormwater treatment system will be designed to meet the pollutant removal of the following performance standards:

1. Reduce the post-development annual average stormwater total nitrogen load by at least 55% and the annual average stormwater total phosphorus load by at least 80%; and,
2. Reduce the post-development annual average stormwater total nitrogen and phosphorus loads by 10% or more of the undeveloped or current annual discharge loads.

For assistance with stormwater pollutant loading and treatment efficiency calculations, please see Part C-[Design Guide, Calculating Stormwater Pollutant Loading](#)



PINELLAS COUNTY

STORMWATER MANUAL

PART B - BEST MANAGEMENT PRACTICE (BMP) CRITERIA





Chapter 4 – Best Management Practice Criteria

4.0. Catalog of Stormwater Best Management Practices (BMPs)

4.0.1. Introduction to BMPs

This section of the Manual sets forth county-specific technical criteria for the design, construction, operation, and maintenance of Best Management Practices or BMPs. These systems can be used individually or in series - as part of a so-called BMP Treatment Train - to achieve the required minimum levels of pollutant load reduction.

Below is table 4.0.1 with quick links to each type of green infrastructure BMP, along with supplemental links to external resources for additional information.

Example Project:	Type of BMP:	Stormwater Manual Section:	Stormwater Manual Page Number:	Other Information:
 <p>PK Ave. Auburndale, FL</p>	Bioswales/Treatment Swales/Green Gutters	4.4	31	<p>Developer Benefits:</p> <ul style="list-style-type: none"> • Reduces Upfront Site Infrastructure Costs • Contributes to Site Appeal and Aesthetics • Assists in Compliance with Stormwater Management Requirements for Quality and Quantity. • Helps with Green Buffer Site Requirements • Less infrastructure conveyance elements to maintain <p>Public Benefits:</p> <ul style="list-style-type: none"> • Reduces dependence on public regional stormwater systems • Reduces community heat island effect • Improves water quality of runoff from the site • Enhances neighborhood aesthetics. • Contributes to Community Resilience • Increases groundwater recharge <p>https://www.epa.gov/green-infrastructure/what-green-infrastructure</p>
 <p>US 1 Islamorada, FL</p>	Vegetated Filter Strips	4.5	39	<p>Developer Benefits:</p> <ul style="list-style-type: none"> • Reduces Upfront Site Infrastructure Costs • Helps with Open Space Requirements • Reduces Overall Site Impervious Area • Reduces Directly Connected Impervious Area (DCIA) • Reduces the needed treatment and attenuation of runoff from the site <p>Public Benefits:</p> <ul style="list-style-type: none"> • Enhances neighborhood aesthetics and open space • Reduces community heat island effect • Improves water quality of runoff from the site • Contributes to Community Resilience • Reduces burden on public regional stormwater systems • Increases groundwater recharge <p>https://www.epa.gov/green-infrastructure/what-green-infrastructure</p>

 <p>Henrietta Ave./Jean St.Largo, FL</p>	<p>Pervious Pavement</p>	<p>4.6</p>	<p>44</p>	<p>Developer Benefits:</p> <ul style="list-style-type: none"> • Reduces Overall Site Impervious Area • Requires less On-Site Retention/Detention Area • Assists in compliance with onsite parking regulations • Reduces the needed treatment and attenuation of runoff from the site <p>Public Benefits:</p> <ul style="list-style-type: none"> • Improves water quality of runoff from the site • Contributes to Community Resilience • Reduces burden on public regional stormwater systems • Increases groundwater recharge <p>https://www.epa.gov/soakuptherain/soak-rain-permeable-pavement</p>
 <p>Escambia County Office Pensacola, FL</p>	<p>Green Roofs</p>	<p>4.7</p>	<p>61</p>	<p>Developer Benefits:</p> <ul style="list-style-type: none"> • Reduces Cooling and Heating Costs • Requires less On-Site Retention/Detention Area • Improves Building Amenities • Reduces the needed treatment and attenuation of runoff from the site especially when combined with rain barrels <p>Public Benefits:</p> <ul style="list-style-type: none"> • Reduces the volume of runoff from the site especially when combined with rain barrels • Reduces the heat island effect • Increases community green space • Improves Community Resiliency <p>https://greenroofs.org/about-green-roofs/</p>
 <p>Eagle Lakes Sub Stormwater Reuse Flagler County, FL</p>	<p>Stormwater Harvesting Systems</p>	<p>4.9</p>	<p>78</p>	<p>Developer Benefits:</p> <ul style="list-style-type: none"> • Requires less On-Site Retention/Detention Area • Reduces potable water use for irrigation • Reduces infrastructure maintenance costs <p>Public Benefits:</p> <ul style="list-style-type: none"> • Reduces the volume of runoff from the site • Reduces use of potable water for irrigation • Reduces runoff from the site into the public system • Improves Community Resiliency <p>http://stormwater.ucf.edu/fileRepository/docs/conferences/9thstormwaterCD/documents/StormwaterReuse_PPT.pdf</p> <p>http://stormwater.ucf.edu/wp-content/uploads/2014/09/FinalReportFDOTMay2013.pdf</p>
 <p>Lakefront Park Kissimmee, FL</p>	<p>Up-Flow Filter Systems; Nutrient Baffle Box</p>	<p>4.10</p>	<p>87</p>	<p>Developer Benefits:</p> <ul style="list-style-type: none"> • Reduces up front site infrastructure costs • Assists in compliance with stormwater management requirements for quality and quantity • Reduces footprint needed to achieve treatment requirements • Less subterranean conveyance elements to maintain

				<p>Public Benefits:</p> <ul style="list-style-type: none"> • Reduces dependence on public regional stormwater systems • Improves water quality of runoff from the site, including trash removal <p>http://stormwater.ucf.edu/wp-content/uploads/2014/09/CUFSWaterSoilAirPublicaton.pdf</p>
 <p>Lakefront Park Kissimmee, FL</p>	<p>Biofiltration Tree/Planter Boxes</p>	<p>4.12</p>	<p>100</p>	<p>Developer Benefits:</p> <ul style="list-style-type: none"> • Reduces Upfront Site Infrastructure Costs • Contributes to Site Appeal and Aesthetics • Assists in Compliance with Stormwater Management Requirements for Quality and Quantity. • Helps with Green Buffer Requirements • Less subterranean conveyance elements to maintain <p>Public Benefits:</p> <ul style="list-style-type: none"> • Reduces dependence on public regional stormwater systems • Reduces community heat island effect • Increases shade for pedestrians • Improves water quality of runoff from the site • Enhances neighborhood aesthetics. • Contributes to Community Resilience • Increases groundwater recharge <p>https://www.epa.gov/green-infrastructure/what-green-infrastructure#planterboxes</p>
 <p>Anderson Park Pinellas County, FL</p>	<p>Rain Gardens/Bioretention Cells</p>	<p>4.13</p>	<p>118</p>	<p>Developer Benefits:</p> <ul style="list-style-type: none"> • Reduces Upfront Site Infrastructure Costs • Contributes to Site Appeal and Aesthetics • Assists in Compliance with Stormwater Management Requirements • Helps with Green Buffer Site Requirements • Less infrastructure conveyance elements to maintain <p>Public Benefits:</p> <ul style="list-style-type: none"> • Reduces dependence on public regional stormwater systems • Reduces community heat island effect • Improves water quality of runoff from the site • Enhances neighborhood aesthetics. • Contributes to Community Resilience • Increases groundwater recharge <p>https://www.epa.gov/green-infrastructure/what-green-infrastructure</p>



 <p>Florida House Institute Sarasota, FL</p>	<p>Rainwater Harvesting</p>	<p>4.14</p>	<p>124</p>	<p>Developer Benefits:</p> <ul style="list-style-type: none"> • Improves Building Amenities • Reduces potable water use and operating expenses <p>Public Benefits:</p> <ul style="list-style-type: none"> • Reduces the volume of runoff from the site • Reduces dependency on potable water • Improves Community Resiliency <p>https://www.epa.gov/green-infrastructure/what-green-infrastructure</p>
 <p>Ormond Beach, FL</p>	<p>Rainfall Interceptor Trees</p>	<p>4.15</p>	<p>132</p>	<p>Developer Benefits:</p> <ul style="list-style-type: none"> • Reduces Upfront Site Infrastructure Costs • Contributes to Site Appeal and Aesthetics • Assists in Compliance with Stormwater Management Requirements for Quality and Quantity. • Helps with Green Buffer Requirements • Less subterranean conveyance elements to maintain <p>Public Benefits:</p> <ul style="list-style-type: none"> • Reduces dependence on public regional stormwater systems • Reduces community heat island effect • Increases shade for pedestrians • Improves water quality of runoff from the site • Enhances neighborhood aesthetics. • Contributes to Community Resilience • Increases groundwater recharge <p>https://www.itreetools.org/</p>
 <p>Living Shoreline MacDill Air Force Base Tampa, FL</p>	<p>Living Shorelines</p>	<p>N/A</p>	<p>N/A</p>	<p>Developer Benefits:</p> <ul style="list-style-type: none"> • Improves Site Aesthetics • Mostly less expensive than conventional seawalls <p>Public Benefits:</p> <ul style="list-style-type: none"> • Improves biodiversity • Improves water quality benefits • Community Asset • Reduces erosion and improves resiliency <p>https://www.fisheries.noaa.gov/insight/understanding-living-shorelines</p>

Table 4.0.1 – Chart of GI BMPs with benefits and resources for more information

To achieve the level of nutrient treatment required for the protection and restoration of Pinellas County’s surface and ground waters, greater emphasis must be placed on non-structural BMPs, the Site Planning BMPs in [Section 6.7](#), and the Source Control BMPs in [Section 6.8](#). These non-structural BMPs, which are typically focused on pollution control at the source through operational management practices, need to be the first “cars” in the BMP Treatment Train. Non-structural BMPs, by definition, are also customarily less expensive to implement, due to the absence of capital expenses associated with structural construction and operational maintenance. When applied early in the design process, these low impact

development techniques can reduce stormwater volume and pollutants generated from development sites. People are increasingly becoming educated consumers and choosing to purchase things they consider to be green, renewable, or sustainable. Companies have caught on to demand sustainable goods and are leveraging environmentally conscious decisions to market their products and services and improve their “triple bottomline”. Green infrastructure can also be a valuable asset to site developers and property owners from an economic perspective. When green infrastructure BMPs are employed, many benefits (beyond improved environmental quality and stormwater management) can be realized, including:

- Increased development intensity
- Increased retail sales
- Increased rents and property values
- Increased occupancy rates/sales
- Faster sales
- Reduced infrastructure costs
- Stormwater fee credits
- Increase opportunity for grants and public-private partnerships
- Potential for tax credits
- Higher marketability for the development (by 10-15%)
- Reduced energy use
- Reduced water bills
- Increased mental health of residents or office employees in the case of a business complex
- Reduced crime
- Reduced maintenance/life-cycle costs
- Increased attention and visibility + positive media attention
- Recognition by “eco labels” such as LEED, Sustainable Sites Initiative, etc.
- Listing on local green infrastructure websites as a project example or case study

Resource for further details: <https://www.nrdc.org/resources/green-edge-how-commercial-property-investment-green-infrastructure-creates-value>

Treatment Process/ Function	SCM Options	What is Removed?	How Does It Happen?
Flotation	Skimmers, Oil-Water Separators, and Density Separators	Trash, oil and other hydrocarbons	Substances lighter than water are removed with units specifically designed for this purpose.
Settling/ Sedimentation	Bioretention, wetlands, wet/dry ponds, tree boxes, and cisterns	Suspended solids, metals, particulate phosphorus, and organics	Suspended particles settle by gravity, along with pollutants adhered to them. Forebays must capture and facilitate periodic removal of sediment. Avoid re-suspension of sediment.
Filtration	Sand/gravel filters, natural/amended soil, green roofs, infiltration tanks, and horizontal wells	Suspended solids, metals, phosphorus, and organics	Stormwater passes through a porous material, mechanically removing anything larger than the pore openings.
Sorption	Any BMP employing infiltration thru soils or other media, especially organic material or clay	Dissolved nutrients, metals, and bacteria	Contaminants adhere to irregularities in the surface of vegetation, to clay particles in soil, or are attached to other molecules by chemical bonds
Biological Removal	Bioretention, enhanced ponds, and floating islands	Nitrogen, phosphorus, and organic molecules	Microorganisms and plants take in nutrients needed for their cell growth and break apart large organic molecules.

Figure 4.0.1: List of stormwater control measures (SCMs), or BMPs, and their associated functions (UF IFAS Extension)

Low impact development BMPs that are eligible for specific stormwater nutrient load reduction credits include several of the Site Planning and Source Control BMPs discussed in [Chapter 6](#). These include Natural Area Conservation, Minimize Total Impervious Area, Minimize DCIA, and [Florida-friendly™ landscaping](#) and fertilizers. Additional green infrastructure BMPs for which nutrient loadreduction credits can be obtained include:

- Treatment swales (Section 4.4)
- Vegetated natural buffers (Section 4.5)
- Pervious pavements (Section 4.6)
- Green roofs with cisterns (Section 4.7)
- Stormwater harvesting (Section 4.9)
- Rain gardens (Section 4.13)
- Rainwater harvesting systems (Section 4.14)
- Rainfall interceptor trees (Section 4.15)

Detailed design criteria along with construction, inspection, operation, and maintenance guidelines are set forth for the following structural BMPs included in this Chapter:

- Retention basins (Section 4.1)
- Exfiltration trenches (Section 4.2)
- Underground storage and retention systems (Section 4.3)
- Treatment swales (Section 4.4)
- Vegetated natural buffers (Section 4.5)
- Pervious pavement systems (Section 4.6)
- Green roof/cistern systems (Section 4.7)
- Wet detention systems (Section 4.8)
- Stormwater harvesting systems (Section 4.9)
- Up-Flow filter systems (Section 4.10)
- Managed Aquatic Plant Systems (MAPS) (Section 4.11)
- Biofiltration Systems with Biosorption Activated Media (BAM)
- Rain gardens (Section 4.13)
- Rainwater harvesting systems (Section 4.14)
- Interceptor Trees (Section 4.15)

Each section in Chapter 4 begins with a summary table that highlights the most critical information for the specific BMP covered in that section. The following information is included in these summary tables:

- Advantages/Benefits
- Disadvantages/Limitation

- Volume reduction potential
- Pollutant removal potential
- Key design considerations
- Key construction and maintenance considerations

Criteria provided in Chapter 4 are considered minimum standards for the design of stormwater treatment systems in Pinellas County. The stormwater treatment system (the treatment train) should be designed so that the entire system meets minimum stormwater control requirements. It is important that users of this manual consult with SWFWMD Environmental Resource Permitting criteria and the County's guidance documents on land development and stormwater management, including the [County Comprehensive Plan](#), [Land Development Regulations and Zoning Code](#), for any variations to these criteria or additional standards that must be followed.

Below are some general design considerations applicable to all BMPs:

- Design with maintenance in mind, such as ensuring adequate access to the BMP for performing inspections and maintenance. Consider adding a pre-treatment inlet or forebay to simplify sediment removal and observation wells/clean-outs for ease of inspections and maintenance activities.
- Select non-floating, [sustainable \(Florida Friendly™\) mulch](#)
- Consider leaf litter from trees with regards to maintenance of the BMP – select trees that have less leaf litter or place them farther away from the water's edge, grates, control structures, pipes, etc.
- Certain plants will perform better in periodically inundated/dry conditions such as those in a bioswale or rain garden. Select low maintenance plants appropriate for the specific location and planting zone – see section 4.0.2 for lists of suggested plants.

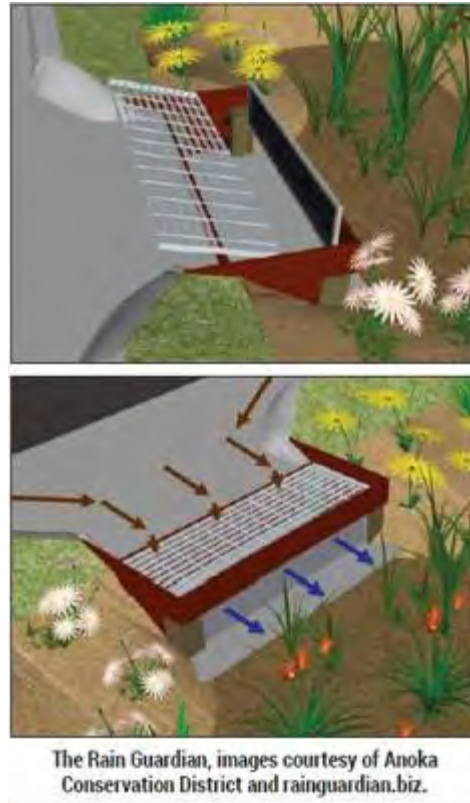

Figure 4.0.2: Rain Guardian sediment trap

The BMPs in this Manual provide a wide range of average annual TN and TP load reductions. In general, retention BMPs provide the greatest level of pollutant load reduction because they reduce the annual stormwater volume discharged off-site. The treatment effectiveness of retention BMPs is directly proportional to the percentage of the annual stormwater volume that is captured and retained on-site. Tables 6.10.4 and 6.10.5 in Part C-Design Guide provide the range of pollutant load reductions associated with retaining a specific volume of stormwater under varying conditions of the percent DCIA and the non-DCIA Curve Number. For example, Table 6.10.4 shows the stormwater volume needed to achieve 80% average annual load reduction varies from 0.23 inches to 1.59 inches. The effectiveness of wet detention systems varies depending on the average annual residence time as shown in Figures 6.10.3 (TP) and 6.10.4 (TN). In general, a wet detention system can achieve a 30% to 43% reduction in TN and a 45% to 85% reduction in TP. To increase the effectiveness of a wet detention system, one can add managed aquatic plants (10% to 20% removal) or a stormwater harvesting system that takes water from the wet detention system and uses it for non-potable purposes, thereby reducing the stormwater volume discharged by the wet detention system. Additionally, an upflow filter can be used at the discharge of a wet detention system to improve nutrient load reductions.

4.0.2. Integrating Landscaping and Green Infrastructure elements

[Chapter 138 Article X Division 3](#) of the County's Development Code sets forth the Landscaping requirements for non-residential and multifamily new development and redevelopment projects. Specifically, the Purpose and Intent section encourages the integration of green infrastructure BMPs into a site's landscaping, several subsections provide guidance on the acceptable application of green infrastructure options. For the purposes of this Section, the following BMPs within the Manual are designated as green infrastructure BMPs:

- Treatment swales
- Vegetated natural buffers
- Stormwater harvesting systems
- Biofiltration systems
- Rain gardens
- Rainfall harvesting systems
- Rainfall interceptor trees

[Chapter 138 Article X Division 3](#) also sets forth requirements for the landscaping of green infrastructure BMPs. These include the Planting Zones within the BMPs and the recommended plants. Once the plant zones are identified (Zone A or B) for a BMP, the plants may be selected. Plant selection should take into account the following factors;

1. Tolerant of varied moisture conditions (wet and dry),
2. Tolerant of varied soil types and growing conditions,
3. Available in Central Florida plant nurseries,
4. Low maintenance requirements,
5. Are not on the [Florida Exotic Pest Plant Council invasive plant list](#),
6. Do not have aggressive/invasive root systems, and
7. Exhibit an attractive appearance.

When selecting plants, additional site-specific information, such as tolerance to high and low temperatures, coastal conditions, and prevailing winds should be considered. In addition, project-specific aspects of the design, for example, right-of-way vegetation height limits, may further influence selection.

Plant selection and placement are critical to a successful project, and when done correctly, results in an aesthetically pleasing finished product that easy to maintain and has great longevity. Each section below includes a list of some suggested plants. For more options, see the [filterable list of suggested, native plants and trees](#), including aquatic plants. The list defines attributes for each plant such as light/water requirement, salt/flood tolerance, and physical characteristics, maintenance considerations. Even more, options are available by viewing the [Florida Friendly™ plant selection guide](#).

4.1. Retention Basin Design Criteria

4.1.1. Description

A “retention basin” is a depressional area within the landscape that is designed to store and retain a defined quantity of runoff, allowing it to percolate through permeable soils into the shallow groundwater. This section discusses the requirements for retention systems, historically referred to as “dry retention basins”, or natural depressional areas, often integrated into a site’s landscaping, where the bottom is typically flat, and turf (natural turf grass, no synthetic turf), natural ground covers, or other appropriate vegetative or other methods are used to promote infiltration and stabilize the basin bottom and slopes (see Figure 4.1.1).

The major difference between retention basins and detention basins is that retention basins are customarily designed to contain the total runoff volume from a specific storm – usually the 50-year or 100-year design

storms. The only method for the retention basin to recover its storage capacity is through infiltration. This has the added benefit of eliminating any pollutants carried by stormwater from leaving the site.

Soil permeability and water table conditions are essential to the successful use of retention basins so they can percolate the required treatment runoff volume within a specified time following a storm event. After drawdown has been completed, the basin does not hold any water, thus the system is normally “dry.” Unlike detention basins, the treatment volume for retention systems is not discharged to surface waters.

Retention basins provide numerous benefits, including reducing stormwater volume leaving a site, which also reduces the average annual pollutant loading discharged from the system to the County system or other receiving water bodies. Additionally, many stormwater pollutants such as suspended solids, oxygen demanding materials, heavy metals, bacteria, some varieties of pesticides, and nutrients are removed as runoff percolates through the soil profile.

RETENTION BASIN SUMMARY

Advantages/Benefits	Reduces stormwater volume, peak discharge rate, pollutant loadings, and heat island effect. Provides groundwater recharge and enhanced site aesthetics.
Disadvantages/Limitations	Can require a large footprint. Do not construct within 50 feet of a public or private potable water supply well or within 15 feet of an onsite wastewater disposal and treatment system. The site must have appropriate soil and SHGWT conditions for infiltration. Not appropriate on sites with potentially hazardous or toxic materials.
Volume Reduction Potential	High
Pollutant Removal Potential	High for all pollutants
Key design considerations	SHGWT at least 2 feet below bottom; recovery of treatment volume within 24 to 72 hours; sides and bottoms must be stabilized with vegetation or other approved materials
Key construction and maintenance considerations	Minimize soil compaction and sedimentation during construction; ensure design infiltration is met after construction; inspect during the wet season to see if water is ponding and not infiltrating properly; restore infiltration capacity as needed to meet permit requirements

To accomplish the desired level of pollutant load reduction, retention basins will be designed in accordance with the following design and performance criteria.



4.1.2. Required Treatment Level and Associated Treatment Volume

The Required Treatment Volume (RTV) necessary to achieve the needed treatment efficiency will be routed to the retention basin and percolated into the ground. The required nutrient load reduction is set forth in the performance standards in [Section 3.1.1](#) of this Manual. In general, the Required Treatment Volume (RTV) is always less than the Required Retention Volume (RRV), which is the runoff volume associated with the design storm required by the County. Thus, if a retention basin is designed to meet the RRV, it usually automatically meets any other associated RTV requirements.

Treatment volumes to achieve the necessary efficiencies will be determined based on the percentage of directly connected impervious area (DCIA) and the weighted curve number for non-DCIA areas as set forth in [Tables 6.10.4 and 6.10.5](#).

It is worth noting that the integration of Green Infrastructure elements into the site design could have the two-fold benefit of reducing the percentage of DCIA, while simultaneously attenuating/treating runoff from the site and, as such, reducing the volume of surface runoff and pollutant loading to the retention basin, and as such, causing the basin itself to be smaller and taking less space on site.

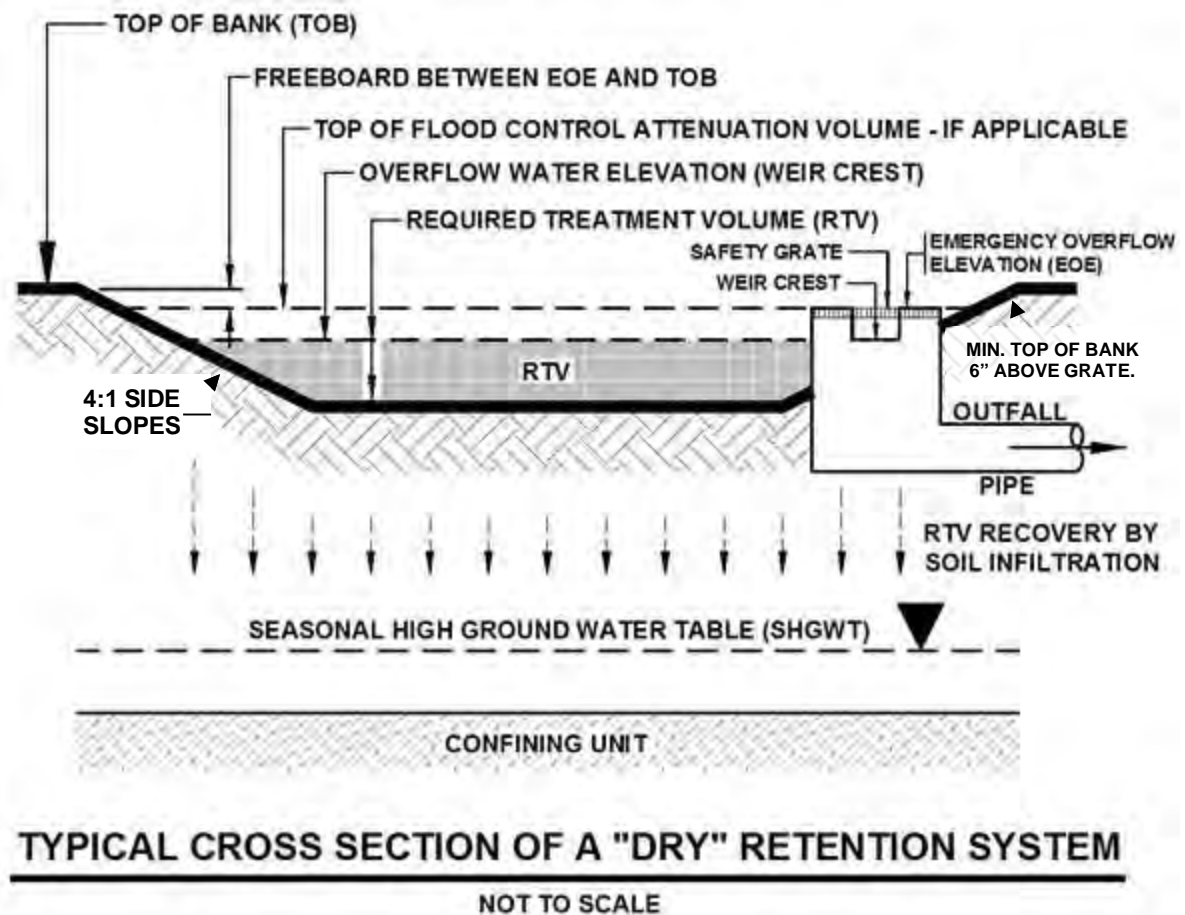

Figure 4.1.1. Typical Cross-section of "Dry" Retention Basin

4.1.3. Calculating Load Reduction Efficiency for a Given Retention Volume

Use **Table 6.10.4 in Part C-Design Guide** to determine the treatment volume needed to achieve the presumptive 80% pollutant load reduction. If retention basins are being used in a BMP treatment train to achieve part of the required pollutant load reduction use **Table 6.10.5** to determine the percent reduction associated with various treatment volumes. Also, use **Table 6.10.5** to determine the treatment volume associated with the required nutrient load reduction to achieve the performance standard of reducing nutrient loads by at least 10% from current discharges.

4.1.4. Design Criteria

- (a) The retention basin must have the capacity to retain the required treatment volume without a discharge and without considering soil storage.
- (b) The retention basin must recover the required treatment volume of stormwater within 72 hours, with a safety factor of two, assuming average Antecedent Runoff Condition (ARC 2). Vegetated systems

need to recover the required treatment volume within 24 to 36 hours to prevent damage to vegetation. A recovery analysis is required that accounts for the mounding of ground water beneath the retention basin. Requirements related to safety factors, mounding analysis and supporting soil testing is provided in Appendix A of this Manual.

- (c) The seasonal high ground water table will be at least two feet beneath the bottom of the retention basin unless the applicant demonstrates, based on plans, test results, calculations or other information, that an alternative design is appropriate for the specific site conditions.
- (d) The retention basin sides and bottom will be stabilized with permanent vegetative cover, some other pervious material, or other methods acceptable to the County that will prevent erosion and sedimentation. Vegetation will not be muck grown sod or synthetic material of any kind.
- (e) Retention basins will not be constructed within 50 feet of a public or private potable water supply well or within 15 feet of an onsite wastewater disposal and treatment system.
- (f) The top bank of a retention basin will not be within 5-ft of the right-of-way.

4.1.5. Required Site Information

Successful design of a retention system depends greatly upon knowing conditions at the site, especially information about the soil, geology, and water table conditions. Specific data and analyses required for the design of a retention system including details related to safety factors, mounding analyses, and required soil testing are set forth in APPENDIX A of this Manual.

4.1.6. Retention Basin Construction

Retention basin construction procedures and the overall sequence of site construction are two key factors that can control the effectiveness of retention basins. The applicant must demonstrate that the design infiltration rate will be met after construction by minimizing soil compaction during construction and minimizing the amount of sediment deposited into the retention basin.

Because stormwater management systems are required to be constructed during the initial phases of site development, retention basins are often exposed to poor quality surface runoff. Stormwater runoff during construction contains considerable amounts of suspended solids, organics, clays, silts, trash and other undesirable materials. For example, the subgrade stabilization material used during the construction of roadways and pavement areas typically consists of clayey sand or soil cement. If a storm occurs when these materials are exposed (prior to placement of the roadway wearing surface), considerable amounts of these materials end up in the stormwater conveyance system and the retention basin, hindering infiltration through the system. Another source of fine material generated during construction is disturbed surface soil that can release large quantities of organics and other fine particles. Fine particles of clay, silt, and organics at the bottom of a retention basin also create a poor infiltrating surface.

The following construction procedures are required to avoid degradation of retention basin infiltration capacity due to construction practices:

- (a) The location and dimensions of the retention basin will be verified onsite prior to its construction. All design requirements including retention basin dimensions and distances to foundations, septic systems, wells, etc., need to be verified.
- (b) The location of retention basins will be clearly marked at the site to prevent unnecessary vehicular traffic across the area causing soil compaction.

- (c) Initially construct the retention basin by excavating the basin bottom and sides to approximately 12 inches above final design grades.
- (d) Excavation will be done by lightweight equipment to minimize soil compaction. Tracked, cleated equipment does less soil compaction than equipment with tires.
- (e) After the watershed area contributing to the basin has been fully stabilized, the interior side slopes and basin bottom will be excavated to final design specifications. The excess soil and undesirable material must be carefully excavated and removed from the basin so that all accumulated silts, clays, organics, and other fine sediment material has been removed from the pond area. The excavated material will be disposed of in a manner that assures it will not re-enter the retention basin.
- (f) Once the basin has been excavated to final grade, the entire basin bottom must be deep raked and loosened for optimal infiltration. The depth to be raked is dependent on the type, weight and contact pressure of the construction equipment used during the bulk excavation of the basin.

An applicant may propose alternative construction procedures to assure that the design infiltration rate of the constructed and stabilized retention basin is met.

4.1.7. Inspections, Operation and Maintenance

Maintenance issues associated with retention basins are related to clogging of the porous soils, which reduces or prevents infiltration thereby slowing recovery of the stormwater treatment volume and often resulting in standing water. Sedimentation can cause clogging and resulting sealing of the bottom or side slope soils. It can also occur from excessive loading of oils and greases or from excessive algal or microorganism growth. Standing water within a retention basin can also result from an elevated high water table or from ground water mounding, both of which can present long-term operational issues that may require redesign of the system.

To determine if an infiltration system is properly functioning or whether it needs maintenance requires that an inspection be done within 72 hours after a storm. The inspection should determine if the retention basin is recovering its storage volume within its permitted time frames, generally 24 to 72 hours after a storm. If this is not occurring and there is standing water, then the cause must be determined, and actions undertaken beginning with those specified in the system’s Operation and Maintenance Plan.

(a) Inspection Items:

(1)	Inspect basin for storage volume recovery within the permitted time, generally less than 72 hours. Failure to percolate the required treatment volumes indicates reduction of the infiltration rate and a need to restore system permeability.
(2)	Inspect and monitor sediment accumulation on the basin bottom or inflow to prevent clogging of the retention basin or the inflow pipes.
(3)	Inspect vegetation of bottom and side slopes to assure it is healthy, maintaining coverage, and that no erosion is occurring within the retention basin.
(4)	Inspect inflow and outflow structures, trash racks, and other system components for accumulation of debris and trash that would cause clogging and adversely impact operation of the retention basin.
(5)	Inspect the retention basin for potential mosquito breeding areas such as where standing water occurs after 72 hours or where cattails, other invasive or nuisance vegetation becomes established.

(b) Maintenance Activities As-Needed to Prolong Service:

(1)	If needed, restore the infiltration capacity of the retention basin so that it meets the permitted recovery time for the required treatment volume.
(2)	Remove accumulated sediment from retention basin bottom and inflow and outflow pipes and dispose of properly. Please note that stormwater sediment disposal may be regulated under Chapter 62-701, F.A.C. (Sediment removal should be done when the system is dry and when the sediments are cracking).
(3)	Remove trash and debris inflow and outflow structures, trash racks, and other system components to prevent clogging or impeding flow.
(4)	Maintain healthy vegetative cover to prevent erosion in the basin bottom, side slopes or around inflow and outflow structures. Vegetation roots also help to maintain soil permeability. Grass needs to be mowed and grass clippings removed from the basin to reduce internal nutrient loadings.
(5)	Eliminate mosquito breeding habitats.
(6)	Assure that the contributing watershed area is stabilized and not a source of sediments.

4.2. Exfiltration Trench Design Criteria

4.2.1. Description

An exfiltration trench is a subsurface retention system consisting of a conduit such as perforated pipe surrounded by natural or artificial aggregate which temporarily stores and infiltrates stormwater runoff (Figure 4.2.1). Stormwater passes through the perforated pipe and infiltrates through the trench walls and bottom into the shallow ground water aquifer. The perforated pipe increases the storage available in the trench and helps promote infiltration by making delivery of the runoff more effective and evenly distributed over the length of the system.

Soil permeability and water table conditions must be such that the trench system can percolate the required stormwater runoff treatment volume within a specified time following a storm event. The trench system is returned to a normally “dry” condition when drawdown of the treatment volume is completed. Similar to retention basins, the treatment volume in exfiltration trench systems is not discharged to surface waters.

Like other types of retention systems, exfiltration trenches provide reduction of stormwater volume that reduces pollutant loads. Additionally, substantial amounts of suspended solids, oxygen demanding materials, heavy metals, bacteria, some varieties of pesticides and nutrients such as phosphorus may be removed as runoff percolates through the soil profile.

The operational life of an exfiltration trench depends on site conditions, system design, use of pretreatment BMPs, and maintenance. Sediment accumulation and clogging by fines can reduce the life of an exfiltration trench. Total replacement of the trench may be the only possible means of restoring the treatment capacity and recovery of the system. Periodic replacement of the trench should be considered routine operational maintenance when selecting this management practice. As such, exfiltration trenches must be located where replacement can readily occur. They will not be placed within 10 feet of a building and must be designed with adequate accessibility for maintenance or trench replacement.

EXFILTRATION TRENCH SUMMARY

Advantages/Benefits	Reduces stormwater volume, peak discharge rate, pollutant loadings, and heat island effect. Provides ground water recharge and enhanced site development potential.
Disadvantages/Limitations	Only permitted for projects to be operated by entities with single owners or with full-time maintenance staff. Do not construct within 50 feet of a public or private potable water supply well or within 15 feet of an onsite wastewater disposal and treatment system. Site must have appropriate soil and SHGWT conditions for infiltration. Not appropriate on sites with potential hazardous or toxic materials.
Volume Reduction Potential	High
Pollutant Removal Potential	High for all pollutants
Key design considerations	SHGWT at least 2 feet below bottom; recovery of treatment volume within 24 – 72 hours; pretreatment via swales or catch basins essential to prevent litter, trash, leaves, and other debris from entering exfiltration trench.
Key construction and maintenance considerations	Minimize soil compaction and sedimentation during construction; block Inflows to the trench until the contributing watershed area is stabilized. Ensure design infiltration is met after construction; inspect during wet season to see if water is ponding and not infiltrating properly; restore infiltration capacity as needed to meet permit requirements.

4.2.2. Required Level of Treatment and Associated Treatment Volume

The Required Treatment Volume (RTV) necessary to achieve the needed treatment efficiency will be routed to the exfiltration trench and percolated into the ground. The required nutrient load reduction is set forth in the performance standards in **Section 3.1.1.** of this Manual.

Treatment volumes to achieve the necessary efficiencies will be determined based on the percentage of directly connected impervious area (DCIA) and the weighted curve number for non-DCIA areas as set forth in Table 6.10.4 and Table 6.10.5. It is worth noting that the integration of Green Infrastructure elements into the site design could have the two-fold benefit of reducing the percentage of DCIA, while simultaneously attenuating/treating runoff from the site and, as such, reducing volume of surface runoff and pollutant loading to the exfiltration system.

Exfiltration trenches must be designed to have the capacity to retain the required treatment volume without discharging to surface waters.

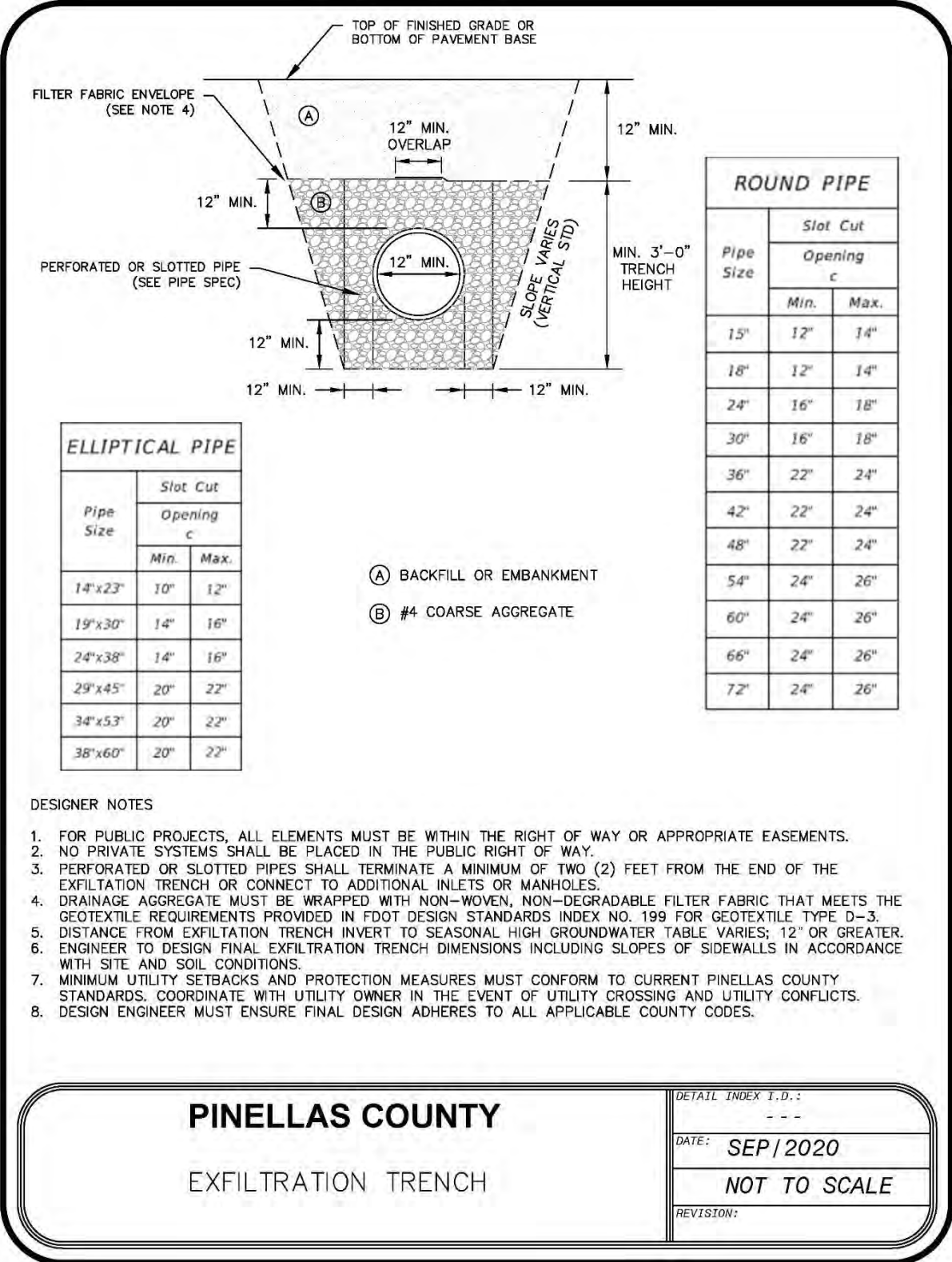

Figure 4.2.1: Pinellas County CAD template for exfiltration trenches

4.2.3. Calculating Load Reduction Efficiency for a Given Retention Volume

Use **Table 6.10.4 in Part C-Design Guide** to determine the treatment volume needed to achieve an 80% pollutant load reduction.



If exfiltration trenches are being used in a BMP treatment train to achieve part of the required pollutant load reduction use **Table 6.10.5** to determine the percent reduction associated with various treatment volumes. Also use **Table 6.10.5** to determine the treatment volume associated with the required nutrient load reduction to achieve the performance standard of reducing nutrient loads by at least 10% from current discharges.

4.2.4. Design and Performance Criteria

- (a) Exfiltration trenches must have the capacity to retain the required treatment volume without a discharge and without considering soil storage.
- (b) The required treatment volume initially will be retained in the perforated/slotted pipe and the surrounding aggregate reservoir.
- (c) Exfiltration trenches will only be permitted for projects to be operated by entities with single owners or entities with full-time maintenance staffs.
- (d) The exfiltration trench must provide the capacity for the required treatment volume of stormwater within 72 hours, with a safety factor of two, following a storm event assuming average antecedent runoff condition (ARC 2). In exfiltration systems, the stormwater is drawn down by natural soil infiltration and dissipation into the ground water table as opposed to underdrain systems that rely on artificial methods such as stormwater pipes. A recovery analysis is required that accounts for the mounding of ground water beneath the exfiltration system. Details related to safety factors, mounding analysis and supporting soil testing is provided in Appendix A of this Manual.
- (e) Minimum perforated or slotted pipe diameter will be twelve inches. Pipe will not exceed 45° bends.
- (f) Minimum aggregate reservoir trench width will be three feet.
- (g) To ensure recovery of the Required Treatment Volume (RTV), a dry exfiltration trench must be designed so that the invert elevation of the trench is at least two feet above the seasonal high ground water table elevation unless the applicant demonstrates, based on plans, test results, calculations, or other information, that an alternative design is appropriate for the specific site conditions.

If there is not two feet of separation from the bottom of the exfiltration system to the season high (SHWT), the engineer of record must provide a mounding analysis to demonstrate required performance.

Refer to Figure 4.2.1 for additional information.

- (h) To prevent surrounding soil migration into the aggregate reservoir, the reservoir must be enclosed on all sides by a permeable woven or non-woven filter fabric. The permeability of the filter fabric must be greater than the permeability of the surrounding soil.
- (i) To facilitate inspection of proper operation and maintenance of the exfiltration system, the system must be designed with sufficient access for inspection. Appropriate inspection access is dependent on the design of the specific system, but all must provide the ability to determine whether the system is maintaining the design infiltration rate and storage volume. Examples of acceptable inspection methods include designing the system such that the terminal ends of any perforated/slotted pipe or storage areas either:

- Terminating in an accessible stormwater inlet or manhole; or
- Having an eight-inch minimum diameter inspection port installed at any terminal “dead end” of any perforated/slotted pipe or storage areas or at the terminal of any sweep in end no greater than 45° bend and 300 feet long.
- Having an observation well that allows checking of the recovery of the RTV.

Refer to Figure 4.2.3 for additional information and recommendations.

- (j) To provide a collection space for trash and other inflow debris, a minimum 24-inch-deep maintenance sump will be required for all system inlets and manholes. A minimum twelve-inch diameter weep hole will be placed in the bottom of the maintenance sump to facilitate the infiltration of stormwater into the underlying soils after a rainfall event. Refer to Figure 4.2.3 for additional information and recommendations.
- (k) To reduce the potential for trash, debris and oil/grease inflow into the exfiltration trench system; a baffle, trash tee or other equivalent device must be installed at the end of the perforated/slotted pipe(s) in all access inlets and manholes. Refer to Figures 4.2.4 and 4.2.5 for additional information and recommendations.
- (l) Sustainable void spaces may be used in computing the storage volume in the aggregate reservoir. The aggregate void space values will be the greater of the following:
 - 30% of total stone aggregate volume to be counted towards volume calculations above seasonal highwater elevation; or
 - 80% of the measured testing lab values for the selected aggregate(s), if obtained and certified by a Florida licensed geotechnical professional.
- (m) The material used in the aggregate reservoir will be washed to assure that no more than five percent (5%) of the materials passing a #200 sieve.
- (n) Exfiltration trenches will not be constructed within 50 feet of a public or private potable water supply well or within 15 feet of an onsite wastewater disposal and treatment system.

4.2.5. Required Site Information

Design of an exfiltration system must consider site conditions including soil, geology, and water table conditions. Specific data and analyses required for the design of an exfiltration trench are set in Appendix A of this Manual.

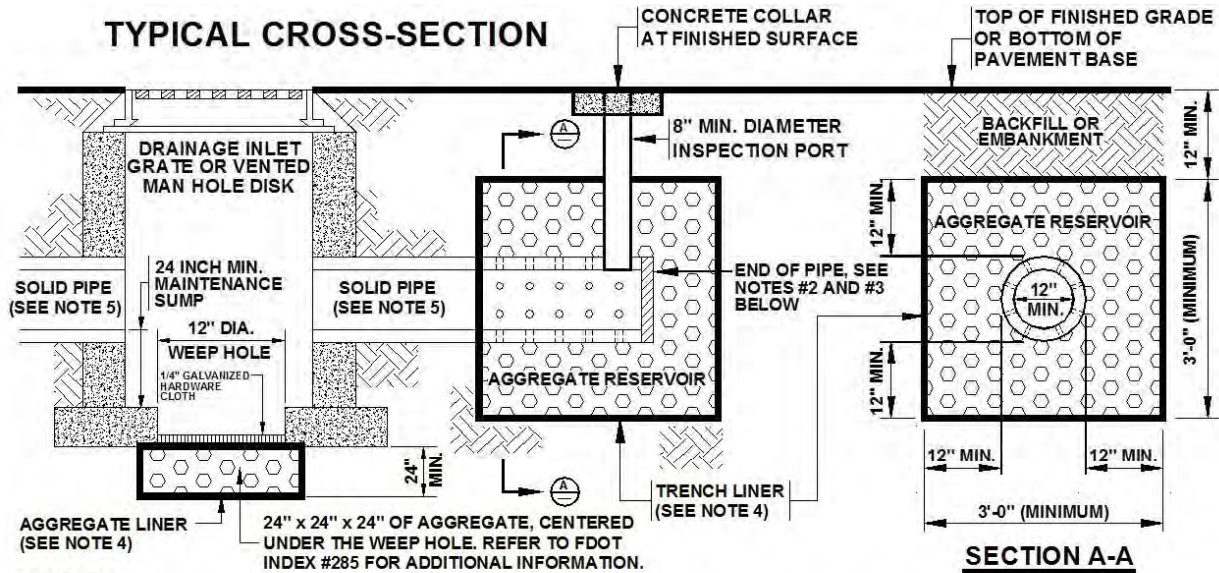

NOTES:

1. SEE THE SEPARATE DETAIL SKETCHES FOR SEDIMENT / TRASH BAFFLES & TEES, OR OTHER EQUIVALENT DEVICES.
2. PERFORATED OR SLOTTED PIPES SHALL TERMINATE A MINIMUM OF TWO (2) FEET FROM THE END OF THE EXFILTRATION TRENCH, OR CONNECT TO ADDITIONAL INLETS OR MANHOLES.
3. PIPE "DEAD ENDS" (IF UTILIZED) SHALL TERMINATE INTO A SOLID PLUG OR END CAP.
4. SIDES, TOP, BOTTOM, AND ENDS OF TRENCH (AND AGGREGATE BELOW DRAIN HOLE) SHALL BE LINED WITH A PERVIOUS WOVEN OR NON-WOVEN ENGINEERING FILTER FABRIC. OVERLAP FABRIC LINING MATERIAL A MINIMUM OF TWELVE (12) INCHES AT THE TOP OF THE AGGREGATE.
5. REFER TO FDOT INDEX #285 FOR ADDITIONAL INFORMATION ON THE MINIMUM LENGTHS OF SOLID PIPE EXITING THE ACCESS MANHOLE OR DRAINAGE INLET, AND THE MINIMUM CROSS SECTIONAL DIMENSIONS OF THE AGGREGATE RESERVOIR.

"GENERIC" EXFILTRATION TRENCH SUMPS & DEAD END DETAILS

NOT TO SCALE

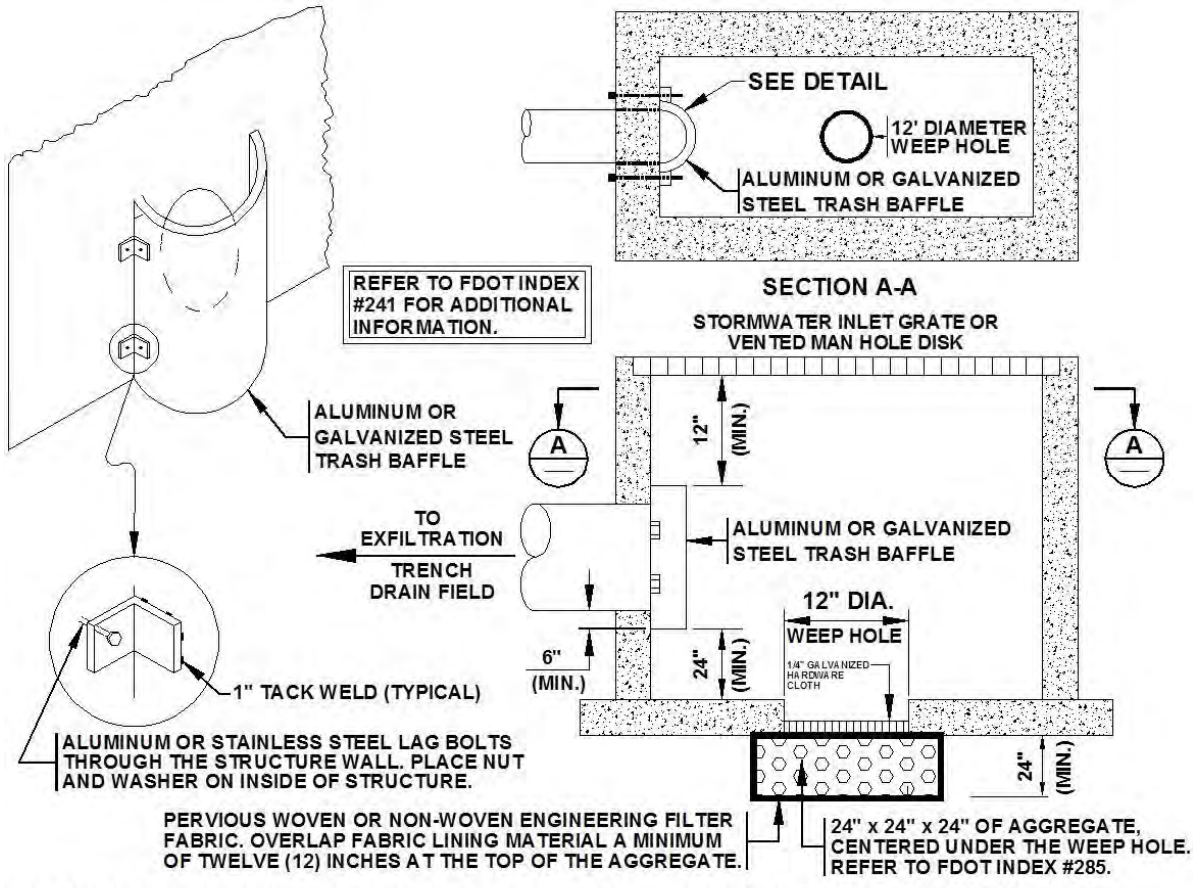

"GENERIC" DETAIL FOR AN EXFILTRATION TRENCH SEDIMENT / TRASH BAFFLE

NOT TO SCALE

Figure 4.2.4. Detail for Exfiltration Trench Trash Baffle

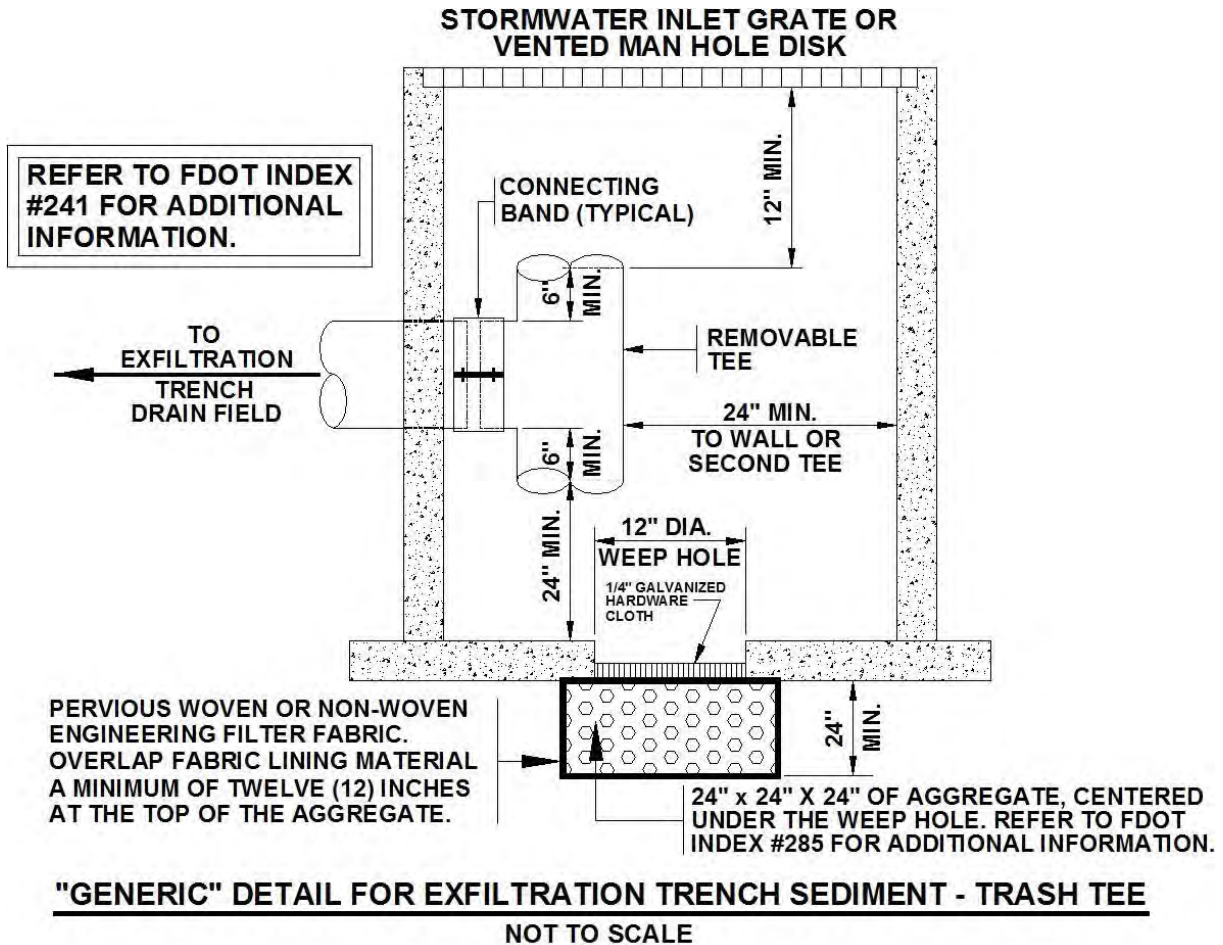

Figure 4.2.5. Generic Detail for a Typical Exfiltration Trench Trash Tee

4.2.6. Construction requirements

During construction, every effort should be made to limit the parent soil and debris from entering the trench. Any method used to reduce the amount of fines entering the exfiltration trench during construction will extend the life of the system.

- (a) The location and dimensions of the exfiltration trench will be verified onsite prior to trench construction. All design requirements including trench dimensions and distances to foundations, septic systems, wells, etc., need to be verified.
- (b) To minimize sealing of the soil surface, the trench will be excavated with a backhoe rather than front-end loaders or bulldozers whose blades will seal the infiltration soil surface.
- (c) Excavated materials will be placed a sufficient distance from the sides of the excavated area to minimize the risk of sidewall cave-ins and prevent the material from re-entering the trench.
- (d) The trench bottom and side walls will be inspected for materials that could puncture or tear the filter fabric, such as tree roots, and assure they are not present.
- (e) The aggregate material will be inspected prior to placement to ensure it meets size specifications and is washed to minimize fines and debris.

- (f) Inflows to the trench will be temporarily blocked until the contributing watershed area is stabilized to prevent sediment from entering and clogging the trench.
- (g) An applicant may propose alternative construction procedures to assure that the permitted infiltration rate of the constructed exfiltration trench is met provided they are acceptable and approved by the County.

4.2.7. Inspections, Operation and Maintenance

(a) Inspection Items:

(1)	Monitor facility for sediment accumulation in the pipe (when used) and storage volume recovery (i.e., drawdown capacity). Observation wells and inspection ports should be checked following 3 days minimum dry weather. Failure to percolate stored runoff to the design treatment volume level within 72 hours indicates binding of soil in the trench walls and/or clogging of geotextile wrap with fine solids. Reductions in storage volume due to sediment in the distribution pipe, also reduces efficiency. Minor maintenance measures can restore infiltration rates to acceptable levels short term. Major maintenance (total rehabilitation) is required to remove accumulated sediment in most cases or to restore recovery rate when minor measures are no longer effective or cannot be performed due to design configuration.
(2)	Inspect appurtenances such as sedimentation and oil and grit separation traps or catch basins as well as diversion devices and overflow weirs when used. Diversion facilities and overflow weirs should be free of debris and ready for service. Sedimentation and oil/grit separators should be scheduled for cleaning when sediment depth approaches cleanout level. Cleanout levels should be established not less than 1 foot below the invert elevation of the chamber.

(b) Maintenance As-Needed To Prolong Service:

(1)	Remove sediment from sediment or oil/grease traps, catch basin inlets, manholes, and other appurtenant structures and dispose of properly.
(2)	Remove debris from the outfall or "Smart Box" (diversion device in the case of off-line facilities).
(3)	Removal of sediment and cleaning of trench system. This process normally involves facilities with large pipes. Cleanout may be performed by suction hose and tank truck and/or by high-pressure jet washing.

(c) Maintenance As-Needed to Maintain 72-Hour Exfiltration Rate:

(1)	Periodic clean-out or rehabilitation of the system to remove any accumulated trash, sediment and other inflow debris and remediate any clogging of perforated pipes.
(2)	Total replacement of the system. In some cases, the system may not be able to be rehabilitated sufficiently to restore the design storage and infiltration rate. In these cases, complete replacement of the system may be necessary. The applicant will provide an estimate of the expected life expectancy of the exfiltration trench and an estimate of the cost to replace the trench.

4.3. Underground Retention Systems Design Criteria

4.3.1. Description

Underground retention systems are special types of storage systems that capture the Required Treatment Volume (RTV) in an underground storage system and “drain field.” Generally, these systems consist of lightweight, high strength modular units with “open” bottoms to allow for soil infiltration (refer to Figure 4.3.1 below). These systems are sometimes used where land values are high, and the owner/applicant desires to minimize the potential loss of usable land with other types of retention Best Management Practices (BMPs). Underground retention systems are not intended to have human access for maintenance.

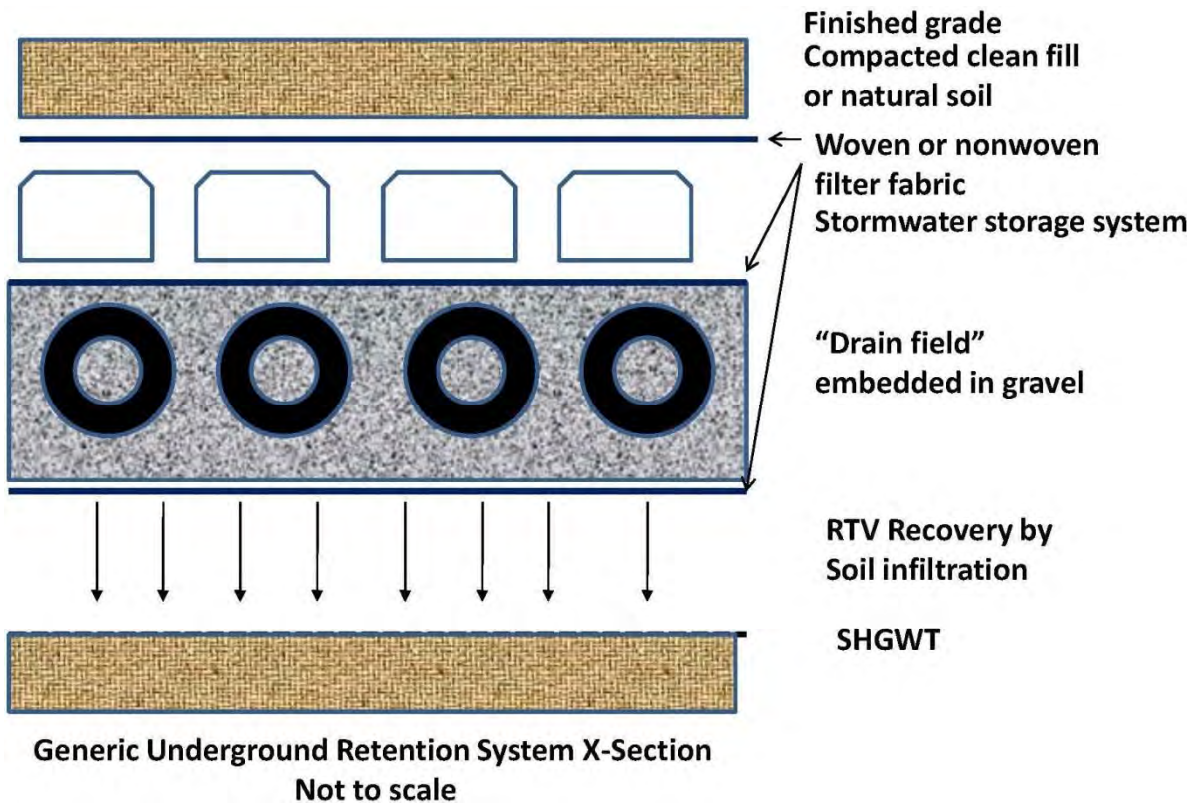

Figure 4.3.1. Generic Underground Retention System

UNDERGROUND RETENTION SUMMARY

Advantages/Benefits	Reduces stormwater volume, peak discharge rate, pollutant loadings, and heat island effect. Provides ground water recharge and enhanced site development potential.
Disadvantages/Limitations	Only permitted for projects to be operated by entities with single owners or with full-time maintenance staff. Do not construct within 50 feet of a public or private potable water supply well or within 15 feet of an onsite wastewater disposal and treatment system. Site must have appropriate soil and SHGWT conditions for infiltration. Not appropriate on sites with potential hazardous or toxic materials.
Volume Reduction Potential	High
Pollutant Removal Potential	High for all pollutants
Key design considerations	SHGWT at least 2 feet below bottom; recovery of treatment volume within 24 – 72 hours; pretreatment via swales or catch basins essential to prevent litter, trash, leaves, and other debris from entering exfiltration trench; a baffle, trash tee or other equivalent device must be installed at the end of the perforated/slotted pipe(s) in all access inlets and manholes.
Key construction and maintenance considerations	Minimize soil compaction and sedimentation during construction; block Inflows to the system until the contributing watershed area is stabilized. ensure design infiltration is met after construction; inspect during wet season to see if water is ponding and not infiltrating properly; restore infiltration capacity as needed to meet permit requirements

4.3.2. Required Treatment Volume

The Required Treatment Volume (RTV) necessary to achieve the needed treatment efficiency will be routed to the underground storage and retention system and percolated into the ground. These systems must be properly sized to retain the required treatment volume as set forth in the performance standards in **Section 3.1.1** of this Manual.

Treatment volumes to achieve the necessary efficiencies will be determined based on the percentage of directly connected impervious area (DCIA) and the weighted curve number for non-DCIA areas as set forth in Table 6.10.4 and Table 6.10.5. It is worth noting that the integration of Green Infrastructure elements into the site design could have the two-fold benefit of reducing the percentage of DCIA, while simultaneously attenuating/treating runoff from the site and, as such, reducing the volume of surface runoff and pollutant loading to the underground storage and retention system.

4.3.3. Calculating Load Reduction Efficiency for a Given Retention Volume

Use **Table 6.10.4** to determine the treatment volume needed to achieve the presumptive 80% pollutant load reduction.



If underground storage and retention systems are being used in a BMP treatment train to achieve part of the required pollutant load reduction use **Table 6.10.5** to determine the percent reduction associated with various treatment volumes. Also, use **Table 6.10.5** to determine the treatment volume associated with the required nutrient load reduction to achieve the performance standard of reducing nutrient loads by at least 10% from current discharges.

4.3.4. Design Criteria

- (a) The underground storage and retention system must have the capacity to retain the required treatment volume without a discharge and without considering soil storage.
- (b) The underground storage and retention system must recover the required treatment volume of stormwater within 72 hours, with a safety factor of two, assuming average Antecedent Runoff Condition (ARC 2). A recovery analysis is required that accounts for the mounding of ground water beneath the retention basin. Details related to safety factors, mounding analysis and supporting soil testing is provided in Appendix A of this Manual.
- (c) The seasonal high ground water table will be at least two feet beneath the bottom of the underground storage and retention system.
- (d) Sustainable void spaces may be used in computing the storage volume in the aggregate reservoir. These aggregate void space values will be the greater of the following:
 - 30% of total stone aggregate volume to be counted towards volume calculations above seasonal highwater elevation; or
 - 80% of the measured testing lab values for the selected aggregate(s), if obtained and certified by a Florida licensed geotechnical professional.
- (e) Minimum perforated or slotted pipe diameter of 12 inches.
- (f) Minimum aggregate reservoir trench width of three feet.
- (g) To minimize the loss of the Required Treatment Volume (RTV), the underground retention system must be designed so that the invert elevation of the trench must be at least two feet above the seasonal high ground water table elevation unless the applicant demonstrates, based on plans, test results, calculations or other information, that an alternative design is appropriate for the specific site conditions.
- (h) To facilitate inspection/maintenance of the underground retention system, the terminal ends of the

perforated/slotted pipe must either:

- Terminate in an accessible stormwater inlet or manhole;
- Have an eight-inch minimum diameter inspection port installed at any terminal “dead end” of the perforated/slotted pipe; or
- Have an observation well that allows checking of the recovery of the RTV.

Refer to Figure 4.2.3 for additional information and recommendations. Alternatively, the applicant may propose a system that is manufactured with an equivalent functional component that would provide for inspection and maintenance.

- (i) To provide a collection space for trash and other inflow debris, a minimum 24-inch-deep maintenance sump will be required for all system inlets and manholes. A minimum 12-inch diameter weep hole will be placed in the bottom of the maintenance sump to facilitate the infiltration of stormwater into the underlying soils after a rainfall event. Refer to Figure 4.2.3 for additional information and recommendations. Alternatively, the applicant may propose a system that is manufactured with an equivalent functional component that would capture trash and other inflow debris and keep it out of the retention system.
- (j) To reduce the potential for trash, debris and oil/grease inflow into the underground retention system; a baffle, trash tee or other equivalent device must be installed at the end of the perforated/slotted pipe(s) in all access inlets and manholes. Refer to Figures 4.2.4 and 4.2.5 for additional information and recommendations. Alternatively, the applicant may propose a system that is manufactured with an equivalent functional component that would capture trash, debris, and oil/grease inflow into the underground retention system.
- (k) The Required Treatment Volume (RTV) will be initially retained in the perforated/slotted pipe and the surrounding aggregate reservoir.
- (l) Underground storage and retention systems will not be constructed within 50 feet of a public or private potable water supply well or within 15 feet of an onsite wastewater disposal and treatment system.

4.3.5. Required Site Information

Design of an underground storage and retention system must carefully consider site conditions including soil, geology, and water table conditions. Specific data and analyses required for the design of an underground storage and retention system are set forth in Appendix A.

4.3.6. Construction requirements

The following construction procedures are required to avoid degradation of underground retention system infiltration capacity due to construction practices:

- (a) The location of underground retention system will be clearly marked at the site to prevent unnecessary vehicular traffic across the area causing soil compaction.
- (b) During construction, erosion and sediment controls will be used to minimize the amount of soil, especially the amount of fines, and debris entering the system.
- (c) During construction, inlet pipes will be temporarily plugged, to prevent soil and debris from entering the system.
- (d) The underground retention system should not be placed into operation until the contributing watershed area is stabilized and the pretreatment sumps are constructed.

4.3.7. Inspections, Operation and Maintenance

(a) General

Regular, routine inspection and maintenance is an important component of this type of underground system to ensure that it functions in a satisfactory manner. The maintenance intervals for an underground retention system are typically more frequent than standard “dry” retention ponds. The performance of the underground system will be related to the effectiveness of the up-gradient sediment/trash removal devices (refer to Figures 4.2.2 and 4.2.3), and the frequency of inspections and maintenance activities for all of the underground retention system’s components.

The guidelines outlined below are intended to provide a comprehensive schedule that gives reasonable assurance that the County requirements and recommendations are being met.

(b) Indication of system failure:

Standing water over sub-grade soils at the bottom of the underground retention system 72 hours after a storm event typically indicates system failure. Long-term system failures are generally the result of inadequate/improper O&M procedures within the up-gradient sediment / trash removal devices, and/or within the underground retention system itself.

(c) Sub-grade Soil Maintenance

The sub-grade soils at the bottom of this system are the only mechanism to provide water quality treatment (soil infiltration of the RTV). Therefore, the designed hydraulic conductivity rates within this soil must be maintained. Inspection ports and access manholes/trench grates are provided to facilitate ongoing inspection and maintenance activities. Failure to repair inflow/outflow scour erosion damage, or to remove detrimental materials (i.e., trash, clays, lime rock debris, organic matter, etc.), will result in lower soil hydraulic conductivity rates, and subsequent system failure. Manual methods can be used for this required maintenance. However, the use of a vacuum truck for contaminate removal may be a more practical means of providing for the removal of these detrimental materials and sediments. Disposal of these contaminants will be in an approved landfill facility.

(d) Recommended inspection frequency

(1)	<i>After a large storm event of greater than one inch of rainfall:</i> To ensure the (continued) free flow of stormwater, inspect the system and remove accumulated trash and debris from the up-gradient sediment/trash removal devices, and the inflow and outflow points of the down-gradient underground retention system.
(2)	<i>Every six months:</i> Perform a comprehensive inspection of the underground retention system for accumulated trash, debris and organic matter, and remove/dispose of these contaminants to ensure unimpeded stormwater flow. As appropriate, clean the surface of the sub-grade sands by raking, and check for accumulations in the various underground areas. If the sediment/contaminate accumulation is greater than two inches, a vacuum truck and/or similar equipment may be necessary for removal operations. Removed contaminants will be taken to an approved offsite landfill.
(3)	<i>Annually, during September-November:</i> Monitoring of the drawdown time for the stormwater through the sub-grade sands will be done to ensure recovery within 72 hours after the last rainfall event. Monitoring and observation of the drawdown times can be done visually through the inspection ports or observation well after a storm event. The drawdown of the water quality treatment volume (RTV) must recover within 72 hours after the storm event. If appropriate, post-construction hydraulic conductivity testing of the non-compacted soil floor

	[and their subsequent (certified) reports] will be performed by the appropriate Florida licensed professional. Any post-construction soil testing reports will be submitted to the County upon request.
(4)	Drawdown times that exceed 72 hours are indicative of sub-grade clogging and will likely require the removal of contaminants and raking of the sub-grade soils. The actual depth of removal can be done visually by looking at the discoloration of the entrapped fine silts, hydrocarbons (greases, oils), and organic matter. If required, replacement sub-grade soils must meet the design specifications under the original permit authorization.
(5)	In addition to the sub-grade soils, other elements of the stormwater management system such as pipes, inlets, geotextile fabric, gravel, sediment/trash removal devices, etc., are to be inspected and repaired/replaced if needed.

(e) Recommended Maintenance Activities

(1)	Monitor facility for sediment accumulation in the pipe (when used) and storage volume recovery (i.e., drawdown capacity). Observation wells and inspection ports should be checked following three days minimum dry weather. Failure to percolate stored runoff to the design treatment volume level within 72 hours indicates binding of soil within the system with fine solids. Reductions in storage volume due to sediment in the distribution pipe, also reduces efficiency. Minor maintenance measures can restore infiltration rates to acceptable levels short term. Major maintenance (total rehabilitation) is required to remove accumulated sediment in most cases or to restore recovery rate when minor measures are no longer effective or cannot be performed because of design configuration.
(2)	Inspect appurtenances such as sedimentation and oil and grit separation traps or catch basins as well as diversion devices and overflow weirs when used. Diversion facilities and overflow weirs should be free of debris and ready for service. Sedimentation and oil/grit separators should be scheduled for cleaning when sediment depth approaches cleanout level. Cleanout levels should be established not less than one foot below control elevation of the chamber.

(f) Maintenance As-Needed to Prolong Service:

(1)	Remove sediment from sediment or oil/grease traps, catch basin inlets, manholes, and other appurtenant structures and dispose of properly.
(2)	Remove debris from the outfall or "Smart Box" (diversion device in the case of off-line facilities).

(g) Maintenance As-Needed to Maintain 72-Hour Infiltration Rate:

(1)	Periodic clean-out/rehabilitation of the system to remove any accumulated trash, sediment and other inflow debris and remediate any clogging of perforated pipes, aggregates and geotextile fabrics.
(2)	Total replacement of the system. In some cases, the system, may not be able to be rehabilitated sufficiently to restore the design storage and infiltration rate. In these cases, complete replacement of the system may be necessary. During replacement, any removed sediment, contaminated soil, coarse aggregate, and filter cloth will be disposed of properly.

4.4. Bioswales/Treatment Swales/Green Gutters

4.4.1. Description

Swales have been used for the conveyance of stormwater along roads for decades. However, swales can also be used for stormwater treatment, especially as part of a BMP Treatment Train, when properly designed and maintained to provide retention and infiltration of stormwater.

Swales are hereby defined as follows:

“Swale means a manmade trench which:

- (1) Contains contiguous areas of standing or flowing water only following a rainfall event,*
- (2) Is planted with or has stabilized vegetation suitable for soil stabilization, stormwater treatment, and nutrient uptake, and*
- (3) Is designed to take into account the soil erodibility, soil percolation, slope, slope length, and watershed area so as to prevent erosion and reduce pollutant concentration of any discharge.”*

Swales are inline retention systems and their treatment effectiveness is directly related to the amount of the annual stormwater volume that is infiltrated. Swales designed for stormwater treatment could be referred to as:

- Treatment Swales with blocks;
- Bio-Swales;
- Green Gutters

BIOSWALES/TREATMENT SWALES/GREEN GUTTERS SUMMARY

Advantages/Benefits	Used as part of a BMP treatment train, sometimes for conveyance. Reduces stormwater volume, peak discharge rate, pollutant loadings, and heat island effect. Provides ground water recharge and enhanced site aesthetics. Can be integrated into the landscaping.
Disadvantages/Limitations	Do not construct within 50 feet of a public or private potable water supply well or within 15 feet of an onsite wastewater disposal and treatment system. Site must have appropriate soil and SHGWT conditions for infiltration. Not appropriate on sites with potential hazardous or toxic materials.
Volume Reduction Potential	Moderate to High.
Pollutant Removal Potential	Moderate to High for all pollutants
Key design considerations	Minimum infiltration rate through the vegetation and soil is at least one inch per hour; SHGWT at least two feet below bottom; recovery of treatment volume within 24 – 72 hours; sides and bottoms must be stabilized with vegetation or other approved materials; bottom at least two feet wide for easier mowing.
Key construction and maintenance considerations	Minimize soil compaction and sedimentation during construction; ensure design infiltration is met after construction; inspect during wet season to see if water is ponding and not infiltrating properly; restore infiltration capacity as needed to meet permit requirements.

4.4.2. Design considerations for these Linear Retention Systems

A treatment swale with blocks (or in certain instances a raised driveway culvert that serves as the block), a bio-swale, or a green gutter are essentially linear retention systems in which the treatment volume is retained and allowed to percolate. The treatment volume necessary to achieve the required treatment efficiency will be routed to the swale and percolated into the ground before overflow and discharge. Linear retention swales are designed following the requirements for retention systems in Section 4.1 and the design criteria specific to swales in Section 4.4.5 of this Manual. This type of swale system is recommended along linear routes such as sidewalks, multi-use trails, brick roads, and other similar applications.



PK Avenue bioswale – Auburndale, FL

4.4.3. Required Treatment Volume

The required nutrient load reduction will be determined by the type of water body to which the swale and associated BMP treatment train discharges and the associated performance standard as set forth in Section 3.1.1 of this Manual. The treatment volume necessary to achieve the desired treatment efficiency will be routed to the swale and associated BMP treatment train before discharge. The nutrient load reduction credit assigned to the conveyance swale will be based on the annual volume of stormwater that is retained in the swale and not discharged to the downstream BMP. This volume will be calculated using the equations in Section 6.10 in Part C-Design Guide.



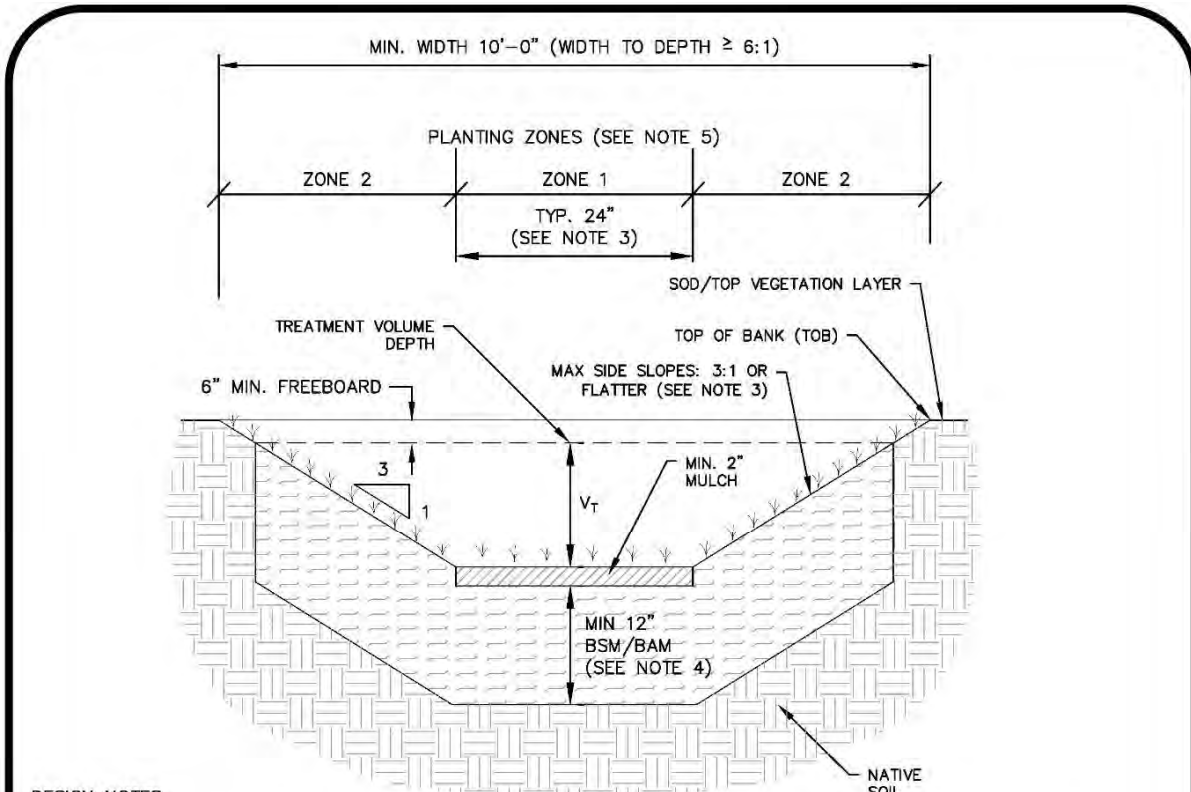

DESIGN NOTES

1. FOR PUBLIC PROJECTS, ALL ELEMENTS MUST BE WITHIN THE RIGHT OF WAY OR APPROPRIATE EASEMENTS.
2. NO PRIVATE SYSTEMS SHALL BE PLACED IN THE PUBLIC RIGHT OF WAY.
3. ALL DIMENSIONS CAN BE MODIFIED TO FIT SITE CONSTRAINTS; WIDTHS LESS THAN 2' ARE NOT RECOMMENDED. MODIFICATIONS MUST BE DESIGNED BY LICENSED ENGINEER. SIDE SLOPES STEEPER THAN 3:1 (H:V) REQUIRE REINFORCEMENT OF SIDEWALLS.
4. BIORETENTION SOIL MIX (BSM) SHOULD CONSIST OF 30-40% COMPOST AND 60-70% SAND BY VOLUME. SEE BSM AND BAM SPECIFICATIONS.
5. REFER TO LIST OF COUNTY APPROVED PLANTINGS AND SPEC SHEET FOR PLANTING DESIGN AND MAINTENANCE INFORMATION.
6. VEGETATED SYSTEMS MUST BE ABLE TO RECOVER REQUIRED TREATMENT VOLUME IN 24 TO 36 HOURS TO PREVENT DAMAGE TO VEGETATION.
7. HARDWOOD MULCH MATERIAL MUST BE USED PER PINELLAS COUNTY STORMWATER MANUAL SPECIFICATIONS.
8. BIOSWALE LENGTHS AND DEPTH CAN VARY TO ACHIEVE TREATMENT VOLUME; V/T .
9. POSITIVE OUTFALL REQUIRED TO BE DESIGNED BY ENGINEER. DESIGN LONGITUDINAL SLOPES SHALL NOT CAUSE EROSION.
10. REQUIRED MIN. DISTANCE OF 12" FROM BOTTOM OF BIOSWALE TO SEASONAL HIGH GROUNDWATER TABLE (SHGWT).
11. UNDERDRAIN SYSTEM REQUIRED IF THE SEASONAL HIGH GROUNDWATER TABLE IS LESS THAN 12" BELOW THE BOTTOM OF THE ENGINEERED SOIL/BAM LAYER OR IF NATIVE SOIL INFILTRATION DOES NOT FACILITATE ADEQUATE INFILTRATION. UNDERDRAIN TO BE DESIGNED BY ENGINEER PER PINELLAS COUNTY DETAIL INDEX NUMBER 1290.
12. MINIMUM UTILITY SETBACKS AND PROTECTION MEASURES MUST CONFORM TO CURRENT PINELLAS COUNTY STANDARDS. COORDINATE WITH UTILITY OWNER IN THE EVENT OF UTILITY CROSSING AND UTILITY CONFLICTS.
13. DESIGN ENGINEER MUST ENSURE FINAL DESIGN ADHERES TO ALL APPLICABLE COUNTY CODES.

PINELLAS COUNTY	DETAIL INDEX I.D.:
BIO-SWALES	---
	DATE: SEP/2020
	NOT TO SCALE
	REVISION:

Figure 4.4.1. Pinellas County CAD template for bioswales

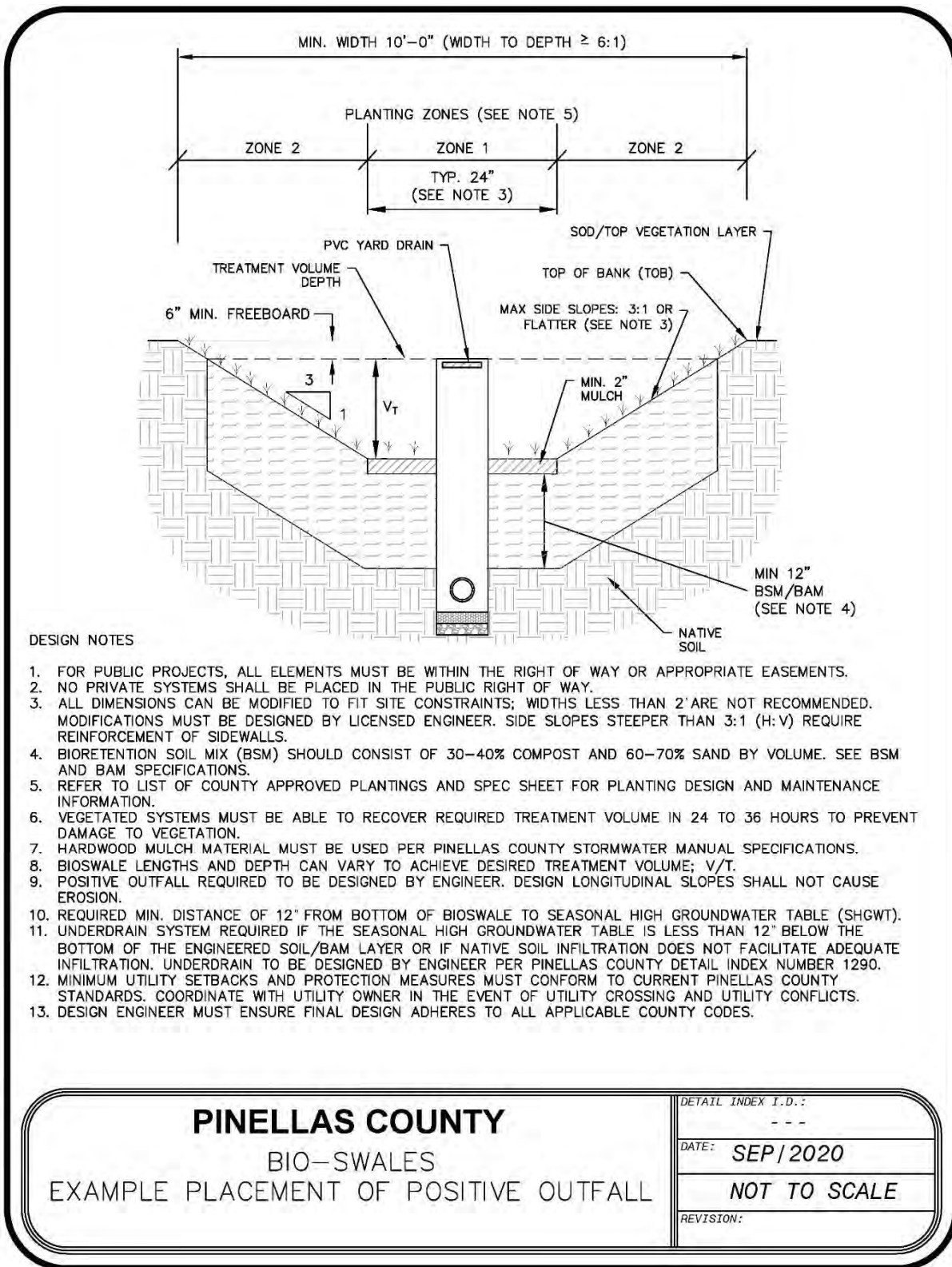
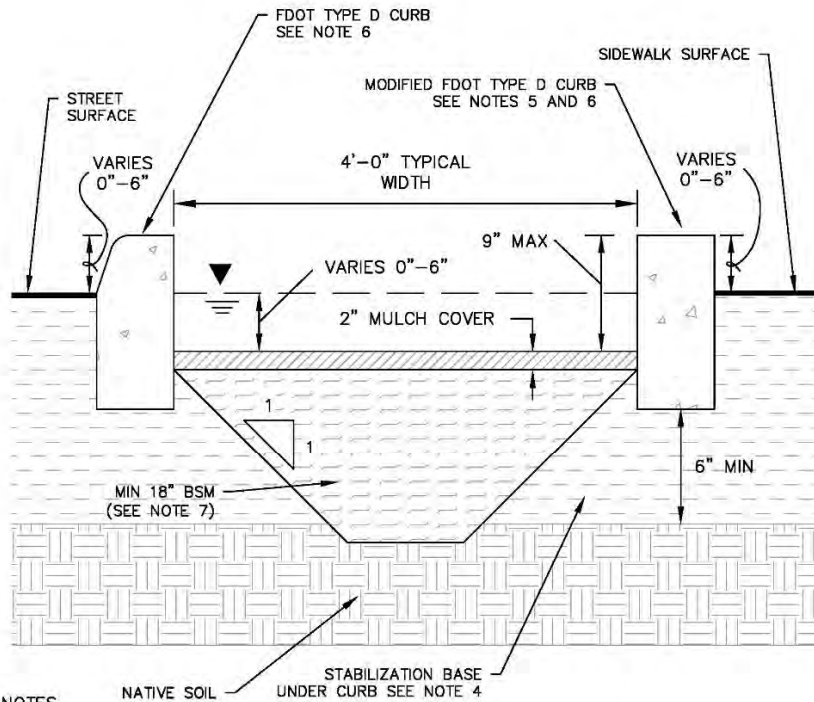

Figure 4.4.2. Pinellas County CAD template for bioswales with positive outfall



DESIGN NOTES

1. FOR PUBLIC PROJECTS, ALL ELEMENTS MUST BE WITHIN THE RIGHT OF WAY OR APPROPRIATE EASEMENTS.
2. NO PRIVATE SYSTEMS SHALL BE PLACED IN THE PUBLIC RIGHT OF WAY.
3. ALL DIMENSIONS CAN BE MODIFIED TO FIT SITE CONSTRAINTS; WIDTHS LESS THAN 2' ARE NOT RECOMMENDED. MODIFICATIONS MUST BE DESIGNED BY LICENSED ENGINEER.
4. COMPACTED BASE TO 95% MIN. MODIFIED PROCTOR, 98% MAX. MODIFIED PROCTOR.
5. ANY TYPE D CURB MODIFICATIONS TO BE DESIGNED BY ENGINEER.
6. DRAINAGE INLET SLOT AND SPACING AS WELL AS OVERFLOW TO BE DESIGNED BY ENGINEER. TRAPEZOIDAL CURB OPENINGS ARE RECOMMENDED TO AVOID CLOGGING.
7. BIORETENTION SOIL MIX (BSM) SHOULD CONSIST OF 30-40% COMPOST BY VOLUME AND 60-70% SAND. SEE BSM AND BAM TECHNICAL SPECIFICATIONS.
8. HARDWOOD MULCH MATERIAL MUST BE USED PER PINELLAS COUNTY STORMWATER MANUAL SPECIFICATIONS.
9. VEGETATED SYSTEMS MUST BE ABLE TO RECOVER REQUIRED TREATMENT VOLUME IN 24 TO 36 HOURS TO PREVENT DAMAGE TO VEGETATION.
10. REQUIRED MIN. DISTANCE OF 24" FROM BOTTOM OF GREEN GUTTER TO SEASONAL HIGH GROUNDWATER TABLE (SHGWT).
11. UNDERDRAIN SYSTEM REQUIRED IF THE SEASONAL HIGH GROUNDWATER TABLE IS LESS THAN 24" BELOW THE BOTTOM OF THE ENGINEERED SOIL/BAM LAYER OR IF NATIVE SOIL INFILTRATION DOES NOT FACILITATE ADEQUATE INFILTRATION. UNDERDRAIN TO BE DESIGNED BY ENGINEER PER PINELLAS COUNTY DETAIL INDEX NUMBER 1290.
12. MINIMUM UTILITY SETBACKS AND PROTECTION MEASURES MUST CONFORM TO CURRENT PINELLAS COUNTY STANDARDS. COORDINATE WITH UTILITY OWNER IN THE EVENT OF UTILITY CROSSING AND UTILITY CONFLICTS.
13. DESIGN ENGINEER MUST ENSURE FINAL DESIGN ADHERES TO ALL APPLICABLE COUNTY CODES.

PINELLAS COUNTY

GREEN GUTTERS

DETAIL INDEX I.D.:

DATE: SEP/2020

NOT TO SCALE

REVISION:

- (a) Swales will be designed to infiltrate the required volume of stormwater needed to achieve the desired level of nutrient load reduction before discharging to the downstream BMP. Linear retention swales will be designed to infiltrate the required treatment volume as for retention systems as specified in Section 4.1.2 of this Manual.
- (b) The seasonal high ground water table will be at least two feet below the bottom of the swale unless the applicant demonstrates based on plans, test results, calculations or other information that an alternative design is appropriate for the specific site conditions.
- (c) The minimum infiltration rate through the vegetation and soil will be at least one inch per hour.
- (d) The lateral slope across the bottom of the swale will be flat to assure even sheet flow and prevent channelized flow and erosion.
- (e) Longitudinal slopes will not be so steep as to cause erosive flow velocities.
- (f) It is recommended that the bottom of the swale be at least two feet wide to facilitate mowing.
- (g) Off-street parking or other activities that can cause rutting or soil compaction is prohibited.
- (h) Swales will not be constructed within 50 feet of a public or private potable water supply well or within 15 feet of an onsite wastewater disposal and treatment system.

4.4.4. Soil Requirements and Testing Requirements

Swales will be constructed on soils that are capable of infiltrating the required treatment volume. Geotechnical testing of the underlying soil will be required to establish the depth to the Seasonal High Ground Water Table (SHGWT), the limiting infiltration rate (constant rate with time), and identification of the location of close-to-surface impermeable materials or layers that may require re-location of the swale. This SHGWT determination should be based on appropriate geotechnical testing and environmental field investigation, and not solely based on NRCS soil report information. Standard Penetration Tests (SPTs) and soil core testing are to be performed and signed/sealed by a licensed geotechnical engineer. Field investigation should be done by qualified professional(s) and can include things such as soil plugs and wetland indicators. Details related to safety factors, recovery/mounding analysis and supporting soil testing is provided in APPENDIX A of this Manual.

4.4.5. Construction and Stabilization Requirements

The following construction procedures are required to avoid degradation of the swale's infiltration capacity due to construction practices:

- (a) The location and dimensions of the swale system will be verified onsite prior to its construction. All design requirements including swale dimensions and distances to foundations, septic systems, and wells need to be verified.
- (b) The location of swales will be clearly marked at the site to prevent unnecessary vehicular traffic across the area causing soil compaction.
- (c) Excavation will be done by lightweight equipment to minimize soil compaction. Tracked, cleated equipment causes less soil compaction than equipment with tires.
- (d) Ensure that lateral and longitudinal slopes meet permitted design requirements and will not erode due to channelized flow or excessive flow rates.
- (e) Final grading and planting of the swale should not occur until the adjoining areas draining into the swale are stabilized. Any accumulation of sediments that does occur must be removed during the final stages of grading. The bottom should be tilled to produce a highly porous surface.
- (f) Ensure that measures are in place to divert runoff while vegetation is being established on the side

slopes and bottom of the swale. If runoff can't be diverted, vegetation will be established by staked sodding or by the use of erosion control blankets (with no plastic monofilament) or other appropriate methods.

- (g) Ensure that the vegetation used in the swale is consistent with values used for Manning's "n" in the design calculations.
- (h) An applicant may propose alternative construction procedures to assure that the design infiltration rate of the constructed and stabilized swale system basin is met provided it is acceptable and approved by the County.

4.4.6. Inspections, Operation and Maintenance Requirements

Maintenance issues associated with swales are related to clogging of the porous soils which reduces or prevents infiltration thereby slowing recovery of the stormwater treatment volume and often resulting in standing water. Clogging can result from erosion and sedimentation and the resulting sealing of the bottom or side slope soils. It can also occur from excessive loading of oils and greases or from excessive algal or microorganism growth.

To determine if a swale is properly functioning or whether it needs maintenance requires that an inspection be done during and soon after a storm. The inspection should determine if the swale is recovering its storage volume within its permitted time frames, generally 24 to 72 hours after a storm. If this is not occurring and results in standing water, then the cause of clogging must be determined, and appropriate actions undertaken beginning with those specified in the system's Operation and Maintenance Plan.

(a) Inspection Items:

(1)	Inspect swale for storage volume recovery within the permitted time, generally less than 72 hours. Failure to percolate the required treatment volumes indicates reduction of the infiltration rate and a need to restore system permeability
(2)	Inspect and monitor sediment accumulation on the bottom of the swale or at inflows to prevent clogging of the swale or the inflow pipes.
(3)	Inspect vegetation of bottom and side slopes to assure it is healthy, maintaining coverage, and that no erosion is occurring within the swale.
(4)	Inspect the swale for potential mosquito breeding areas such as where standing water occurs after 72 hours or where cattails or other invasive vegetation becomes established.
(5)	Inspect swale to determine if filling, excavation, construction of fences, or other objects are obstructing the surface water flow in the swales.
(6)	Inspect the swale to determine if it has been damaged, whether by natural or human activities.

(b) Maintenance Activities As-Needed to Prolong Service:

(1)	If needed, restore infiltration capability of the swale to assure it meets permitted requirements.
(2)	Remove accumulated sediment from swale and inflow or outflows and dispose of properly. Please note that stormwater sediment disposal may be regulated under Chapter 62-701, F.A.C. Sediment removal should be done when the swale is dry and when the sediments are cracking.
(3)	Remove trash and debris, especially from inflow or outflow structures, to prevent clogging or impeding flow.

(4)	Maintain healthy vegetative cover to prevent erosion of the swale bottom or side slopes. Mow grass as needed and remove grass clippings to reduce nutrient loadings.
(5)	Eliminate mosquito breeding habitats.
(6)	Remove fences or other obstructions that may have been built in the swale system.
(7)	Repair any damages to the swale system so that it meets permitted requirements.

4.5. Vegetated Natural Buffers

4.5.1. Description

Vegetated natural buffers (VNBs) are defined as areas with vegetation suitable for sediment removal along with nutrient uptake and soil stabilization that are set aside between developed areas and a receiving water or wetland for stormwater treatment purposes. They also can be used as the pre-filter for a bio-filtration system. Under certain conditions, VNBs are an effective best management practice for the control of nonpoint source pollutants in overland flow by providing opportunities for filtration, deposition, infiltration, absorption, adsorption, decomposition, and volatilization.

VNBs are most commonly used as an alternative to swale/ berm systems installed between backyards and the receiving water. Buffers are intended for use to avoid the difficulties associated with the construction and maintenance of backyard swales on land controlled by individual homeowners. Potential impacts to adjacent wetlands and upland natural areas are reduced because fill is not required to establish grades that direct stormwater flow from the back of the lot towards the front for collection in the primary stormwater management system. In addition, impacts are potentially reduced since buffer strips can serve as wildlife corridors, reduce noise, and reduce the potential for siltation into receiving waters.

Vegetative natural buffers are not intended to be the primary stormwater management system for residential developments. They are most commonly used only to treat those rear-lot portions of the development that cannot be feasibly routed to the system serving the roads and fronts of lots. A schematic of a typical VNB and its contributing area is presented in Figure 4.5.1. The use of a VNB in combination with a primary stormwater management system for other types of development will only be allowed if the applicant demonstrates that there are no practical alternatives for those portions of the project, and only if the VNB and contributing areas meet all of the requirements in this section of the Manual.

VEGETATED NATURAL BUFFER SUMMARY

Advantages/Benefits	Reduces stormwater volume, pollutant loadings, and heat island effect. Provides ground water recharge and enhanced site aesthetics.
Disadvantages/Limitations	Used to treat rear roof and rear yard runoff, especially for waterfront lots. Do not construct within 50 feet of a public or private potable water supply well or within 15 feet of an onsite wastewater disposal and treatment system. Site must have appropriate soil and SHGWT conditions for infiltration.
Volume Reduction Potential	Low to Moderate depending on site conditions and flow length.
Pollutant Removal Potential	Low to Moderate for all pollutants.
Key design considerations	Legal reservation of the VNB required; must have shallow sheet flow; minimum width of 25 feet; minimum length equal to the length of the contributing runoff area with maximum length of 100 feet; minimum infiltration rate through the vegetation and soil is at least one inch per hour; SHGWT at least 2 feet below bottom; recovery of treatment volume within 24 – 72 hours; sides and bottoms must be stabilized with natural or Florida-Friendly™ vegetation.
Key construction and maintenance considerations	Minimize disturbance of vegetation during construction; ensure design infiltration is met after construction; inspect during wet season to see if water is ponding and not infiltrating properly; restore infiltration capacity as needed to meet permit requirements; maintain vegetation as necessary.

4.5.2. Required Treatment

The treatment volume necessary to achieve the desired or required treatment efficiency will be routed to the VNB and percolated into the ground. The required nutrient load reduction is set forth in the performance standards set forth in **Section 3.1.1** of this Manual.

Treatment volumes to achieve the necessary efficiencies will be determined based on the percentage of directly connected impervious area (DCIA) and the weighted curve number for non-DCIA areas as set forth in Table 6.10.4 and Table 6.10.5.

Natural areas adjacent to rear-lots that have good infiltration potential are candidates for use as VNBs. Runoff from the rear-lot areas must be designed to percolate a specified portion of runoff as indicated below.

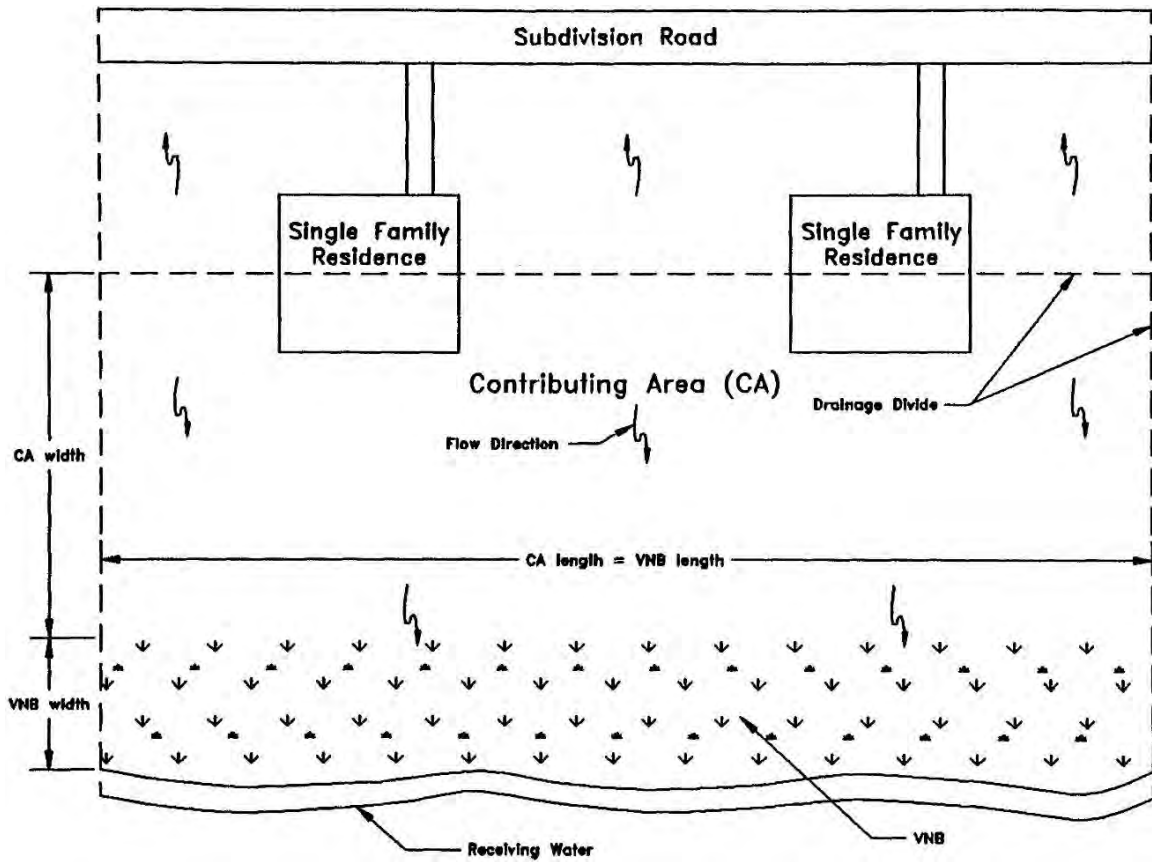

Figure 4.5.2. Plan View Schematic of Typical Vegetative Natural Buffer



4.5.3. Calculating Load Reduction Efficiency for a Given Retention Volume

Use Table 6.10.4 to determine the treatment volume needed to achieve an 80% pollutant load reduction if VNBs are being used to fully achieve the required level of pollutant load reduction.

When VNBs are being used as part of a BMP treatment train to achieve some level of pollutant load reduction but not the total amount of the required nutrient load reduction, use Table 6.10.5.

4.5.4. Design Criteria

- (a) Vegetated Natural Buffers will be designed to infiltrate the required treatment volume as specified in Section 4.5.2 of this Manual.
- (b) The contributing area is defined as the area that drains to the VNB. Only rear-lots of residential areas are allowed to contribute runoff to a VNB and then only if routing the runoff from such areas to the primary stormwater management system serving the development is not practical.
- (c) The seasonal high ground water table will be at least two feet below the bottom of the vegetated natural buffer unless the applicant demonstrates based on plans, test results, calculations or other information that an alternative design is appropriate for the specific site conditions.
- (d) The minimum infiltration rate through the vegetation and soil will be at least one inch per hour unless the applicant demonstrates based on plans, test results, calculations or other sufficient information that an alternative design is appropriate for the specific site conditions.
- (e) The minimum buffer width (dimension parallel to flow direction) will be 25 feet to provide adequate area for infiltration and the maximum VNB width will be 100 feet to ensure sheet flow conditions and the integrity of the treatment system. Factors affecting the minimum width (measured parallel to the direction of runoff flow) of VNB include infiltration rate, ground slope, rainfall, cover and soil characteristics, depth to water table and overland flow length. Infiltration is the primary means of treatment in vegetated natural buffers.
- (f) The maximum slope of VNB will not be greater than 6:1.
- (g) The length of the buffer (measured perpendicular to the runoff flow direction) must be at least as long as the length of the contributing runoff area (see Figure 4.5.1).
- (h) Runoff from the adjacent contributing area must be evenly distributed across the buffer strip to promote overland sheet flow. If the flow regime changes from overland to shallow concentrated flow, the buffer is effectively “short-circuited” and will not perform as designed.
- (i) The Property Association Documents and Conditions Covenants and Restrictions (CC&R's) will require that the contributing area must be stabilized with permanent vegetative cover that is consistent with the [Florida Friendly Landscaping™ program](#) and which is fertilized pursuant to the provisions of the [Pinellas County fertilizer regulations](#).
- (j) A legal reservation, in the form of an easement or other limitation of use, must be recorded which provides preservation of entire area of the VNB. The reservation must also include access for maintenance of the VNB unless the operation and maintenance entity wholly owns or retains ownership of the property.
- (k) The VNB area will be an existing undeveloped area that contains existing or planted vegetation suitable for infiltrating stormwater and soil stabilization. The existing vegetation, except exotic species, must not be disturbed during or after the construction of the project. If the VNB will be planted, the proposed list of [Florida-friendly™](#) plants must be submitted to the County for review. Maintenance will assure that the VNB contains less than ten percent coverage of exotic or nuisance plant species.

- (l) Erosion control measures as specified in Section 1.7 of this Manual must be used during development of the contributing area to prevent erosion or sedimentation of the vegetated natural buffer.
- (m) Vegetated natural buffers will not be constructed within 50 feet of a public or private potable water supply well or within 15 feet of an onsite wastewater disposal and treatment system.
- (n) The VNB and any required wetland buffer can be the same area provided that the functions and regulatory requirements for each are met.

4.5.5. Required Site Information

Successful design of a VNB system depends heavily upon conditions at the site, especially information about the soil, geology, and water table conditions. Specific data and analyses required for the design of a retention system are set forth in Appendix A of this Manual.

4.5.6. Construction Requirements

The following construction procedures are required to protect the VNB during planting, if needed, and to avoid degradation due to construction of the adjacent contributing area:

- (a) The location and dimensions of the VNB will be verified onsite prior to any construction. All design requirements including VNB dimensions and distances to foundations, septic systems, wells, etc. need to be verified.
- (b) The VNB will be clearly marked at the site to prevent equipment or vehicular traffic from entering the VNB (if a natural area) or to minimize compaction from any equipment entering the VNB during planting or establishment.
- (c) Ensure that the VNB buffer length, width, and slopes meet permitted design requirements.
- (d) Ensure that the VNB will not erode due to channelized flow or excessive flow rates.
- (e) Ensure that measures are in place to divert runoff from the VNB while the adjacent contributing area is being cleared and established. The adjacent contributing area will be stabilized as quickly as possible by sodding or by the use of erosion control blankets (with no plastic monofilament) or other appropriate methods.
- (f) Ensure that the vegetation planted in the VNB and adjacent contributing area meets [Florida-friendly™ landscaping](#) requirements and that all exotic plants are removed as specified in the permitted design.

4.5.7. Inspections, Operation and Maintenance

Maintenance issues associated with VNBs are related to integrity and damage to the natural or planted vegetation or the infiltration capabilities within the VNB. To determine if the VNB is properly functioning or whether it needs maintenance requires that an inspection be done during and soon after a storm. The inspection should determine if the VNB is providing sheet flow and infiltration of the required treatment volume within its permitted time frames, generally 24 to 72 hours after a storm. If this is not occurring, then the cause of must be determined and appropriate actions undertaken beginning with those specified in the system's Operation and Maintenance Plan.

Vegetated Natural Buffers must be inspected annually by the operation and maintenance entity to determine if there has been any encroachment or violation of the terms and condition of the VNB as described below. Reports documenting the results of annual inspections will be filed with the County every three years, or upon discovery of any encroachment or violation of design parameters, whichever occurs first.

- (a) Inspection Items:

(1)	Inspect VNB for storage volume recovery within the permitted time, generally less than 72 hours. Failure to percolate the required treatment volumes indicates reduction of the infiltration rate and a need to restore system permeability.
(2)	Inspect VNB to assure that inflow is via sheet flow, for areas of channelized flow through or around the buffer, and for areas with erosion or sediment accumulation indicating channelized flow or that stabilization of the adjacent contributing area is needed.
(3)	Inspect VNB for damage by foot or vehicular traffic or encroachment by adjacent property owners.
(4)	Inspect VNB for any signs of erosion or sedimentation.
(5)	Inspect VNB for the health and density of vegetation, and for the occurrence of exotic or nuisance plant species.

(b) Maintenance Activities As-Needed to Prolong Service:

(1)	If needed, restore infiltration capability of the VNB to assure it meets permitted requirements.
(2)	Repair any areas where channelized flow is occurring and restore sheet flow.
(3)	Repair any areas with erosion and carefully remove accumulated sediments if needed to assure the health and functioning of the VNB
(4)	Stabilize eroding parts of the adjacent contributing area as needed to prevent erosion and sedimentation.
(5)	Repair any damage to the VNB by foot or vehicular traffic and remove any fences or other materials that have been placed in the VNB by adjacent property owners.
(6)	Maintain the VNB vegetation and, if necessary, replant the VNB with approved Florida-Friendly™ vegetation as needed to assure sheet flow and prevent erosion and sedimentation. Remove any exotic or nuisance species including those listed as “Undesirable Species” provisions in Chapter 138, Article X, Division 3 - of the Pinellas County Code and on the Florida Exotic Pest Plant Council invasive plant list within the VNB.

All repairs to the VNB must be made as soon as practical in order to prevent additional damage to the buffer. Repaired areas must be re-established with approved [Florida-Friendly™](#) or [native](#) vegetation.

4.6. Pervious Pavement Systems

4.6.1. Description

Pervious pavement systems include the subsoil, the sub-base, and the pervious pavement (Figures 4.6.1 through 4.6.3). They can include several types of materials or designed systems such as pervious concrete, pervious aggregate/binder products, pervious paver systems, and modular paver systems. Pervious asphalt and pervious pavements using crushed and recycled glass will not be allowed unless product-specific information and verified testing results are provided to demonstrate sufficient structural capability and hydraulic performance. Recent studies on the design, longevity, and infiltration characteristics of pervious pavement systems are available on the University of Central Florida's website <http://stormwater.ucf.edu/>.

Pervious pavement systems are retention systems. They should be used as part of a treatment train to reduce stormwater volume and pollutant load from parking lots, or similar types of areas. As with all infiltration BMPs, the treatment efficiency is based on the amount of the annual runoff volume infiltrated which depends on the available storage volume within the pavement system, the underlying soil permeability, and the ability of the system to readily recover this volume.

PERVIOUS PAVEMENT SUMMARY

Advantages/Benefits	Reduces site imperviousness, stormwater volume, peak discharge rate, pollutant loadings, temperature, and heat island effect. Provides ground water recharge. Increases development potential of site.
Disadvantages/Limitations	More expensive than traditional pavement and more difficult to install and maintain. Limited to low traffic areas with limited structural load. Possible ADA issues for handicapped. Do not construct within 50 feet of a public or private potable water supply well or within 15 feet of an onsite wastewater disposal and treatment system. Site must have appropriate soil and SHGWT conditions for infiltration. Not appropriate on sites with potential hazardous or toxic materials. May not be appropriate on sites with high wind-blown sediment loading.
Volume Reduction Potential	Moderate to High depending on area with pervious pavement.
Pollutant Removal Potential	Moderate to High for all pollutants.
Key design considerations	Must use certified installer. Must use on areas with flat or minimal slope. Must incorporate perimeter edge restraint. Must use in-situ infiltration measurements. Must have minimum 2"/hr infiltration rate through the entire system. SHGWT at least 2 feet below bottom; recovery of treatment volume within 24 – 72 hours.
Key construction and maintenance considerations	Minimize soil compaction and sedimentation during construction; ensure design infiltration is met after construction; inspect during wet season to see if water is ponding and not infiltrating properly; use regular vacuum sweeping to minimize clogging and maintain infiltration capacity as needed to meet permit requirements; must maintain at least 2"/hr percolation rate; areas with high levels of wind-blown sediments (e.g., near the beach) may create maintenance issues.

4.6.2. Applicability

Pervious pavement systems can be used for many impervious applications (i.e., sidewalks, driveways, on-street parking) but they primarily are used in parking lots, especially the parking stalls. Typically, pervious pavements are used in areas with low-traffic volume, low truck traffic, and low number of turning areas. To address these concerns, pervious pavements often are integrated with traditional impervious pavements such as within a parking lot where the parking stalls are pervious pavements. The designer must consider the limitations of the pervious pavement system application in determining its proper application. In addition, the designer must consider various site conditions and potential challenges including:

- (a) Poorly draining soils such as those with shallow Seasonal High Ground Water Tables (SHGWTs), shallow confining units (i.e., clays/hardpans), organic mucks, etc.
- (b) In areas subject to high traffic volumes, regardless of wheel loads. It is recommended that:
 - 1. The number of vehicles using a pervious pavement parking stall should not exceed one hundred (100) vehicles per day for most pervious pavement systems.
 - 2. Traditional Class I concrete, brick pavers or an appropriate asphalt section should be used in areas subject to high traffic volumes such as the primary driving areas within a parking lot.
- (c) Regardless of wheel loads, pervious pavement should not be used on areas of frequent turning movements (public roadways, drive thru lanes, around gas pumps, adjacent to dumpster pads, driveway entrances, etc.). It is recommended that traditional Class I concrete, brick pavers or an appropriate asphalt section be used in these areas.
- (d) If pervious pavement is proposed for areas with heavy wheel loads or other non-recommended conditions, then the applicant will be required to use alternate methods of pavement design. This may include using imported (hydraulically clean) soils, structural/permeable geo-fabrics, thicker pervious pavement sections, etc. above the parent soil. Hydraulically clean soils will be defined as those that are free of materials (clays, organics, etc.) that will impede the soil's saturated vertical and horizontal hydraulic conductivity.
- (e) Pervious pavements will not be used in areas with high potential for hazardous material spills that could seep into the underlying ground water. Examples of these areas include (but are not limited to) gas stations, auto maintenance facilities, auto parts stores that are subject to on-site installation of hazardous materials by customers/store personnel, chemical plants, etc.
- (f) Pervious pavements may not be appropriate in areas with high levels of wind-blown sediment since these could increase maintenance.
- (f) Certain pervious pavement systems may create the potential for tripping hazards that needs to be considered when designing areas used by pedestrians or the handicapped.
- (g) Any underground treatment systems should not be located directly under pervious pavement.

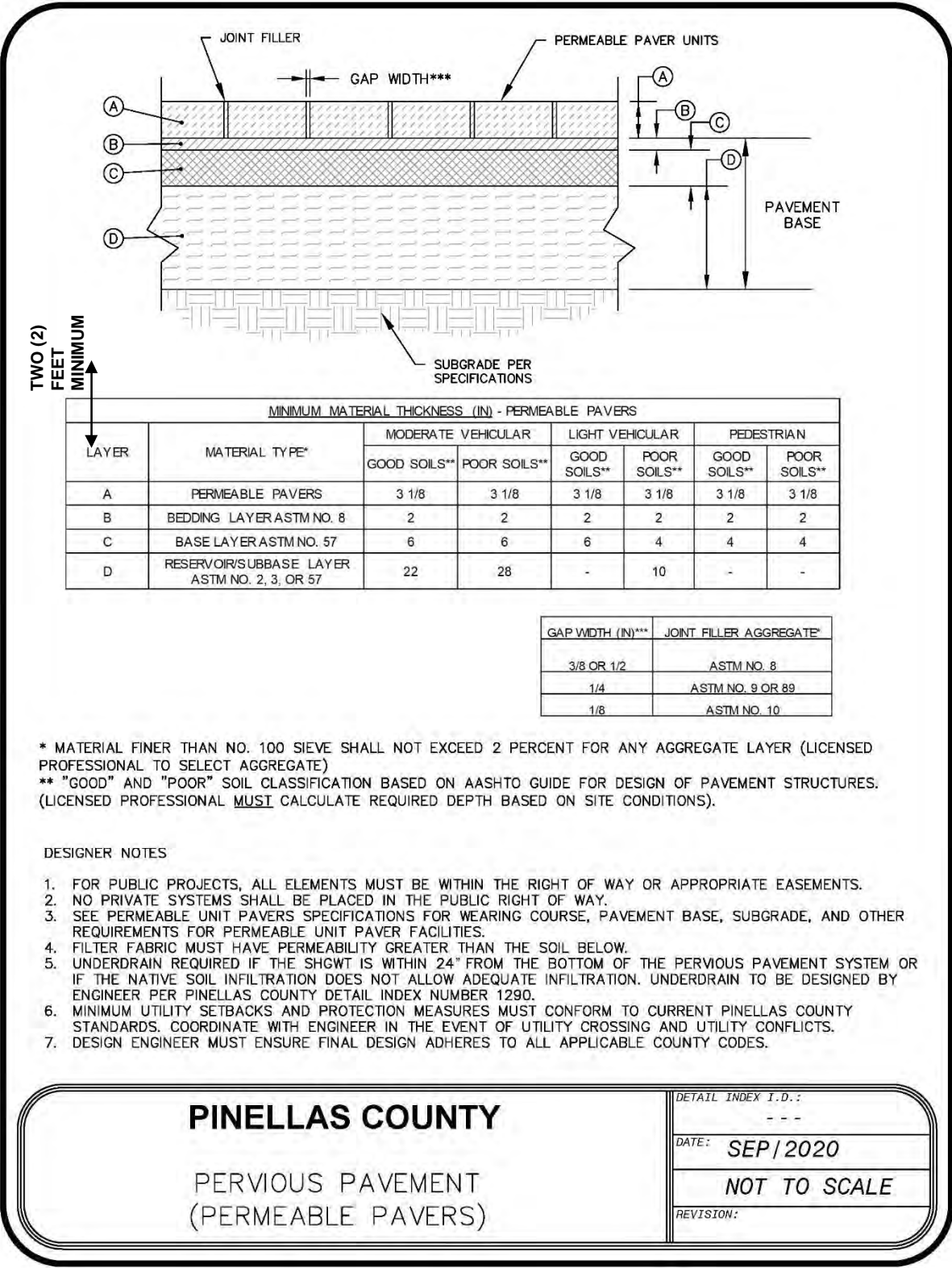

* MATERIAL FINER THAN NO. 100 SIEVE SHALL NOT EXCEED 2 PERCENT FOR ANY AGGREGATE LAYER (LICENSED PROFESSIONAL TO SELECT AGGREGATE)
 ** "GOOD" AND "POOR" SOIL CLASSIFICATION BASED ON AASHTO GUIDE FOR DESIGN OF PAVEMENT STRUCTURES. (LICENSED PROFESSIONAL MUST CALCULATE REQUIRED DEPTH BASED ON SITE CONDITIONS).

DESIGNER NOTES

- FOR PUBLIC PROJECTS, ALL ELEMENTS MUST BE WITHIN THE RIGHT OF WAY OR APPROPRIATE EASEMENTS.
- NO PRIVATE SYSTEMS SHALL BE PLACED IN THE PUBLIC RIGHT OF WAY.
- SEE PERMEABLE UNIT PAVERS SPECIFICATIONS FOR WEARING COURSE, PAVEMENT BASE, SUBGRADE, AND OTHER REQUIREMENTS FOR PERMEABLE UNIT PAVEMENT FACILITIES.
- FILTER FABRIC MUST HAVE PERMEABILITY GREATER THAN THE SOIL BELOW.
- UNDERDRAIN REQUIRED IF THE SHGW IS WITHIN 24" FROM THE BOTTOM OF THE PERVIOUS PAVEMENT SYSTEM OR IF THE NATIVE SOIL INFILTRATION DOES NOT ALLOW ADEQUATE INFILTRATION. UNDERDRAIN TO BE DESIGNED BY ENGINEER PER PINELLAS COUNTY DETAIL INDEX NUMBER 1290.
- MINIMUM UTILITY SETBACKS AND PROTECTION MEASURES MUST CONFORM TO CURRENT PINELLAS COUNTY STANDARDS. COORDINATE WITH ENGINEER IN THE EVENT OF UTILITY CROSSING AND UTILITY CONFLICTS.
- DESIGN ENGINEER MUST ENSURE FINAL DESIGN ADHERES TO ALL APPLICABLE COUNTY CODES.

PINELLAS COUNTY

PERVIOUS PAVEMENT
(PERMEABLE PAVERS)

DETAIL INDEX I.D.:	---
DATE:	SEP/2020
	NOT TO SCALE
REVISION:	

FIGURE 4.6.1. Pinellas County CAD template for Permeable Pavers

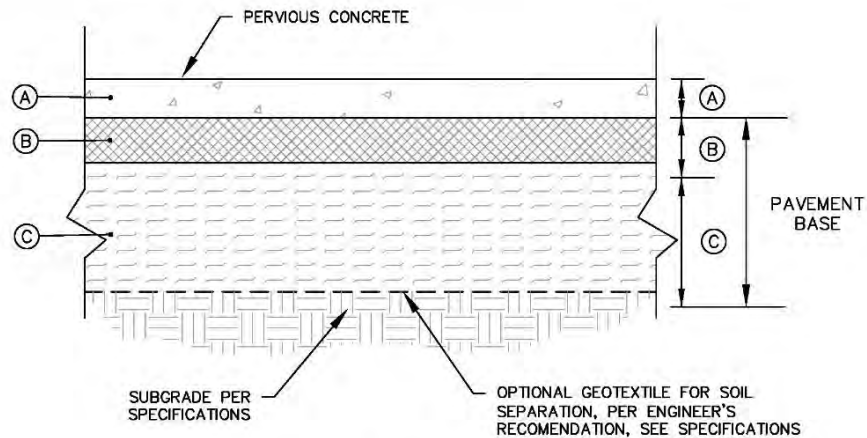

MINIMUM MATERIAL THICKNESS (IN) - PERVIOUS CONCRETE							
LAYER	MATERIAL TYPE*	MODERATE VEHICULAR		LIGHT VEHICULAR		PEDESTRIAN	
		GOOD SOILS**	POOR SOILS**	GOOD SOILS**	POOR SOILS**	GOOD SOILS**	POOR SOILS**
A	PERVIOUS CONCRETE LAYER	9	9 1/2	6 1/2	7	4	5
B	BEDDING LAYER ASTM NO. 8	6	6	6	6	6	6
C	OPTIONAL RESERVOIR/SUBBASE LAYER ASTM NO. 2, 3, OR 57	-	-	-	-	-	-

* MATERIAL FINER THAN NO. 100 SIEVE SHALL NOT EXCEED 2 PERCENT FOR ANY AGGREGATE LAYER (LICENSED PROFESSIONAL TO SELECT AGGREGATE)

** "GOOD" AND "POOR" SOIL CLASSIFICATION BASED ON AASHTO GUIDE FOR DESIGN OF PAVEMENT STRUCTURES. (LICENSED PROFESSIONAL MUST CALCULATE REQUIRED DEPTH BASED ON SITE CONDITIONS).

DESIGNER NOTES

1. FOR PUBLIC PROJECTS, ALL ELEMENTS MUST BE WITHIN THE RIGHT OF WAY OR APPROPRIATE EASEMENTS.
2. NO PRIVATE SYSTEMS SHALL BE PLACED IN THE PUBLIC RIGHT OF WAY.
3. SEE PERVIOUS CONCRETE SPECIFICATIONS FOR WEARING COURSE, PAVEMENT BASE, SUBGRADE, AND OTHER REQUIREMENTS FOR PERVIOUS CONCRETE FACILITIES.
4. FILTER FABRIC MUST HAVE PERMEABILITY GREATER THAN THE SOIL BELOW.
5. UNDERDRAIN REQUIRED IF THE SHGWTS IS WITHIN 24" FROM THE BOTTOM OF THE PERVIOUS PAVEMENT SYSTEM OR IF THE NATIVE SOIL INFILTRATION DOES NOT ALLOW ADEQUATE INFILTRATION. UNDERDRAIN TO BE DESIGNED BY ENGINEER PER PINELLAS COUNTY DETAIL INDEX NUMBER 1290.
6. MINIMUM UTILITY SETBACKS AND PROTECTION MEASURES MUST CONFORM TO CURRENT PINELLAS COUNTY STANDARDS. COORDINATE WITH ENGINEER IN THE EVENT OF UTILITY CROSSING AND UTILITY CONFLICTS.
7. DESIGN ENGINEER MUST ENSURE FINAL DESIGN ADHERES TO ALL APPLICABLE COUNTY CODES.

PINELLAS COUNTY
 PERVIOUS PAVEMENT
 (PERMEABLE CONCRETE)

DETAIL INDEX I.D.:

DATE: SEP/2020

NOT TO SCALE

REVISION:

FIGURE 4.6.2: Pinellas County CAD template for pervious concrete

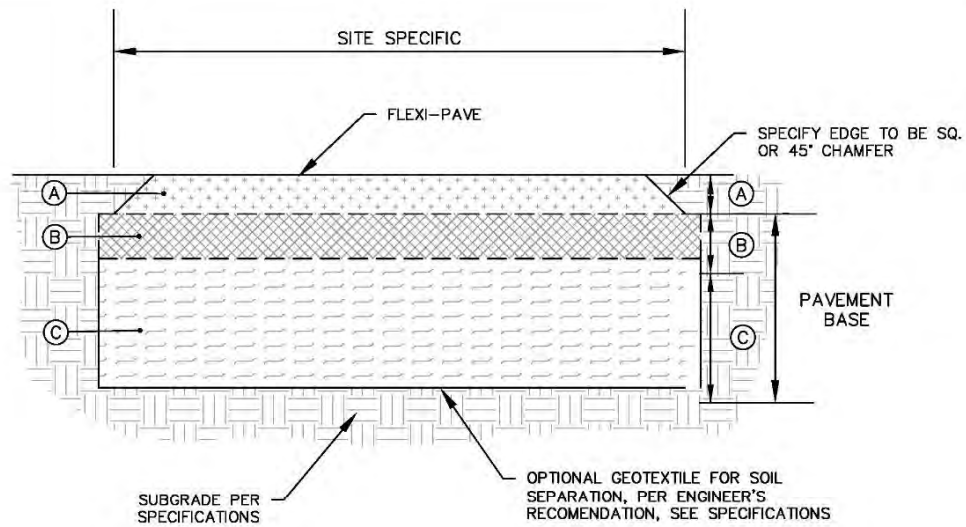

MINIMUM MATERIAL THICKNESS (IN) - FLEXI-PAVE

LAYER	MATERIAL TYPE*	PEDESTRIAN		LIGHT VEHICULAR	
		GOOD SOILS**	POOR SOILS**	GOOD SOILS**	POOR SOILS**
A	FLEXI-PAVE LAYER	1.5	1.5	1.5	1.5
B	BEDDING LAYER ASTM NO. 51 STONE 96% COMPACTION	4	4	4	4
C	OPTIONAL RESERVOIR/SUBBASE LAYER ASTM NO. 57 STONE	-	-	-	-

* MATERIAL FINER THAN NO. 100 SIEVE SHALL NOT EXCEED 2 PERCENT FOR ANY AGGREGATE LAYER (LICENSED PROFESSIONAL TO SELECT AGGREGATE)

** "GOOD" AND "POOR" SOIL CLASSIFICATION BASED ON AASHTO GUIDE FOR DESIGN OF PAVEMENT STRUCTURES. (LICENSED PROFESSIONAL MUST CALCULATE REQUIRED DEPTH BASED ON SITE CONDITIONS).

DESIGNER NOTES

1. FOR PUBLIC PROJECTS, ALL ELEMENTS MUST BE WITHIN THE RIGHT OF WAY OR APPROPRIATE EASEMENTS.
2. NO PRIVATE SYSTEMS SHALL BE PLACED IN THE PUBLIC RIGHT OF WAY.
3. SEE FLEXI-PAVE SPECIFICATIONS FOR WEARING COURSE, PAVEMENT BASE, SUBGRADE, AND OTHER REQUIREMENTS FOR PERVIOUS CONCRETE FACILITIES.
4. FILTER FABRIC MUST HAVE PERMEABILITY GREATER THAN THE SOIL BELOW.
5. UNDERDRAIN REQUIRED IF THE SHGWT IS WITHIN 24" FROM THE BOTTOM OF THE PERVIOUS PAVEMENT SYSTEM OR IF THE NATIVE SOIL INFILTRATION DOES NOT ALLOW ADEQUATE INFILTRATION. UNDERDRAIN TO BE DESIGNED BY ENGINEER PER PINELLAS COUNTY DETAIL INDEX NUMBER 1290.
6. MINIMUM UTILITY SETBACKS AND PROTECTION MEASURES MUST CONFORM TO CURRENT PINELLAS COUNTY STANDARDS. COORDINATE WITH ENGINEER IN THE EVENT OF UTILITY CROSSING AND UTILITY CONFLICTS.
7. DESIGN ENGINEER MUST ENSURE FINAL DESIGN ADHERES TO ALL APPLICABLE COUNTY CODES.

PINELLAS COUNTY

**PERVIOUS PAVEMENT
(FLEXI-PAVE)**

DETAIL INDEX I.D.:

DATE: **SEP/2020**

NOT TO SCALE

REVISION:

FIGURE 4.6.3.: Pinellas County CAD template for Flexi-Pave™

4.6.3. Required Treatment Volume

The treatment volume necessary to achieve the required treatment efficiency will be routed to the pervious pavement system and percolated into the ground. The required nutrient load reduction is set forth in the performance standards in **Section 3.1.1** of this Manual.

Treatment volumes to achieve the necessary efficiencies will be determined based on the percentage of directly connected impervious area (DCIA) and the weighted curve number for non-DCIA areas as set forth in Table 6.10.4 and Table 6.10.5.

4.6.4. Calculating Load Reduction Efficiency for a Given Retention Volume

Use **Table 6.10.4** to determine the treatment volume needed to achieve the presumptive 80% pollutant load reduction



If pervious pavements are being used in a BMP treatment train to achieve part of the required pollutant load reduction use **Table 6.10.5** to determine the percent reduction associated with various treatment volumes. Also use Table 6.10.5 to determine the treatment volume associated with the required nutrient load reduction to achieve the performance standard of reducing nutrient loads by at least 10% from current discharges.

4.6.5. Design Criteria

Pervious pavement system design has two major components: structural and hydraulic. The pervious pavement system must be able to support the traffic loading while also (and equally important) functioning properly hydraulically. This section does NOT discuss structural designs of pervious pavement systems. Stormwater permit applicants (and their engineering consultants) should consult the product manufacturer's pavement design standards to ensure that pervious pavements will be structurally stable, and not be subject to premature deterioration failure.

Below are the types of practices, specifications, recommendations, tools and potential conditions for applicants to consider for the approval of pervious pavement systems. This is not intended to cover all potential designs. Professional judgment must be used in the design and review of proposed pervious pavement systems.

- (a) Pervious pavement systems must have the capacity to retain the required treatment volume without a discharge and without considering soil storage.
- (b) The applicant must provide reasonable assurances that the pervious pavement construction will be performed by a contractor trained and certified by the product manufacturer to install the proposed pervious pavement system. To accomplish this requirement, the applicant must supply documentation of the appropriate contractor certification as part of the site plan process. If the pervious pavement contractor is not known at the time of site plan submittal, a special condition will be placed in the site plan approval to require submittal of the contractor's certification prior to construction commencement.
- (c) The seasonal high ground water table will be at least two feet beneath the bottom of the pervious pavement system unless the applicant demonstrates, based on plans, test results, calculations or other information, that an alternative design is appropriate for the specific site conditions. The "system" is defined as the pervious pavement itself, the underlying storage reservoir, if used (i.e., pea rock, #57 stone, etc.), and the geo-fabric that wraps the underlying storage reservoir (refer to Figures 4.6.1 through 4.6.3 for additional information). In areas where the SHGWT is within two feet of the bottom of the pervious pavement system, an underdrain shall be used.
- (d) The pervious pavement system must provide the capacity for the recovery of the required treatment volume of stormwater within 72 hours, with a safety factor of two, assuming average Antecedent Runoff Condition (ARC 2). In a pervious pavement system, the stormwater is drawn down by natural soil

infiltration and dissipation into the ground water table, as opposed to underdrain systems which rely on artificial methods like perforated or slotted stormwater pipes. A drawdown or recovery analysis is required that accounts for the mounding of ground water beneath the pervious pavement system. Details related to safety factors, recovery/mounding analysis and supporting soil testing are provided in Appendix A of this Manual.

- (e) The minimum vertical hydraulic conductivity of the pervious pavement system will not be less than 2.0 inches per hour. The percolation rate of the subgrade soils can be as low as 0.5 inch/hour when the pervious pavement system includes a reservoir of at least 6 inches of rock below the pavement,
- (f) Pervious pavement systems will not be constructed within 50 feet of a public or private potable water supply well or within 15 feet of an onsite wastewater disposal and treatment system.
- (g) The in-situ (or imported) subgrade soil (soil below the pervious pavement system) will be compacted to a maximum of 92% - 95% Modified Proctor density (ASTM D-1557) to a minimum depth of 24 inches. For proposed pervious pavements within redevelopment projects, the existing pavement section and its compacted base will be removed. The underlying soils are to be scarified to a minimum 16-inch depth, re-graded, filled with hydraulically clean soils (if applicable) and proof rolled to a maximum compaction of 92% - 95% Modified Proctor density (ASTM D-1557). For systems with a reservoir that is at least 6 inches of rock below the pavement the soils in the subgrade must have a percolation rate of at least 0.5 inch/hour. The reservoir acts as a buffer on the infiltration rate and stores about 1.5 inches of runoff.
- (h) Other than pedestrian walks, bicycle paths and driveway ingress or egress areas, the maximum slope for pervious pavements is 1/8 inch per foot (1.04%) although zero % slope is preferred. Steeper slopes (greater than 1/8 inch per foot) will be considered by the County but must be justified by the applicant as part of the site plan review process by providing plans, monitoring data, test results, or other information that demonstrates that the steeper slopes are appropriate for the specific site conditions and provides equivalent treatment and protection. The primary issue of concern is the hydraulic ability of the pervious pavement system to percolate the Required Treatment Volume (RTV) into the underlying sub-soil.
- (i) Except for pervious walks and bike paths, curbing, edge constraint or other equivalent hydraulic barrier will be required around the pervious pavement to a minimum depth of eight (8) inches beneath the bottom of the pavement and to the depth necessary to prevent scouring from the horizontal movement of water below the pavement surface depending on the adjacent slopes. Refer to Figures 4.6.1 through 4.6.4 for additional information. Another option is to create check dams within the aggregate reservoir that will reduce runoff velocity and the potential for scour.

The horizontal movement of water can cause scour failure at the edge of the pervious pavement system or mask the hydraulic failure of the system due to plugging of the deeper voids in the pervious pavement or aggregate reservoir. The cross-sectional construction drawings of the pervious pavement system and its relationship to the slopes of adjacent areas must include a demonstration that the depth of the curbing, edge constraint or other equivalent hydraulic barrier is sufficient to prevent erosion and scour. As an option, the delineated areas of nuisance ponding can be shown on the supporting stormwater application sketches or drawings.

To minimize scour, the velocity of flow at the flood control design condition will be between 2 and 5 feet per second.

- (j) To provide an indicator that the pervious pavement system has failed or needs maintenance, the system will be designed to allow a minimum ponding depth of one inch and a maximum ponding depth of two inches prior to down-gradient discharge with the exception of pervious walks and bicycle paths (see Figures 4.6.1 through 4.6.4). The permitted construction plans will delineate the areas of pervious

pavement that may be subject to nuisance ponding. As an option, the delineated areas of nuisance ponding can be shown on the supporting ERP application sketches or drawings.

- (k) The pervious pavement system must be designed to have an overflow at the nuisance ponding elevation to the down-gradient stormwater treatment or attenuation system or outfall (see Figures 4.6.1 through 4.6.6).
- (l) Erosion and sediment controls on adjacent landscaped areas must be kept in place until all of the contributing area is stabilized. Runoff from adjacent landscaped areas must NOT be directed onto pervious pavement system areas unless the Applicant demonstrates that the offsite areas that drain onto the pervious pavement will not increase sediment, silt, sand, or organic debris that increases the potential for clogging the pervious pavement. The design must minimize the likelihood of silts and sands from plugging the pavement void spaces (see Figures 4.6.9 through 4.6.11).
- (m) With the exception of pervious walks and bicycle paths, the installation of Embedded Ring Infiltrometer Kit (ERIK) is required (see Figures 4.6.7 and 4.6.8). A minimum one ERIK in-situ infiltrometer will be required for each section of pervious pavement installed. For larger sections, (greater than one acre) a minimum of two in-situ ERIK infiltrometers per acre of pervious pavement will be required. ERIK Infiltrometers will be placed in the lowest part of the pervious parking area where ponding will occur if the pavement fails to infiltrate properly. The location of the ERIK infiltrometers will be shown on the construction plans or other supporting sketches or drawings for the project.
- (n) Documentation of ERIK infiltrometer construction, and post-construction testing, will be required with submittal of the construction completion certification. Test results will be provided in report form, certified by the appropriate Florida Registered Professional. The construction completion certification will not be accepted if the vertical hydraulic conductivity is less than 2.0 inches per hour or is less than the permitted design percolation rate in any of the required ERIK infiltrometers, as appropriate.
- (o) For proper maintenance of most pervious pavement systems, periodic vacuum sweeping is recommended. At a minimum, vacuum sweeping is required annually but frequency depends on traffic volume and runoff contributions from adjacent landscaping. If ERIK tests indicate a vertical hydraulic conductivity rate less than 2.0 inches per hour, or is less than the permitted design percolation rate, or when nuisance ponding occurs, vacuum sweeping is required. Vacuum sweeping is required for areas that are subject to wind transported soils (near sand dunes or other coastal areas) or other conditions where excessive soil or other debris deposition is expected to occur (from adjacent landscaping mulch and leaf litter, from areas with high leaf fall, fugitive sands and lime rock fines from adjacent construction sites).
- (p) A remediation plan will be submitted to the County for implementation by the permittee should vacuum sweeping fail to improve the vertical hydraulic conductivity to a rate greater than 2.0 inches per hour, or equal to or greater than the permitted design percolation rate or resolve the nuisance ponding. The remediation plan will be prepared and submitted to the County for review and approval. Maintenance records will be retained by the permittee and made available to the County as part of the required O&M re-inspections and certifications.
- (q) The entrances to pervious pavement areas will be posted by signs to inform users they are entering a pervious pavement area and that any vehicles with heavy wheel loads or with muddy tires should not enter.
- (r) Water quality credit for pervious pavement walks and bicycle paths:

For the purposes of this section, pervious pavement walks and bicycle paths refer to linear pathways and excludes areas such as courtyards and patio areas. To encourage the use of pervious pavement, the following credits are established for pervious pavement walks and bicycle paths:

1. For soils with SHGWT depths of 0" to 18" below the bottom of the pervious pavement system, 80% of the pervious pedestrian walk and bike path areas can be subtracted from the total contributing area when computing the project's required treatment volume.
2. For soils with SHGWT depths greater than 18" below the bottom of the pervious pavement system, 100% of the pervious pedestrian walk and bike path areas can be subtracted from the total contributing area when computing the project's required treatment volume.

To receive this credit, pervious walks and bicycle paths must be placed over native upland soils (excluding wetlands), appropriate clean fill, or soil media described in Section 4.12. For redevelopment projects, the pervious walks and paths must be placed over rehabilitated soils as described in (g) above.

For walks and paths that are properly designed and constructed pursuant to these design criteria, vacuum sweeping, remediation plans and ongoing O&M re-inspections and certifications will not (normally) be required.

4.6.6. Required Site Information

Successful design of a pervious pavement system depends heavily upon conditions at the site, especially information about the soil, geology, and water table conditions. Specific data and analyses required for the design of a pervious pavement system are set forth in APPENDIX A of this Manual.

4.6.7. Construction requirements

The following construction procedures are required to assure that the pervious pavement is properly prepared and installed such that the desired infiltration rate is obtained:

- (a) The location and dimensions of the pervious pavement will be verified onsite prior to its construction. All design requirements including pervious pavement dimensions and distances to foundations, septic systems, and wells need to be verified.
- (b) The location of pervious pavement areas will be clearly marked at the site to prevent unnecessary vehicular traffic across the area causing soil compaction.
- (c) Excavation will be done by lightweight equipment to minimize soil compaction. Tracked, cleated equipment does less soil compaction than equipment with tires.
- (d) Once the subgrade elevation has been reached, the area will be inspected for materials that could puncture or tear the filter fabric, such as tree roots, and assure they are not present.
- (e) The in-situ (or imported) subgrade soil (soil below the pervious pavement system) will be compacted to a maximum of 92% - 95% Modified Proctor density (ASTM D-1557) to a minimum depth of 24 inches.
- (f) The specified filter fabric will be installed in accordance with the design specifications.
- (g) The aggregate material will be inspected prior to placement to ensure it meets size specifications and is washed to minimize fines and debris. It should be spread uniformly to the appropriate thickness.
- (h) The pervious pavement material will be installed by a contractor trained and certified by the product manufacturer to install the proposed pervious pavement system according to approved design specifications.

- (i) Stormwater will not be directed onto the pervious pavement from adjacent contributing areas until after they are stabilized to prevent sediment from entering and clogging the pervious pavement. All erosion and sediment controls will remain in place until the contributing watershed area is fully stabilized.
- (j) Before the pervious pavement is placed into operation, signs will be installed at all entrances advising users that they are entering a pervious pavement parking lot and that vehicles with heavy wheel loads or muddy tires should not enter.
- (k) An applicant may propose alternative construction procedures to assure that the design infiltration rate of the pervious pavement is met.

4.6.8. Inspection, Operation and Maintenance

Maintenance issues associated with pervious pavements are related to clogging of the porous surfaces which reduces or prevents infiltration thereby slowing recovery of the stormwater treatment volume and often resulting in standing water and the designed nuisance flooding.

To determine if the pervious pavement is properly functioning or whether it needs maintenance requires that either an inspection be within 72 hours of a storm and that the ERIK devices be used to test the infiltration rate as specified below.

(a) Inspection Items:

(1)	Inspect pervious pavement for storage volume recovery within the permitted time, generally less than 72 hours. Determine if nuisance flooding is occurring in those areas of the parking lot that were designed to flood if the pervious pavement was failing. Nuisance flooding indicates that the required treatment volume is not infiltrating because of a reduction of the infiltration rate and a need to restore system permeability.
(2)	Use the ERIK infiltrometers at least once every two years to test if the vertical hydraulic conductivity is less than 2.0 inches per hour or is less than the permitted design percolation rate in any of the required ERIK infiltrometers. If any of the ERIK infiltrometers have rates less than the permitted rate, maintenance activities will be undertaken to restore the permeability of the pervious pavement. The results of the ERIK infiltrometer testing will be submitted to the County if requested.
(3)	Inspect all edge constraints and overflow areas to determine if any erosion is occurring and repair as needed.

(b) Maintenance Activities As-Needed to Prolong Service:

(1)	Visual inspection of the permeable pavement to ensure that it is clean of debris and sediments, preferably following or during a storm event. Any signs of ponding would be an indication that it may be time for maintenance. Routine maintenance cleaning procedures would include using a vacuum style street sweeper. This will help prevent clogging by keeping sediment from embedding into the pavement's voids. This routine maintenance should be performed bi-annually to keep the entire pervious concrete area clog-free or whenever the vertical hydraulic conductivity is less than 2.0 inches per hour or is less than the permitted design percolation rate in any of the required ERIK infiltrometers.
-----	---

(2)	Over time the system may need a deep cleaning if not performing according to standards or if the vertical hydraulic conductivity is less than 2.0 inches per hour. Deep cleaning or unclogging is best accomplished by simultaneous pressure washing and vacuuming. Several equipment manufacturers have developed simultaneous pressure washing and vacuuming systems that have proven to rehabilitate the pore structure of pervious pavement.
(3)	Vacuum sweeping will be done on an as-needed basis on pervious pavements located in areas that are subject to wind transported soils (near sand dunes or other coastal areas) or other conditions where excessive soil or other debris deposition is expected to occur (from adjacent landscaping mulch and leaf litter, from areas with high leaf fall, fugitive sands and lime rock fines from adjacent construction sites, etc.). The construction of pervious or permeable pavement is not recommended close to beaches or sand dunes.
(4)	A maintenance log should be completed and maintained on-site detailing the date of maintenance, responsible entity, methods used, observations, and any recommendations.
(5)	A remediation plan will be submitted to the County should vacuum sweeping fail to improve the vertical hydraulic conductivity to a rate greater than 2.0 inches per hour, or equal to or greater than the permitted design percolation rate or resolve the nuisance ponding. The remediation plan will be prepared and submitted to the County for review and approval.
(6)	Repair erosion near edge constraints or overflows and assure that the contributing watershed area is stabilized and not a source of sediments.

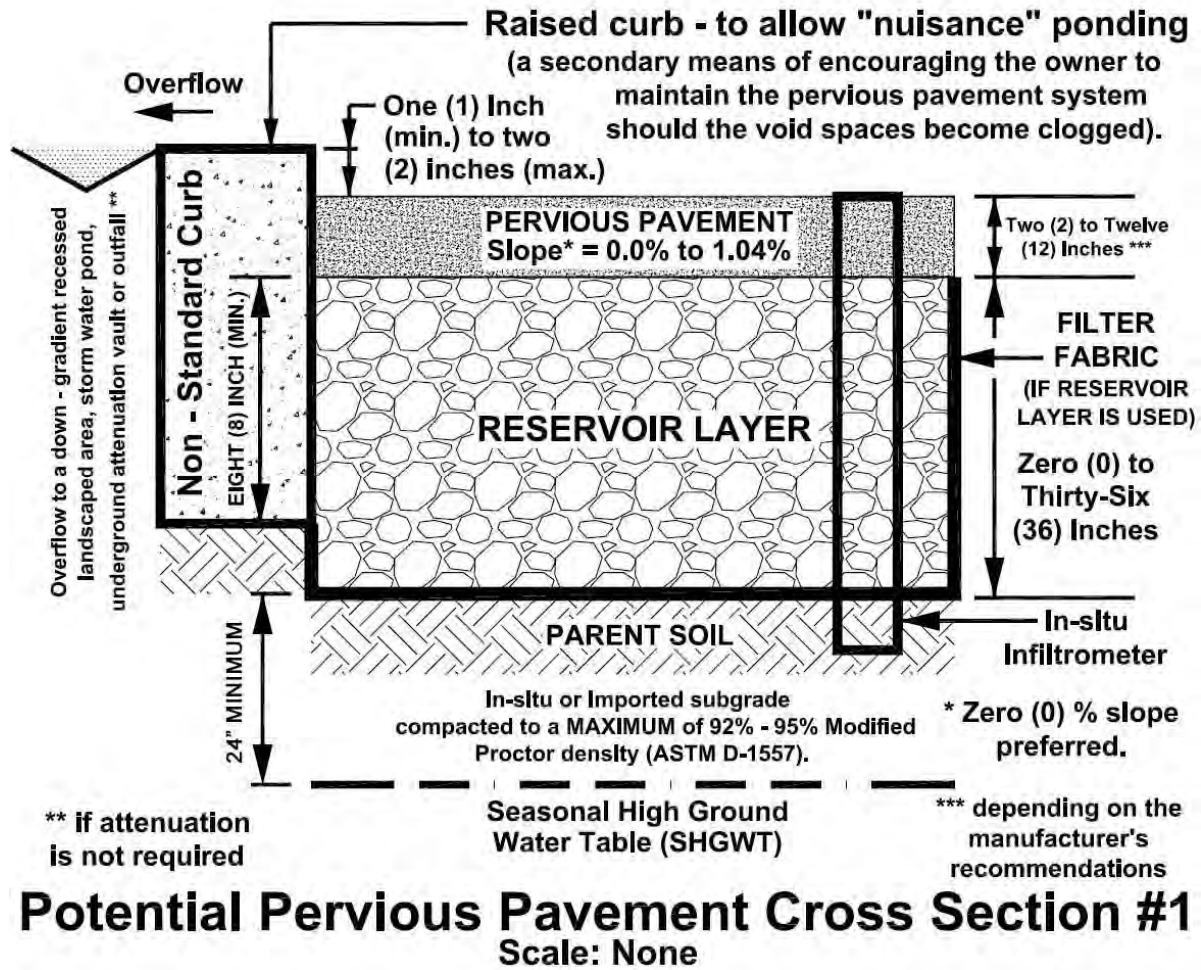
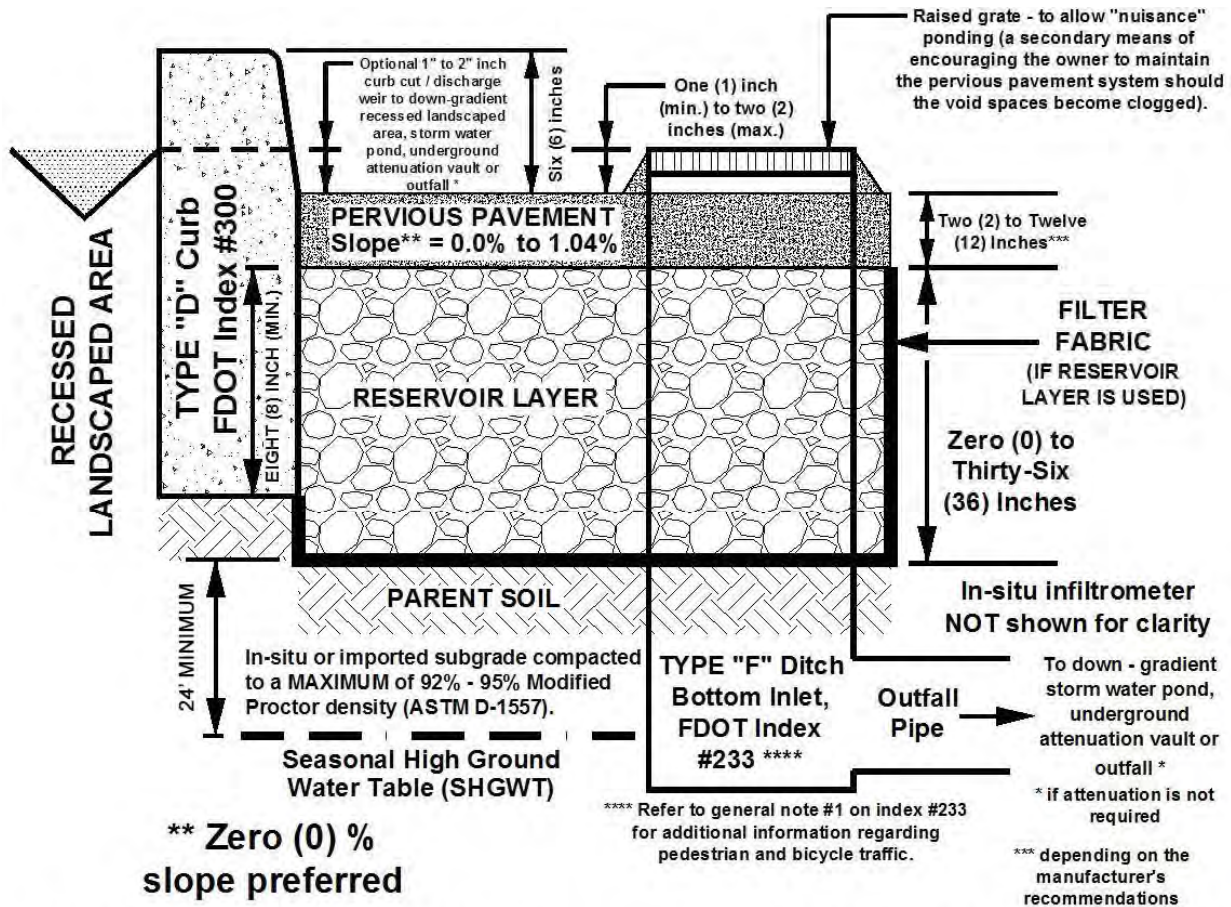

FIGURE 4.6.4. Pervious Pavement System Cross Section #1.



Potential Pervious Pavement Cross Section #2

Scale: None

FIGURE 4.6.5. Pervious Pavement System Cross Section #2.

Slope to center of Parking area to allow "nuisance" ponding *

As an option, a FDOT Type "F" DBI ** [with a one (1) to two (2) inch high raised grate] can be utilized to allow overflow to a down gradient storm water pond, underground attenuation vault or outfall ***

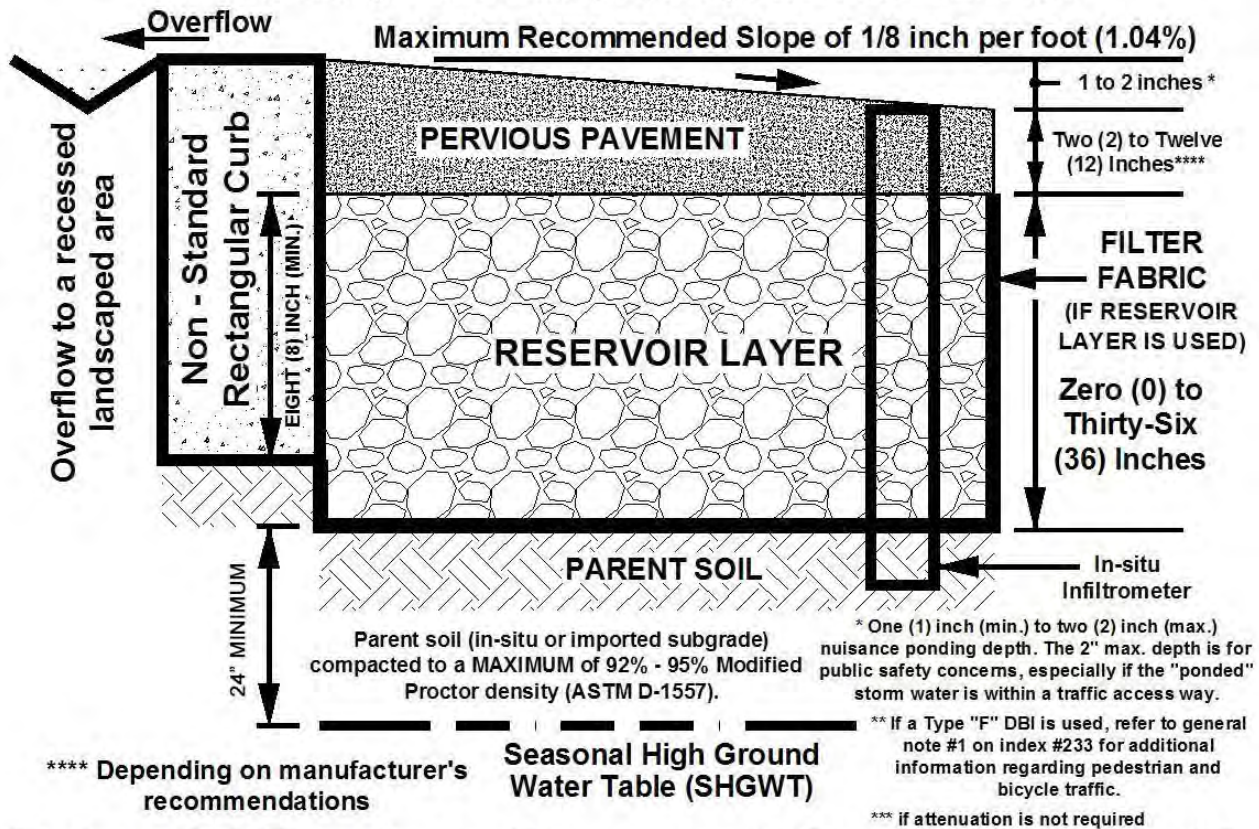

Potential Pervious Pavement Cross Section #3
Scale: None

FIGURE 4.6.6. Typical Pervious Pavement System Cross Section #3.

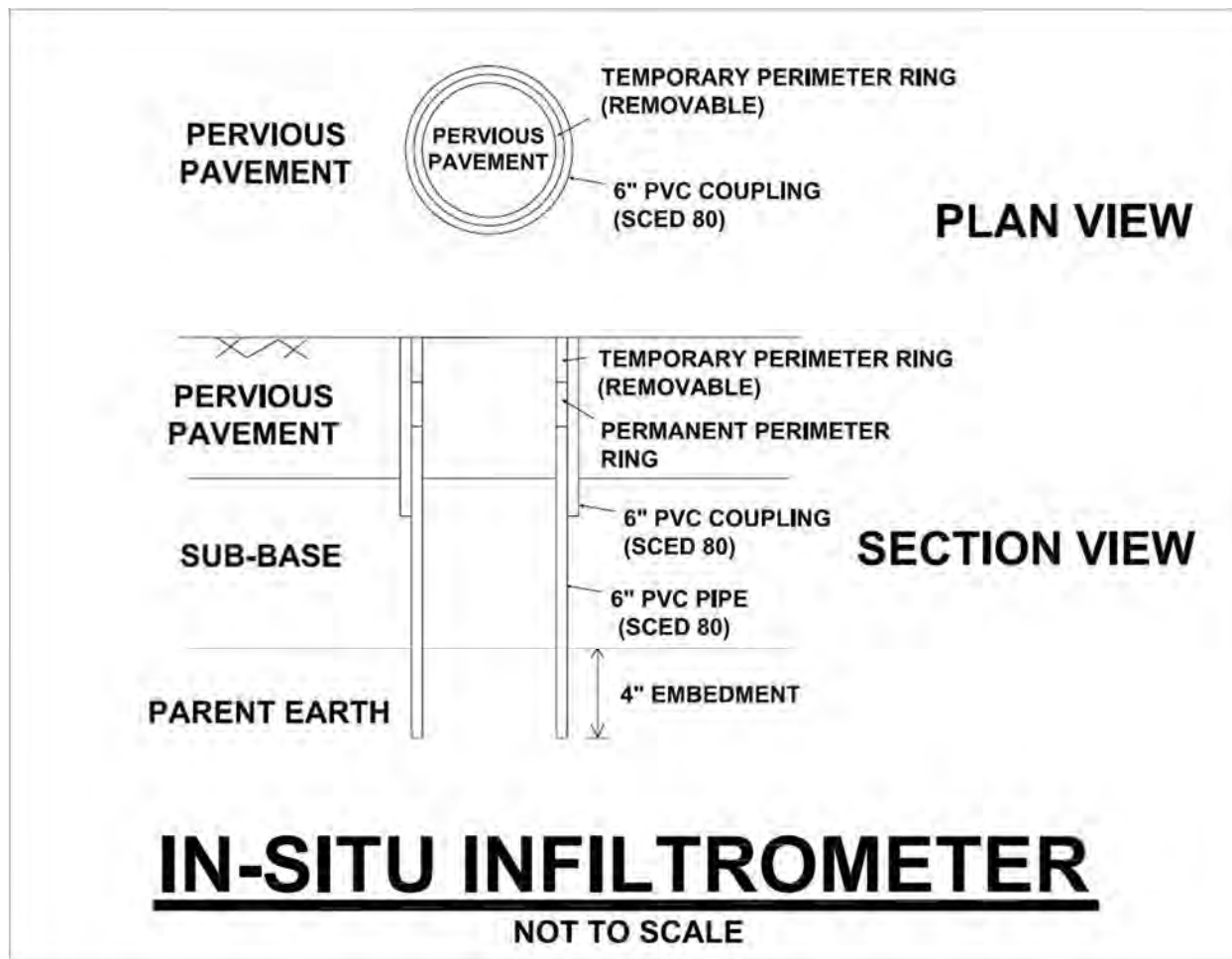

Figure 4.6.7. Plan View of ERIK In-Situ Infiltrometer - (Embedded Ring Infiltration Kit).

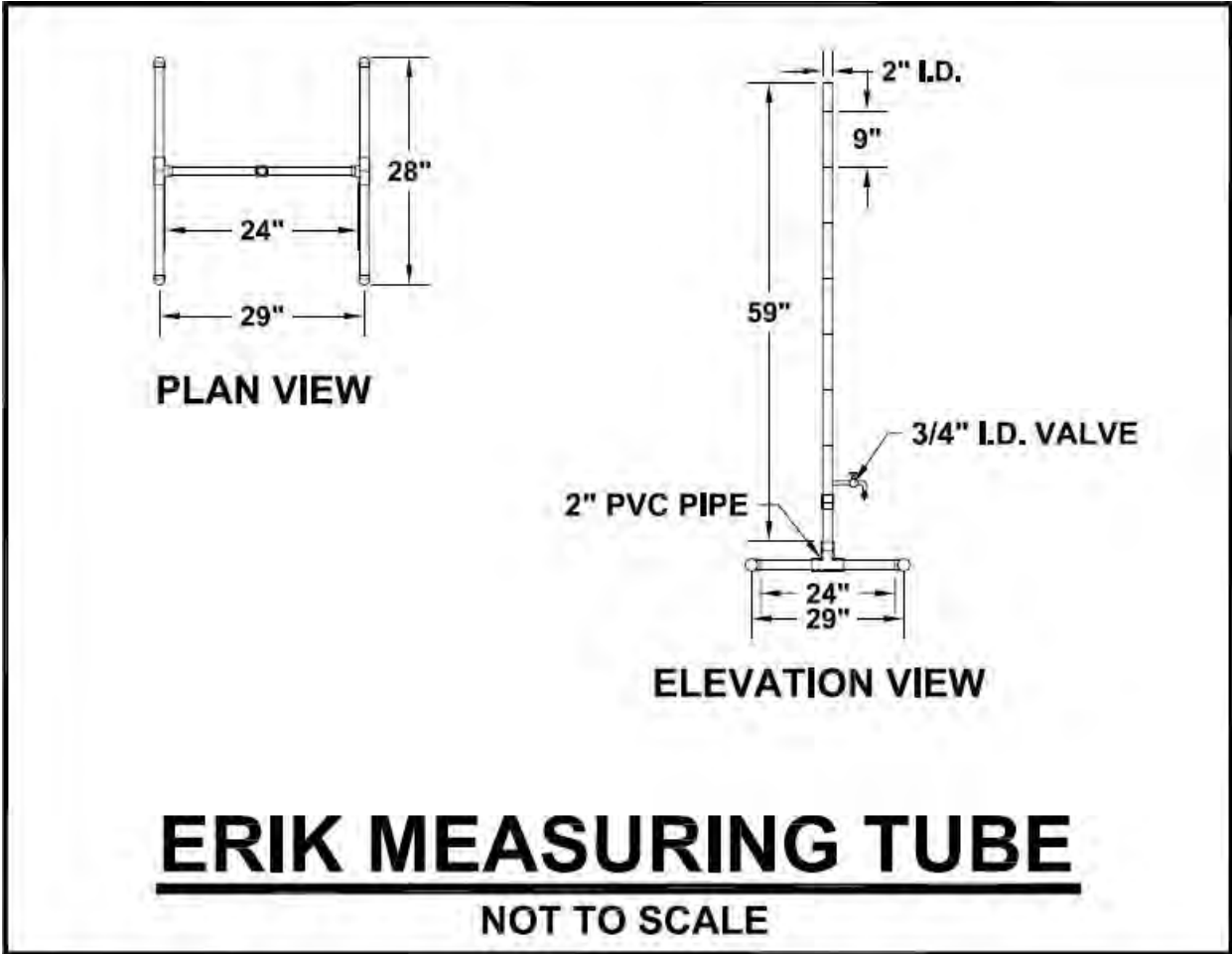

Figure 4.6.8. ERIK Measuring Tube.

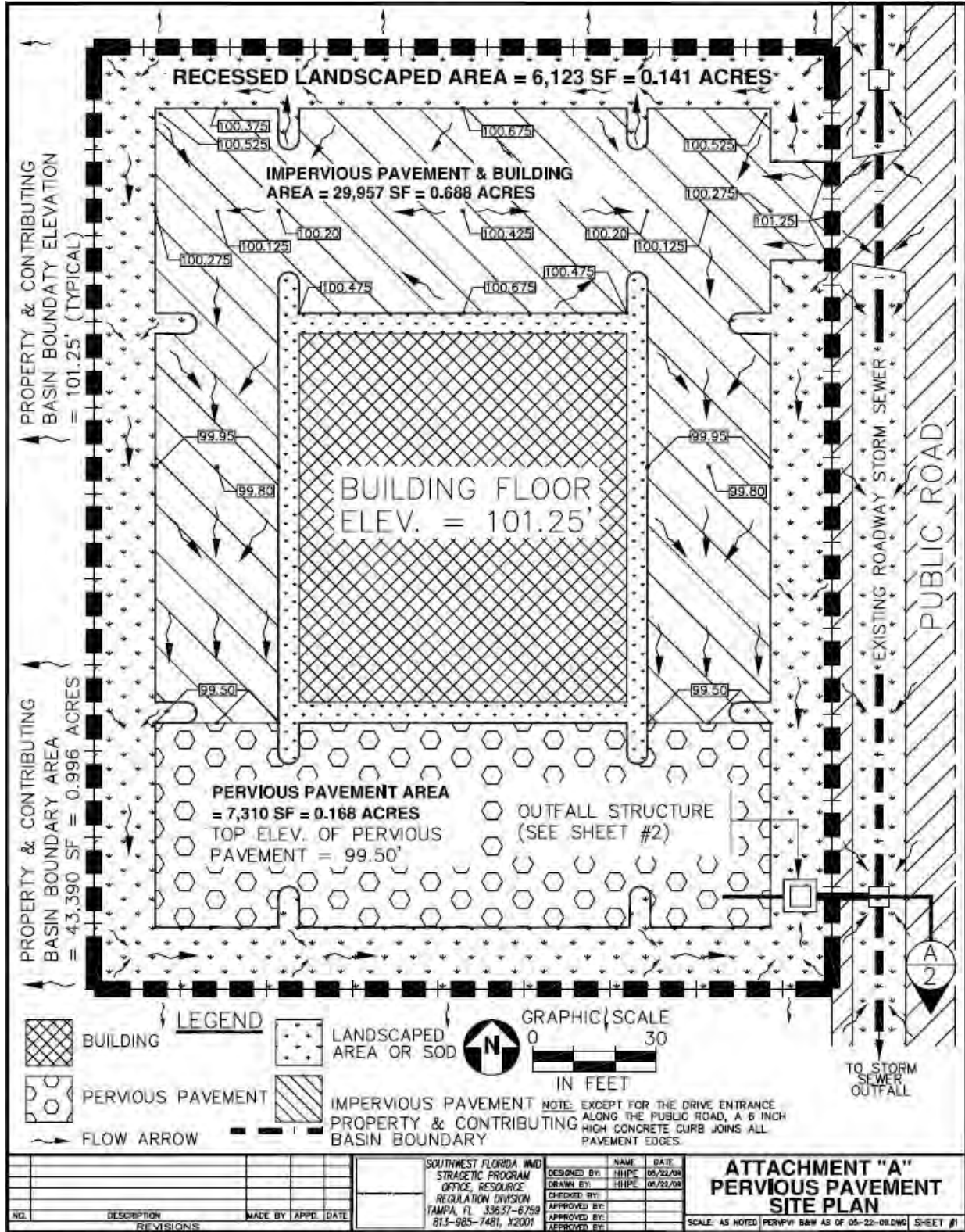

Figure 4.6.9. Pervious Pavement Site Plan.

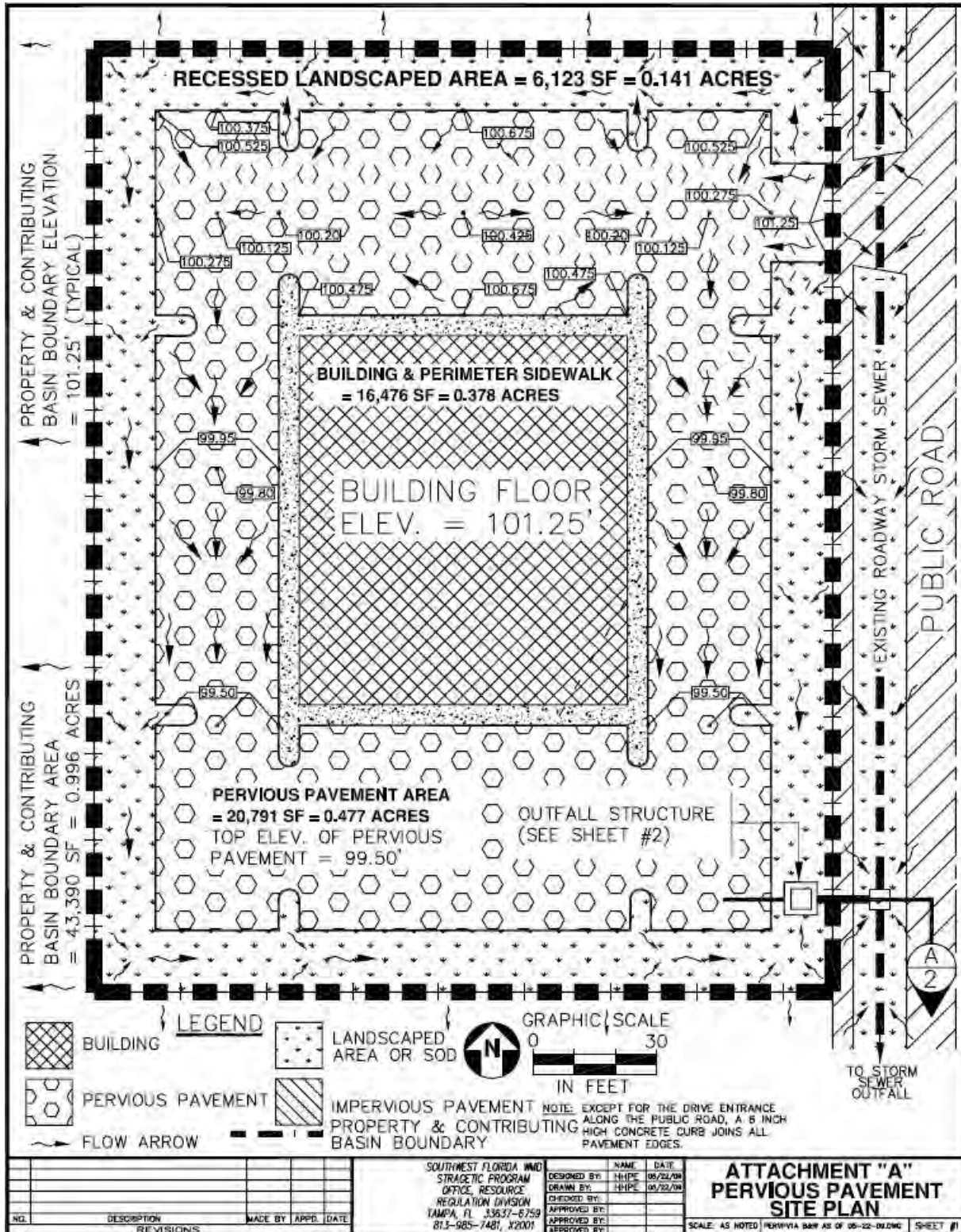

Figure 4.6.10. Pervious Pavement Site Plan.

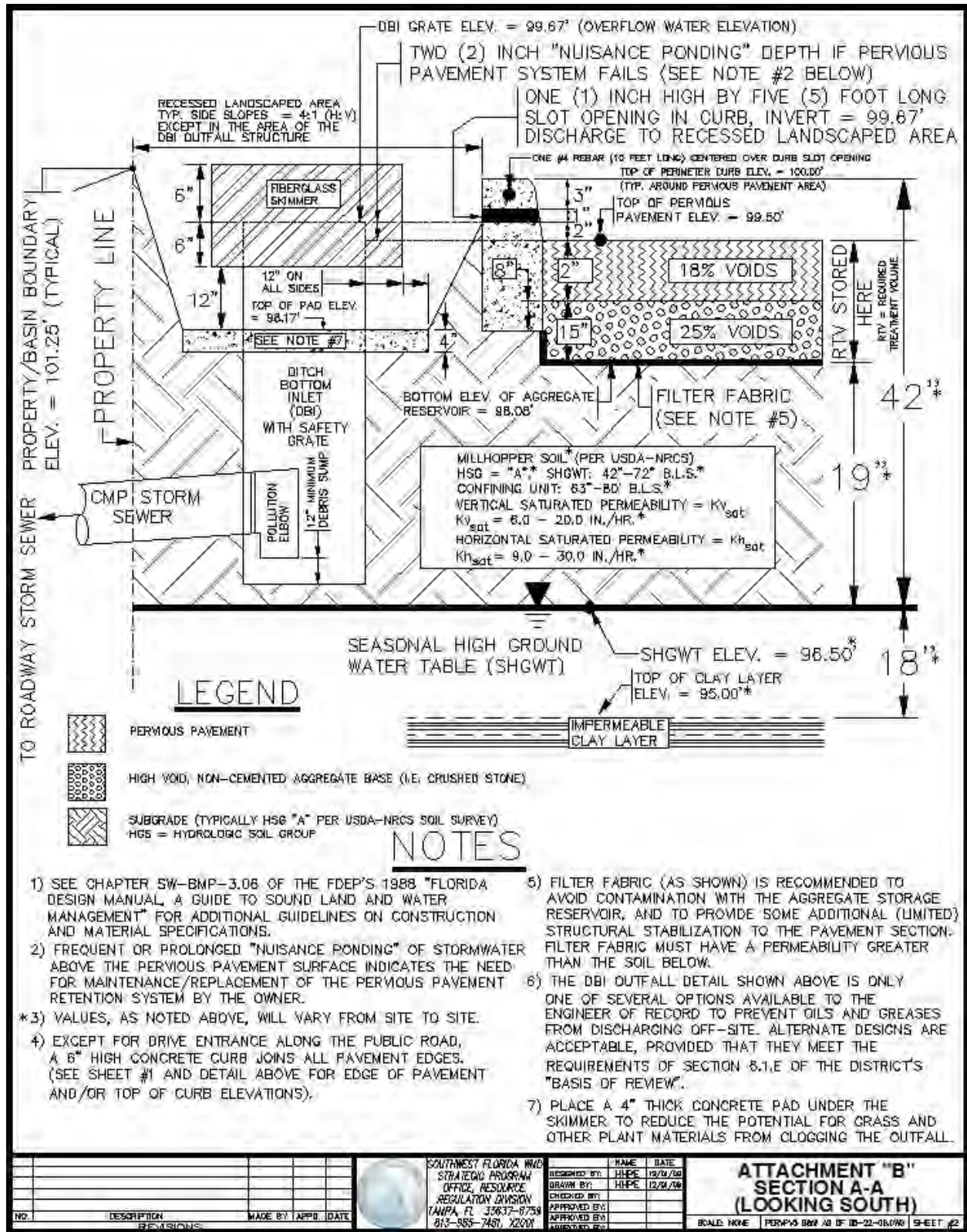

Figure 4.6.11. Pervious Pavement Site Plan

4.7. Green Roof/Cistern Systems

4.7.1. Description

A green roof/cistern stormwater treatment system is a vegetated roof followed by storage in a cistern for the filtrate that is reused for irrigation. A green roof/cistern system is a retention BMP and its effectiveness is directly related to the annual volume of roof runoff that is captured, retained, and reused. The filtrate from the green roof is collected in a cistern or other appropriate storage container or, if the green roof is part of a BMP Treatment Train, the filtrate may be discharged to a downstream BMP such as a wet detention pond. The cistern is sized for a specific amount of filtrate and receives no other runoff water. Other pond storage must also provide capacity to detain a specified quantity of filtrate. The retained water is used to irrigate the roof. Irrigation must be provided to maintain the plants. A back up source of water for irrigation is necessary. Excess filtrate and excess runoff can be discharged to other stormwater treatment systems, infiltrated into the ground, or used for irrigation or other non-potable purposes. The green roof/cistern system functions to attenuate, evaporate, and lower the volume of discharge and pollutant load coming from the roof surface. Greenroom systems have been shown to assist in stormwater management by attenuating hydrographs, neutralizing acid rain, reducing volume of discharge, and reducing the annual mass of pollutants discharged.

Concentrations of pollutants discharged from a green roof with pollution control media have been shown to be approximately the same as would be anticipated from a conventional roof. Thus, the concentration and mass must be managed. If no pollution control media are used, green roof concentrations are greater than those from conventional roofs. In addition, with fertilization of the plants, increased nutrients are expected and storage for the filtrate is required.

GREEN ROOF/CISTERN SUMMARY

Advantages/Benefits	Reduces site imperviousness, stormwater volume, peak discharge rate, pollutant loadings, temperature, and heat island effect. Increases thermal efficiency of roof. Increases efficiency of solar cells. Increases life of roof to over 50 years. Can be an aesthetic amenity or an area for gardening. Provides ground water recharge and water reuse. Increases development potential of site.
Disadvantages/Limitations	More expensive than traditional roofs and more difficult to install. Typically used on flat roofs. Must meet roof structural integrity.
Volume Reduction Potential	Moderate to High depending on roof area and storage volume.
Pollutant Removal Potential	Moderate to High for all pollutants.
Key design considerations	Must be located on building roof. Treatment system includes waterproofing layer, root barrier layer, drainage layer, pollution control layer, filter fabric, growth media layer and vegetation with irrigation and storage for green roof filtrate. Must have source of backup water supply. Must have minimum 2"/hr infiltration rate through the entire system. Recovery of treatment volume within 24 – 72 hours.
Key construction and maintenance considerations	Minimize soil compaction and sedimentation during construction; ensure design infiltration is met after construction; inspect during wet season to see if water is ponding and not infiltrating properly; use regular vacuum sweeping to minimize clogging and maintain infiltration capacity as needed to meet permit requirements; must maintain at least two inch/hr percolation rate; areas with high levels of wind-blown sediments (e.g., near the beach) may create maintenance issues.

4.7.2. Required Treatment Volume

The treatment volume necessary to achieve the required treatment efficiency will be captured by the green roof/cistern system and used for irrigation of the green roof plants or other landscaping. The required nutrient load reduction is set forth in the performance standards in **Section 3.1.1.** of this Manual.

Like all retention BMPs, the nutrient removal effectiveness is directly related to the annual volume of roof runoff that is retained and for green roofs that is the volume within the green roof/cistern system. However, this treatment method has an additional irrigation input some of which returns to the cistern. This requires the cistern to be larger than that required by retention without irrigation return. Nevertheless, the method can be used for nutrient load reduction.

Treatment volumes to achieve the necessary efficiencies will be determined based on the percentage of directly connected impervious area (DCIA) and the weighted curve number for non-DCIA areas as set forth in Table 6.10.4. and 6.10.5.

4.7.3. Calculating Load Reduction Efficiency for a Given Retention Volume

Use **Table 6.10.4.** to determine the treatment volume needed to achieve an 80% pollutant load reduction.



Generally, green roof will be used in a BMP treatment train to achieve part of the required pollutant load reduction so use **Table 6.10.5.** to determine the percent reduction associated with various treatment volumes. Also use **Table 6.10.5.** to determine the treatment volume associated with the required nutrient load reduction to achieve the performance standard of reducing nutrient loads by at least 10% from current discharges.

As an alternative, the design curves in Section 6.10.8. can be used to determine the treatment volume.

4.7.4. Classification of Green roof Surfaces

There are two types of green roofs described in this Manual. An extensive green roof is one where the root zone (pollution control layer and growth media layer) is less than 6 inches in depth. Whereas intensive green roofs have root zones greater than or equal to 6 inches and are typically intended for public or private access. There are two distinct functions for green roofs, one is passive and the other is active. Passive green roofs are intended only for maintenance access and typically require less maintenance, while an active roof is used for public and private access. Green roofs can be built on any type of roof deck with a minimum slope of one inch per foot if there is adequate structural support provided. Accordingly, as part of the application, a structural engineer must certify that the roof can safely handle the weight load of the green roof. There are several components that are required for green roofs as described in the following sections of this Manual. Figures 4.7.1a and 4.7.1b provide typical green roof details for the different types of roofs and various component details.

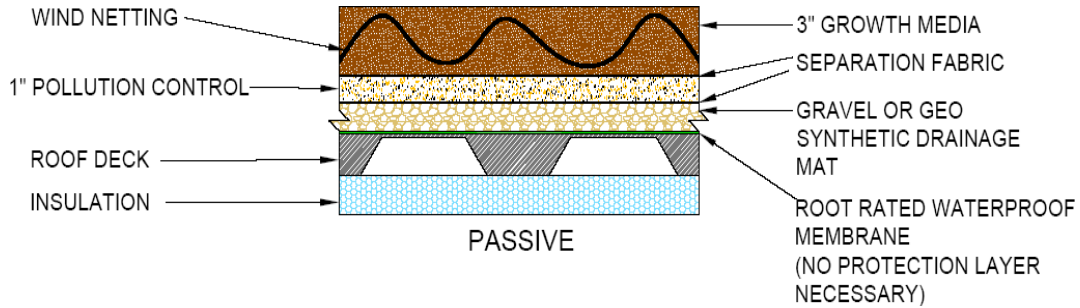

Figure 4.7.1a. Extensive Green roof Section (Usually Passive Function)

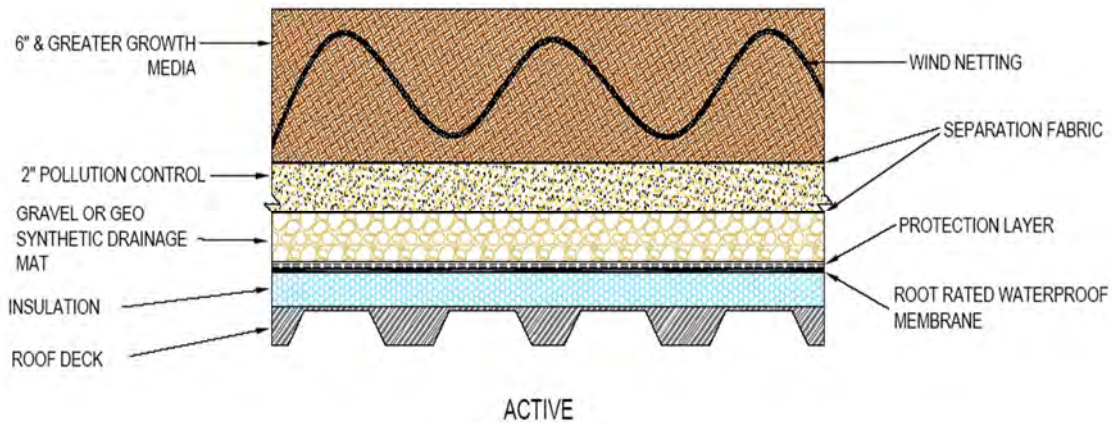

Figure 4.7.1b. Intensive Green roof Section (Usually Active Function)

4.7.5. Design Criteria

- (a) Green roof/cistern systems will be designed to capture and use the required treatment volume for irrigation without discharge except to downstream BMPs if used as part of a BMP treatment train.
- (b) **Structural Integrity** – a structural engineer must certify that the roof can support the weight load of the green roof system.
- (c) **Waterproof Membrane** - A waterproof membrane layer must be incorporated into the roof system to protect the structure from moisture damage. There are several options for this layer such as, polypropylene or polyethylene membrane, polyvinyl chloride, or spray applied elastomeric waterproofing membrane as well as others. The applicant must check with the membrane manufacturer to ensure that the membrane is rated as a root protection material. All permitted design specifications and manufacturer’s installation directions will be followed to ensure that the proposed product will function as intended with green roof overburden.
- (d) **Drainage Layer** - The major function of the drainage layer is to facilitate lateral movement of the filtrate to the point of drainage to ensure no standing water is present. The drainage layer can consist of several different materials such as gravel, recycled products, or geo-synthetic drainage mats. It is important to note that whatever material used will not depress or elevate the pH of the filtrate more than 1.5 pH units from neutral. When using aggregate as drainage layer materials, it must contain no more than 7% “fines”

(particles passing sieve number 200) by mass. The drainage material must be able to structurally support the intended green roof overburden, as well as maintenance activities, without deflection such that drainage is blocked or restricted. A non-woven geotextile separation fabric must be installed on top of the drainage layer to prevent clogging of the drainage layer. This fabric will have a thickness to pass the drainage water and void spaces such that the pollution control media does not fill the surface void area of the drainage layer and cause clogging. The hydraulic conductivity of the fabric must exceed 1.5 inches per hour.

(e) **Pollution Control Media** - Green roofs used for stormwater treatment credit must use a pollution control media layer. The pollution control layer is at least 1 inch in depth. This layer is to include materials known to adsorb pollutants such as phosphorus, nitrogen, metals or other pollutants of concern for the installation site. Pollution control media will meet all of the following specifications.

- All soil media mixes must display no acute toxicity at the applied media mix.
- Unit Weight is no more than 45 pounds per cubic foot when dry.
- No more than five percent of the particles passing the #200 sieve.
- Over 50 percent mineral by volume and contains no shale.
- At least one inch in thickness.
- Water holding capacity is at least 30 percent, and as measured by porosity.
- Permeability is at least 1.5 inches per hour. Permeability is vertical hydraulic conductivity at the specified unit weight noted above.
- Organic content is no more than 10% by volume.
- pH is between 6.5 and 8.0.
- Soluble salts are less than 3.5 g (KCL)/L.
- Sorption capacity exceeds 0.005 mg OP/mg media.

(f) **Growth Media** - The growth media is intended to be the main support course for the vegetation. The growth media is installed on top of the separation fabric. Growth media will meet all of the following specifications.

- Unit Weight is no more than 45 pounds per cubic foot when dry.
- No more than ten percent of the particles passing the #200 sieve.
- Contains no shale.
- At least three inches in thickness.
- Water holding capacity is at least 30 percent, and as measured by porosity.
- Permeability is at least 1.5 inches per hour. Permeability is vertical hydraulic conductivity at the specified unit weight noted above.
- Organic content is no more than ten percent by volume.
- pH is between 6.5 and 8.0.
- Soluble salts are less than 3.5 g (KCL)/L.

(g) **Preventing wind uplift** – To assure that a green roof built in Florida remains operable, the green roof must be designed to prevent wind uplift. A three-dimensional netting made of polyamide (nylon) filaments connected together woven into the growth media layer or other equivalent method is

acceptable. As an alternative, a parapet of sufficient height can be used. For buildings less than 100 feet tall, a parapet height of 36 inches can be used in place of wind netting.

- (h) **Vegetation** – Florida native vegetation is recommended on green roofs used for stormwater treatment. Low maintenance plants and drought tolerant plants are recommended but not mandatory because of the use of stored stormwater for irrigation. However, plants tolerant to high levels of direct sunlight and high temperatures are necessary for the success of a healthy green roof plants. Care should be made to ensure that the available root zone of the green roof is sufficient for the intended plants. When designing an intensive green roof, larger plants with more rigorous maintenance schedules are acceptable. Plants must achieve at least 80% cover of the green roof area within one year of planting. When the vegetation density is less than 80%, new plants will be added. Table 4.7.1. includes plants that have been successfully used on green roofs in the different parts of Florida. Other plants are acceptable, and applicants are encouraged to consult landscape architects and native nursery personnel for appropriate plants. Note for plants used on green roofs in coastal areas, salt tolerance is an important consideration. Some examples of plants used along the coast are Simpson stopper, Snake plant, Muhly grass, Inkberry, and Beach sunflower.

Table 4.7.1. Plants that have been successfully used on green roofs in Florida

<i>PLANT</i>	<i>NORTH FL</i>	<i>CENTRAL FL</i>	<i>SOUTH FL</i>
Muhly grass	X	X	X
Butterfly Weed		X	X
Blanket Flower	X	X	X
Sunshine mimosa		X	X
Perennial peanut	X	X	X
Snake weed		X	X
Asiatic Jasmine	X	X	X
Simpson Stopper		X	
Black Eyed Susan	X	X	
Beach Sunflower	X	X	X

- (i) **Irrigation** - Irrigation is required on all green roofs in Florida to assure plant survival and to recover the required treatment volume. A rain sensor is required to monitor rainfall and the need for irrigation. Drip irrigation applied at the growth media surface is required, usually with one foot on-center spacing. Irrigation pumps must be installed with an alarm system to signal any mechanical problems. Irrigation will vary by season and a rain shut-off sensor is required. Flow meters will be installed as a means of documenting when irrigation occurs, and the volume of water used for irrigation. The addition of make-up water will be required during parts of the year depending on local rainfall patterns and records must be kept to document how much make-up water is added. The recommended source of make-up water is stormwater or gray water, whenever available. An in-line filter is recommended to reduce the maintenance problems and cost of irrigation line replacement. Depending upon the green roof retention volume and design, irrigation will occur three to four times per week with a maximum total application of one (1.0) inch per week if filtrate or stormwater are available.
- (j) **Roof Drain** - The green roof must drain into a storage device, typically a cistern. The slope of the roof must be at least ¼ inch per foot. The primary drain can be an interior drain or gutter drain. A one foot barrier must be maintained around the drain to prevent vegetation and debris from clogging drain as well as providing easy inspection. This barrier can be an aluminum break or a washed river stone

section. An overflow will also be provided to ensure drainage in the event that a clog occurs in the primary drain.

- (k) **Cistern or Other Water Storage Area** - The cistern or other water storage area serves to store filtrate for use as irrigation. Filtrate volumes in excess of those required for irrigating the green roof can be used to either irrigate ground level landscaping or can be directed to other retention BMPs that allow for infiltration. If there is a discharge to a wet detention system, then the green roof efficiency must be calculated using the BMP Treatment Train equations. Cistern or other storage placement can be below ground or above ground. If an above ground cistern is used it must be UV stable, dark in color, and must be placed in areas of low to no direct sunlight. Direct sunlight may cause irrigation water temperature to get too hot for plants.

4.7.6. Design Criteria for Management of the Filtrate

There are two common designs for management of the filtrate. The first design is to collect filtrate from a green roof in a cistern. The cistern has no other water inputs except for supplemental makeup water. It is also not open to the atmosphere. Water in the cistern is used to irrigate the green roof, or other nearby landscaping, or can be used for other non-potable purposes. Cistern annual volume reduction equations and graphs as a function of cistern storage were developed and are used to estimate retention as a function of the storage volume. For this design management of filtrate, the yearly mass reduction is equal to the yearly volume reduction. Cistern design curves are provided in Section 6.10.8 of this Manual for green roofs and for irrigation rates commonly used in Florida. The design curves provide the amount of cistern storage required for a specified annual retention of rainfall or reduction in discharge from the green roof and cistern system.

The second design condition is when the green roof filtrate is discharged from the roof into a conveyance system or into another BMP such as a wet detention pond. For this case, the removal of the nutrient is proportional to the removal effectiveness of the pond. However, note that the flow to the pond without a cistern is reduced by 44 percent.

4.7.7. Construction requirements

To assure proper construction of the green roof/cistern system the following construction procedures are required:

- (a) Construct the green roof in accordance with permitted design plans and specifications.
- (b) Be sure that all green roof waterproofing components are properly installed before placing any of the media on the green roof.
- (c) Be sure all equipment and plants are properly sited per design drawings and installed properly.
- (d) Construct the irrigation system in accordance with all permitted design specifications and irrigation system design standards.
- (e) Assure that all irrigation components are properly sited and that irrigation spray heads are working properly and not spraying irrigation water onto impervious areas.

4.7.8. Inspections, Operation and Maintenance

Maintenance issues associated with green roof/cistern systems are related to the health of the plants, the drainage capabilities of the system, and proper functioning of the irrigation system.

Green roof/cistern systems must be inspected annually by the operation and maintenance entity to determine if it is operating as designed and permitted. Reports documenting the results of annual inspections will be filed with the County every three years.

(a) Inspection Items:

(1)	Inspect operation of the green roof/cistern system to assure that rainfall is flowing properly through the green roof and into the cistern.
(2)	Inspect the plants on the green roof to assure they are healthy and growing. Assure plants are covering at least 80% of the surface area of the green roof and that plant species not on the approved plant list are not becoming established.
(3)	If an intensive green roof, inspect it for damage by foot traffic or other human uses of the green roof.
(4)	Inspect the operation of the pumping system and the irrigation system to assure they are working properly.

(b) Maintenance Activities As-Needed to Prolong Service:

(1)	Repair any components of the green roof drainage system which are not functioning properly and restore proper flow of stormwater or filtrate.
(2)	Maintain the plants on the green roof on an as needed basis to assure healthy growth and meet the required 80 percent coverage of the green roof. Weeding to remove plants not on the approve design plant list will be needed on a regular basis. Whenever plant coverage is less than 80%, new plants will be established as soon as possible.
(3)	Repair any damage to the green roof by foot traffic or other human uses.
(4)	Repair or replace any damaged components of the pumping and irrigation system as needed for proper operation.

(c) Record keeping

The owner/operator of a green roof/cistern system must keep a maintenance log of activities that is available at any time for inspection or recertification purposes. The log will include records related to the use of the filtrate water for irrigation to demonstrate that the permitted nutrient load reduction is being achieved. A flow meter to measure the quantity and day/time of irrigation is required. Visual observations of the success of plant growth and cover, including photo documentation is also required. The maintenance log will include the following:

- (1) Irrigation volume measured using a flow meter specifying the day and amount,
- (2) Cistern overflow volumes and makeup water volumes,
- (3) Observations of the irrigation system operation, maintenance, and a list of parts that were replaced,
- (4) Pruning and weeding times and dates to maintain plant health and 80% coverage,
- (5) A list of dead, dying, or damaged plants that are removed and replaced,
- (6) Maintenance of roof mechanical equipment,
- (7) Dates on which the green roof was inspected and maintenance activities conducted, and
- (8) Dates on which fertilizer, pesticide, or compost was added and the amounts used.

4.7.9. Green roof Cistern/Harvesting Design Curves and Equations

A cistern is used with a green roof to store the water and then the stored water is reused on the green roof

for irrigation. By doing this, the direct discharge to surface water is reduced. Wanielista and Hardin (2006) showed that a cistern designed to collect 5 inches of rainfall from a green roof with pollution control media composed of a blend of tire crumb, was able to remove at least 90% of the mass of Soluble Reactive Phosphorus (SRP) and 98% of the mass of Nitrate Nitrogen. These removals were measured over one year and depend on the rainfall conditions in that year. The size of the cistern is dependent on local rainfall conditions and the rate of water used from the cistern.

The green roof and cistern functions to attenuate, evaporate, and lower the volume of discharge coming from a roof surface. The green roof system will also neutralize acid rain, reduce mass of pollutants, and attenuate hydrographs. The storage discharge design of the cistern determines the attenuation. A green roof with cistern will achieve higher stormwater volume and load reductions (greater than 70%) than if used without a cistern (~ 40%). When used with a cistern, the cistern discharge will have less pollutant mass than discharge without a cistern. Design graphs have been developed for many locations in the State (Hardin, 2006 and Hardin and Wanielista, 2007). The green roof/cistern harvesting design curves and equations for Pinellas County can be found in section 6.10.8 of Part C-Design Guide.

4.8. Wet Detention System

4.8.1. Description

Wet detention systems are permanently wet ponds that are designed to slowly release a portion of the collected stormwater runoff through an outlet structure. A schematic of a typical wet detention system is shown in Figure 4.8.1.

Wet detention systems are often an effective BMP for sites with moderate to high water table conditions. Wet detention treatment systems provide removal of both dissolved and suspended pollutants by taking advantage of physical, chemical, and biological processes within the pond. They are relatively simple to design and operate, provide a predictable recovery of storage volumes within the pond, and are easily maintained by the maintenance entity.

There are several components in a wet detention system that must be properly designed to achieve the level of stormwater treatment described herein. A description of each design feature and its importance to the treatment process is presented below. The design and performance criteria for wet detention systems are discussed below.

WET DETENTION SYSTEM SUMMARY

Advantages/Benefits	Reduces peak discharge rate and pollutant loadings. May have some infiltration depending on soil, SHGWT conditions, and control elevation. Provides a source of fill, creates “waterfront property” and enhanced site aesthetics.
Disadvantages/Limitations	Can require large footprint. Lower pollutant load reductions than provided by retention BMPs. Do not construct within 50 feet of a public or private potable water supply well or within 15 feet of an onsite wastewater disposal and treatment system.
Volume Reduction Potential	Low
Pollutant Removal Potential	Low to moderate for all pollutants. TN load reduction ranges from 30 to 40% while TP load reduction varies from 50 to 80%.
Key design considerations	Pollutant removal directly related to residence time and permanent pool volume; control elevation above the SHGWT; depths over 12 feet generally prohibited unless aeration provided; flow path ratio greater than 0.80; recovery half of bleed-down volume within 24 to 30 hours; of treatment volume within 24 – 72 hours; side slopes no steeper than 4:1 unless fenced; sides must be stabilized with vegetation or other approved materials

Advantages/Benefits	Reduces peak discharge rate and pollutant loadings. May have some infiltration depending on soil, SHGWT conditions, and control elevation. Provides a source of fill, creates “waterfront property” and enhanced site aesthetics.
Key construction and maintenance considerations	Can use for erosion and sediment control during construction but may have to remove sediment; ensure all inlets and outlets are well stabilized; use energy dissipaters as needed to prevent scour; inspect for accumulating sediment and impact on storage volume; inspect and keep inflows, outflows, skimmers, etc. clear of debris or trash and structurally sound; identify and eliminate mosquito breeding problems.

THE REMAINDER OF THIS PAGE INTENTIONALLY LEFT BLANK

4.8.2. Treatment required

The required nutrient load reduction is set forth in the performance standards in **Section 3.1.1.** of this Manual.

4.8.3. Bleed-down Volume

The bleed-down volume will be the first one inch of runoff from the contributing area. For wet detention systems, the bleed-down volume is defined as the zone between the elevation of the overflow weir and the control elevation. The overflow weir is generally set to accommodate stormwater quantity and flood control criteria. The control elevation is the “normal” water level for the pond. It is established as the higher elevation of either the normal wet season tailwater elevation or the SHGWT, unless this creates adverse impacts to wetlands at or above the control water table elevation. The maximum stage above the control elevation for providing the bleed-down volume will not exceed 18 inches unless the applicant demonstrates, based on plans, test results, calculations or other information, that an alternative design is appropriate for the specific site conditions.

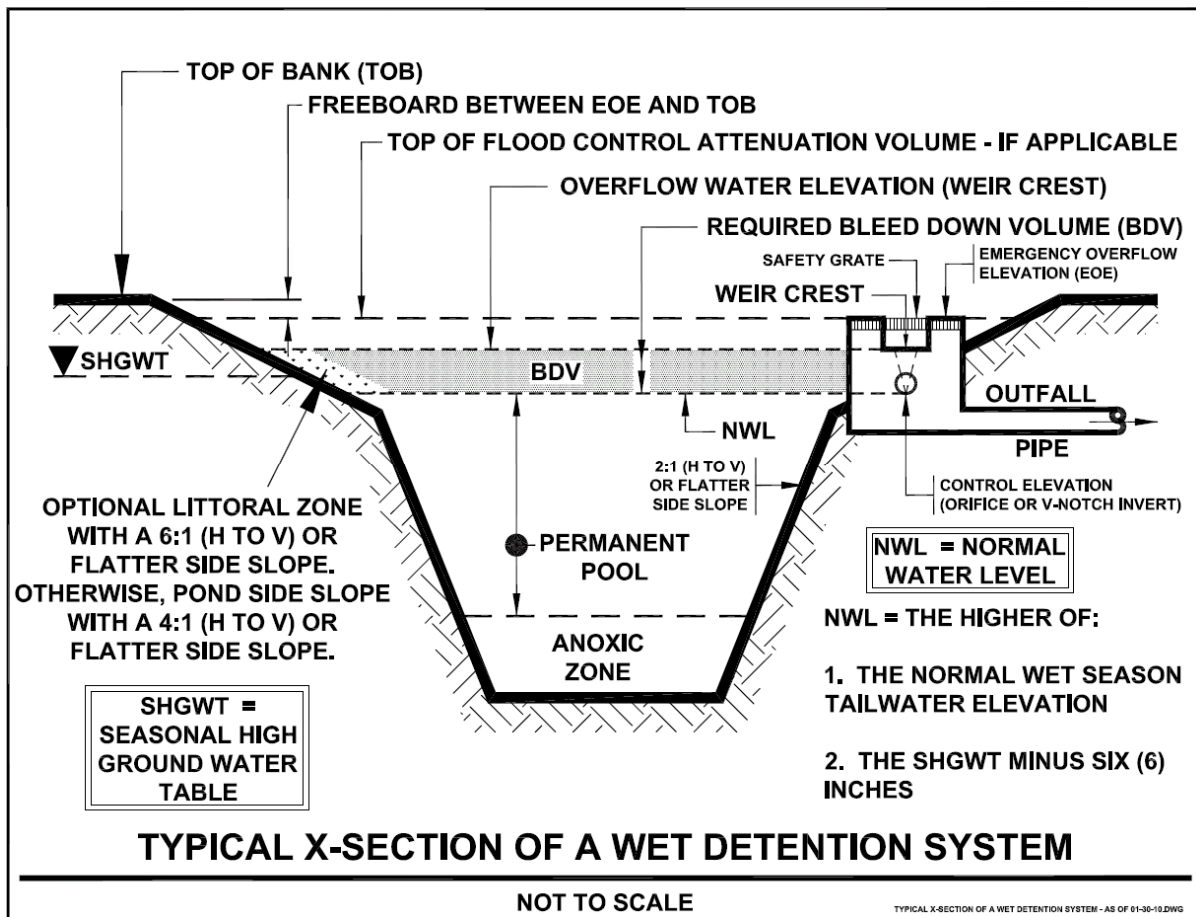

Figure 4.8.1. Typical Cross Section of a Wet Detention System.

4.8.4. Design Criteria



- (a) **Required nutrient reduction** - The wet detention system, either by itself or as part of a BMP treatment train, will achieve the required level of nutrient load reduction as specified in **Section 3.1.1.** of this Manual.
- (b) **Permanent Pool** - The most significant component and design criterion with respect to nutrient load reduction of a wet detention system is the storage capacity of the permanent pool (i.e., the section of the pond that holds water at all times). Important pollutant removal processes that occur within the permanent pool include: uptake of nutrients by algae, adsorption of nutrients and heavy metals onto bottom sediments, biological oxidation of organic materials, and sedimentation. Uptake by algae is one of the most important processes for the removal of nutrients. Sedimentation and adsorption onto bottom sediments is likely the primary means of removing heavy metals.

The permanent pool will be sized to provide a residence time that achieves the required nutrient removal efficiency, if possible. It is recognized that required treatment efficiencies may not be achievable with a wet detention system alone, due to inherent limitations associated with this BMP. Residence time will be based upon annual rainfall volumes. Also, it is recognized that wet detention systems used in-series also have limitations regarding the maximum treatment that can be expected, resulting in so-called irreducible concentrations, below which the BMP is incapable of treating. Irreducible concentrations for TN and TP are established as 0.40 and 0.010 mg/L, respectively. In the case where the wet detention system alone cannot achieve the required treatment efficiency, a BMP treatment train must be used that incorporates other BMPs.

To make it easier to determine the pollutant load reduction associated with varying residence time, a table based on removal efficiency analysis completed by Harvey Harper and David Baker of Environmental Research and Design, Inc. (2007) is provided below. For more information on the development of this table and associated graphs, see section 6.10.9 of Part C-Design Guide, Removal Efficiency of TP and TN Based on Residence Time.

Table 4.8.1. Relationship between TP and TN Load Removal and Wet Detention Residence Time

RESIDENCE TIME	TP REMOVAL	TN REMOVAL	
	$Eff = 44.53 + (6.146 \cdot \ln Td) + (0.145 \cdot (\ln Td)^2)$	$Eff = (43.75 \cdot Td) / (4.38 + Td)$	
14	61.51	33.32	
21	64.12	36.20	
30	66.42	38.18	
50	69.71	40.23	
100	74.01	41.91	
150	76.78	42.51	
200	78.63	42.81	
250	80.07	43.00	

- (c) **Pond Depth** – The maximum depth to be used in calculating the water quality permanent pool volume will be no greater than 12 feet, unless the applicant demonstrates, based on Equation 4.8.1., that an alternative depth is appropriate for the specific site conditions. The maximum allowable permanent pool depth as it relates to the aerobic zone is directly related to the anticipated algal productivity within the pond. The maximum depth of the pond may be deeper, provided the applicant demonstrates that permanent pool

credit for deeper pond depths only includes volumes that are based on the depth below the control elevation that remains aerobic throughout the year (based on a monthly analysis). The general relationship for determining the depth to anoxic conditions is expressed as the following equation:

Equation 4.8.1.:

$$\text{Depth of DO} < 1 = 3.035 * \text{Secchi} + 0.02164 * (\text{chl-a}) - 0.004979 * \text{Total P}$$

Where: DO = dissolved oxygen (mg/L)

Secchi = estimated Secchi depth (meters)

Chl-a= estimated chlorophyll a (mg/m³) Total

P = estimated Total Phosphorus (ug/L)

The above calculation must be performed on a monthly basis in order to determine the most limiting time of year (month with shallowest depth to the anoxic zone). Alternatively, the depth to the anoxic zone can be calculated using Equation 4.8.1. for average annual conditions and multiplying the resultant depth by 0.75. Additional methods and assurances will be required if the wet pond is anticipated to receive sediment or nutrient loads in excess of those calculated from the EMCs since Equation 4.8.1. may not be applicable for that condition.

The mean pond depth will be at least six feet unless an applicant demonstrates that an alternative depth is appropriate for the specific site conditions. The mean pond depth is calculated by dividing the pond volume at the normal water level elevation by the surface area of the pond at the normal water level elevation. The mean depth requirement is necessary to ensure a minimum depth throughout the pond that will reduce opportunities for nuisance plant species to be established. If a shallower mean depth is proposed for the site, the permittee will be required to implement additional operating and maintenance provisions to assure that the system does not become dominated by cattails or other undesirable vegetation.

- (d) **Pond Configuration** - It is important to maximize the flow path of water from the inlets to the outlet of the pond to promote good mixing of stormwater. Under these design conditions, short circuiting is minimized, and pollutant removal efficiency and mixing is maximized. The flow weighted average inlet to outlet ratio, or flow path ratio (FPR), will be 0.80 or greater, using the following methodology:

For each inlet, using the percent of inflow, calculate the FPR using Equation 4.8.2

Equation 4.8.2 Flow Path Ratio (FPR) =SUM ((A/LP)_i * V_i)

Where: A_i = actual travel distance for inflow i

LP_i = longest possible travel distance for inflow i

V_i = fraction of annual runoff volume contributed by inflow i

If short flow paths are unavoidable, the effective flow path can be increased by adding diversion barriers such as islands, peninsulas, or baffles to the pond. Inlet structures will be designed to dissipate the energy of water entering the pond.

- (e) **Control Elevation** - The control elevation is the “normal” water level for the pond. The control elevation will be established as the higher elevation of either the normal wet season tailwater elevation or the SHGWT minus six inches, unless this creates adverse impacts to wetlands at or above the control water table elevation. However, specific site conditions may allow deviation from this requirement. Accordingly, an applicant may request the County approve another control elevation based upon evaluation of the proposed elevation on:

- Maintaining existing water table elevations in existing well field cones of depression;
- Maintaining water table elevations needed to preserve environmental values at the project site and prevent the waste of freshwater;
- Maintaining minimum flows or levels of surface waters established pursuant to Section [373.042, F.S.](#)
- Assuring that water table elevations will not be lowered such that the existing rights of others will be adversely affected;
- Preserving ground water recharge characteristics of the project site;
- Maintaining ground water levels needed to protect wetlands and other surface waters;
- Creating adverse impacts on surrounding land and project control elevations and water tables;
- Creating conflicts with water use permitting requirements or water use restrictions;

The County will approve an alternative control elevation and its effects on the factors above based on a demonstration by the applicant, using plans, test results, calculations or other information, that the alternative design is appropriate for the specific site conditions and will meet the above considerations.

- (f) **Ground water nutrient loads** - If the control elevation is located more than six inches below the SHGWT, nutrient loads from base flows must be accounted for in the nutrient loading and nutrient removal calculations.
- (g) **Reclaimed water nutrient loads** – If reclaimed water is discharged into a wet detention system that will discharge, the nutrient loads from the overspray of reclaimed water must be accounted for in the nutrient loading and nutrient removal calculations.
- (h) **Recovery Time** - The outfall structure will be designed to drawdown one half of the required bleed-down volume within 24 hours to 30 hours. If the minimum bleed-down device specified in (i) below will result in a quicker drawdown it will be allowed.
- (i) **Outlet Structure** - The outlet structure generally includes a drawdown device (such as an orifice, "V" or square notch weir) set to establish a normal water control elevation and slowly release the bleed-down volume (see Figures 4.8.4. and 4.8.5. for schematics). The design of the outfall structure must also accommodate the passage of base flows or flows from upstream stormwater management systems, if applicable (see Figure 4.8.6.).

Also, drawdown devices will incorporate minimum dimensions no smaller than two inches minimum width or less than 20 degrees for "V" notches. Bleed-down devices incorporating dimensions smaller than six inches minimum width or less than 45 degrees for "V" notches will include a device to minimize clogging. Examples of such devices include baffles, grates, screens, gravel filled corrugated metal pipes, and pipe elbows.

- (j) **Pond Side Slopes** –For purposes of public safety, wet detention basins will be restricted from public access or contain side slopes that are no steeper than 4:1 (horizontal: vertical) from the top of bank out to a depth of two feet below the control elevation. All side slopes will be stabilized by either vegetation or other materials to minimize erosion and subsequent sedimentation of the pond. Deeper areas of the pond must maintain horizontal to vertical side slopes no steeper than 2H:1V provided geotechnical evidence is provided that such slopes will be stable.
- (k) **Littoral Zones** - If the applicant proposes to include a littoral zone, the design will meet the requirements in **Section 4.11.** of this Manual.
- (l) **Removal of Exotic or Nuisance Plant Species** – In wet detention ponds without a littoral zone, exotic

or nuisance species such as cattails or primrose willow will be removed as necessary to prevent their long-term establishment.

- (m) **Setback from Potable Wells and Septic Tanks** – Wet detention systems will not be constructed within 50 feet of a public or private potable water supply well or within 15 feet of an onsite wastewater disposal and treatment system.

4.8.5. Required Site Information

Successful design of a wet detention system depends heavily upon conditions at the site, especially information about the soil, geology, and water table conditions. At a minimum, site specific information on the depth to the seasonal high ground water table and the presence and location of aquitard/confining unit is required when designing a wet detention system. Information related to determining the SHGWT, the location of aquitards/confining layers, and hydraulic conductivity (if applicable for radius of influence and ground water inflow computations) is specified in Appendix A of this Manual.

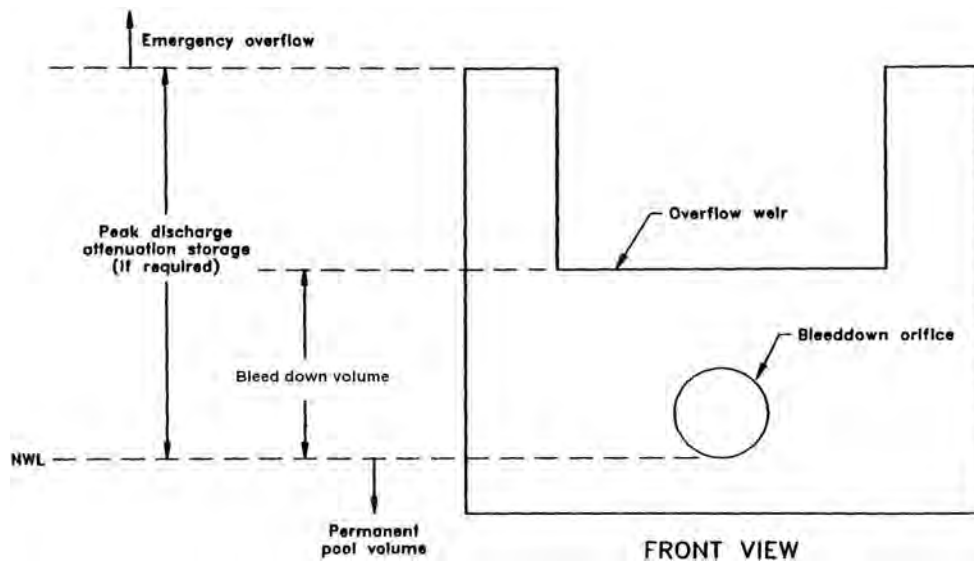

Figure 4.8.4. Typical Wet Detention Outfall Structure (N.T.S.).

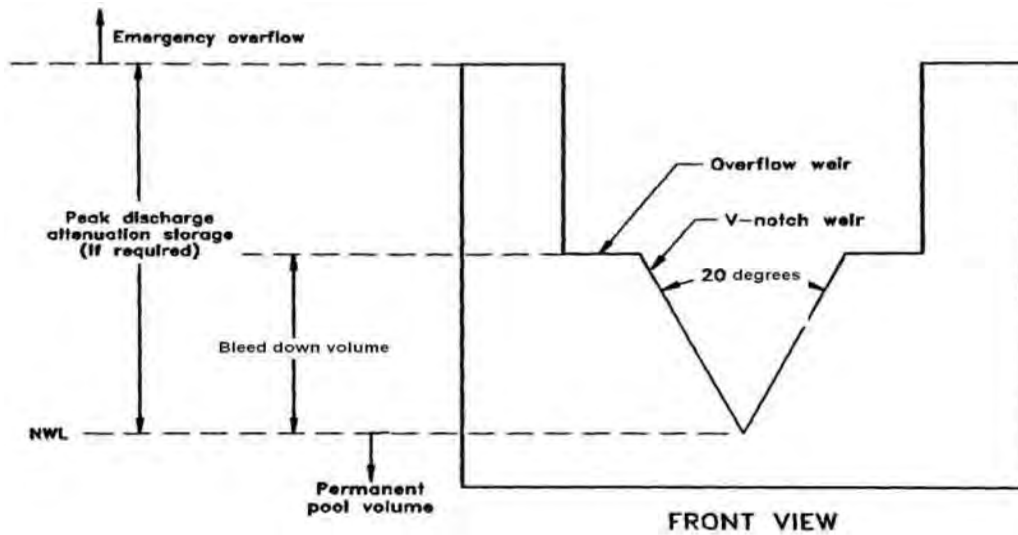

Figure 4.8.5. Typical Wet Detention Outfall Structure with "V"-notch Weir (N.T.S.).

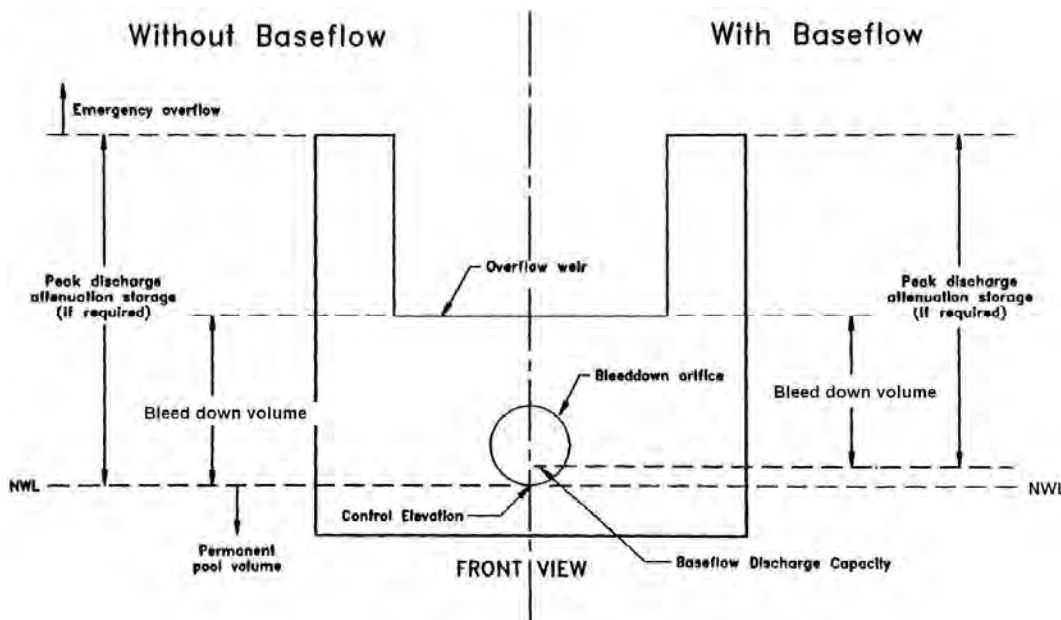

Figure 4.8.6. Typical Wet Detention Outfall Structure with and without Baseflow Conditions (N.T.S.).

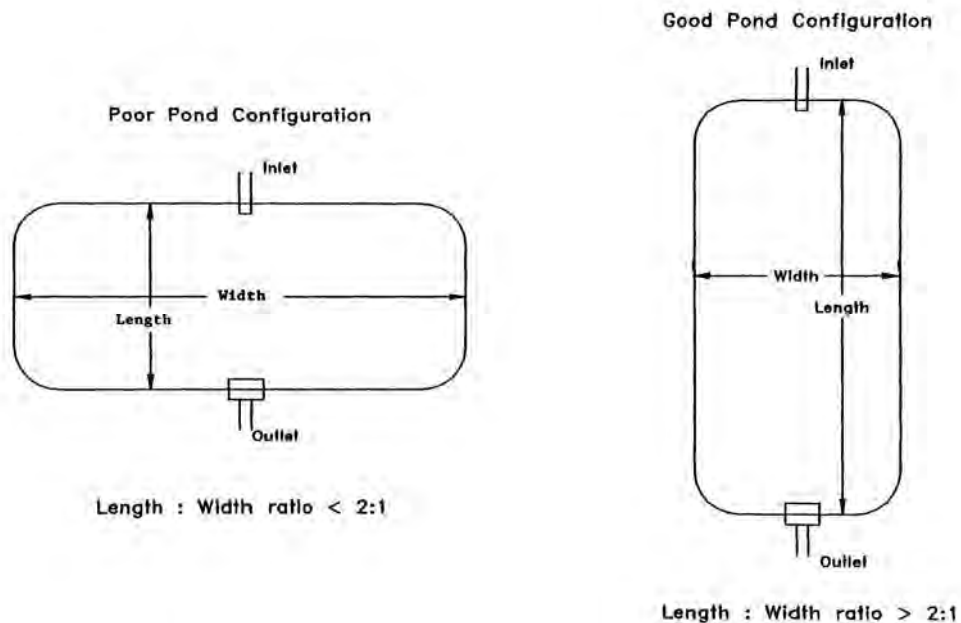

Figure 4.8.7. Examples of Good and Poor Wet Detention Pond Configurations (N.T.S.).

4.8.6. Detention Pond Construction

Wet detention basin construction procedures are important in assuring the long-term operation and safety of the system, especially if the pond is constructed using an embankment rather than through excavation. In either case, it is important that the discharge structure be properly designed and constructed to prevent its failure.

The following construction procedures are required to assure proper construction of the wet detention pond:

- (a) The location and dimensions of the detention pond will be verified onsite prior to its construction. All design requirements including detention pond dimensions and distances to foundations, septic systems, and wells need to be verified.
- (b) Once excavation of the wet detention pond begins, the soil types need to be verified to ensure that they are suitable for the pond.
- (c) If the wet detention pond is being created by construction of an embankment, rather than solely through excavation, special attention during construction must be focused on the embankment's construction, especially of any pipes that are part of the discharge structure that are built through the embankment.
- (d) To minimize the potential that an embankment will fail, inspection of the structure throughout its construction are needed to assure that components such as anti-seep collars or diaphragms and soil compaction are done properly.
- (e) All elevations need to be verified in the field as construction occurs to assure that they are consistent with permitted plan specifications.
- (f) All inlets and outlets will be stabilized as set forth in the permitted plans to prevent erosion, scour, and sedimentation.

An applicant may propose alternative construction procedures to assure that the design infiltration rate of the constructed and stabilized retention basin is met.

4.8.7. Inspections, Operation and Maintenance

Maintenance issues associated with wet detention ponds include assuring that sediments are not accumulating to such a degree that they are decreasing the required storage volume and assuring that all inlets, outlets, and discharge structures are not clogged or damaged structurally.

(a) Inspection Items:

(1)	Inspect basin for excessive sediment accumulations that decrease the wet detention pond's permitted storage volume.
(2)	Inspect inflow and outflow structures, trash racks, skimmers, and other system components for accumulation of debris and trash that would cause clogging and adversely impact operation of the wet detention pond.
(3)	If an embankment is used, inspect to ensure that no piping of water is occurring through the embankment and that there is no damage or structural integrity issues.
(4)	Inspect vegetation on side slopes to assure it is healthy, maintaining coverage, and that no erosion is occurring.
(5)	Inspect the wet detention pond for potential mosquito breeding problems
(6)	Inspect wet detention pond and, if applicable, littoral zone to assure that cattails or other invasive vegetation are not becoming established.

(b) Maintenance Activities As-Needed to Prolong Service:

(1)	If needed, remove accumulated sediments to restore permitted storage volume and dispose of properly Please note that stormwater sediment disposal may be regulated under Chapter 62-701, F.A.C.
(2)	Remove trash and debris from inflow and outflow structures, trash racks, and other system components to prevent clogging or impeding flow.
(3)	Maintain healthy vegetative cover to prevent erosion of side slopes or around inflow and outflow structures. Remove any trees or shrubs that may have become established on the discharge structure embankment, if applicable.
(4)	Eliminate mosquito breeding habitats such as thick growths of cattails and ensure that mosquito fish are present in the wet detention pond.
(5)	Remove cattails and other exotic vegetation from the littoral zone, if applicable, and replant appropriate vegetation if needed to meet littoral zone requirements.

4.8.8. Calculating Residence Time

As seen in Figures 6.10.3. and 6.10.4 in Part C-Design Guide, the average TN and TP load reduction in a wet detention system is directly related to the residence time that the stormwater spends within the system before discharge. The longer the residence time, the more time that the various pollutant load reduction mechanisms within the wet detention system have to work.

The basic formula for calculating residence time is:

$$Rt = V/Q$$

Where Rt is residence time, V is the volume of the wet detention system permanent pool, and Q is the average flow rate for the period of time.

This units and time frame is usually tied to the prediction of effectiveness or the way effectiveness was determined. As an example, for wet detention, the effectiveness relationship is to the average annual flow values and using the permanent pool. Thus V = permanent pool in cubic feet, and Q is the average flow is cubic feet/day. Thus, time is in days. Questions always arise on the calculation of Q as inflow or outflow. Inflow is usually larger and thus there is a more conservative estimate of time (time is lower). Also outflow Q may not be possible to calculate until a final design, and groundwater input into a pond can affect the outflow. Therefore, the inflow Q should be used in the calculations.

4.9. Stormwater Harvesting Systems

4.9.1. Description

Stormwater harvesting uses treated stormwater for beneficial purposes thus reducing the stormwater volume and mass of pollutants discharged from a retention or wet detention system. It is most often used with wet detention as part of a BMP treatment train. The harvested stormwater can be used for numerous uses including irrigating lawns and landscape beds, irrigating green roofs, washing vehicles, industrial cooling and processing, and toilet flushing. To properly design a stormwater harvesting system that will result in a predictable average annual mass removal, water budgets are required. A water budget is an accounting of water movement on to, within, and off of an area. The development of a water budget for stormwater harvesting is done to quantify the reduction in offsite discharge for a given period of time. Individual components of storage volume, rate of use, and discharge can be accounted for in the water budget. Calculation of these components requires knowledge of many variables, such as: watershed characteristics, water use volumes and rates, desired percentage of stormwater runoff to be used, maximum volume of stormwater runoff storage, rainfall data, and evaporation data.

The results of long-term simulations of stormwater harvesting ponds over time are presented as Rate-Efficiency-Volume (REV) curves. The REV curves will be used to design stormwater harvesting systems to improve the nutrient removal effectiveness of wet detention ponds such that these systems meet the performance standards described in Section 3.5. of this Manual. Stormwater harvesting curves (REV curves) are provided in Section 4.9.7. of this Manual.

Important assumptions that must be understood when using the REV curves include:

- (a) Net ground water movement into or out of the pond is assumed to be zero over the period of simulation.
- (b) The use rate is kept constant for each month in a year and presented on the REV curves as an average rate per day and over the equivalent impervious area (EIA).
- (c) The effectiveness results are long-term averages based on historical rainfall records. The average values for each year will be different because of annual rainfall volumes and distribution.
- (d) Soil storage in the irrigated area and plant ET are not limiting irrigation application rates.

It should be noted that a supplemental water supply is needed in the dry season when the pond harvested volume is typically depleted. Also, for a design of a stormwater harvesting system which does not meet one of the above assumptions, the applicant can develop a site-specific water budget analysis to meet the required performance standard and design criteria.

STORMWATER HARVESTING SYSTEM SUMMARY

Advantages/Benefits	Reduces the volume of stormwater discharged from a wet detention system thereby increasing treatment effectiveness; reduces potable water use and reuses stormwater for irrigation and other non-potable purposes; provides ground water recharge and water reuse.
Disadvantages/Limitations	Requires a pump, flow meter, and filtration system, depending on the determined uses of harvested stormwater; need area to be irrigated or other use of the water; may require a Water Use Permit from SWFWMD.
Volume Reduction Potential	Moderate to High depending on use for harvested stormwater, size of irrigation area, and irrigation rate and schedule.
Pollutant Removal Potential	Moderate to High for all pollutants
Key design considerations	Determine use for harvested stormwater (irrigation, graywater, potable); determine equivalent impervious area, harvesting rate, volume, irrigation method, and equipment; use Rate-Efficiency-Volume (REV) curve to specify storage volume and harvesting rate; filter harvested stormwater through horizontal wells or equivalent filter systems; obtain additional requirements for graywater or potable use from Pinellas County Health Department; recovery of bleed-down volume within 24 – 30 hours;
Key construction and maintenance considerations	Ensure proper construction of retention or wet detention system; assure that all components of the harvesting and reuse system are properly sited and operational; ensure irrigation spray heads do not direct water onto impervious surfaces; inspect all components of system on regular basis to ensure proper operation; maintain pumping and irrigation records as required.

4.9.2. Treatment required

The required nutrient load reduction will be determined by type of water body to which the BMP treatment train that includes stormwater harvesting discharges and the associated performance standard as set forth in **Section 3.1.1.** of this Manual. The nutrient removal credits associated with stormwater harvesting will be calculated using the REV Curves and the BMP Treatment Train Equations set forth below. The [BMPTRAINS](#) software, ICPR version 4, or equivalent may be used to design the system and determine the nutrient removal credits.

4.9.3. Equivalent Impervious Area

When designing stormwater harvesting systems, the runoff characteristics of the watershed must be calculated. The overall runoff coefficient (C) for an area composed of different surfaces can be determined by weighting the runoff coefficients for the surfaces with respect to the total areas they encompass and is based on the rainfall volume used to calculate the maximum volume for use.

$$C = \frac{C_1 A_1 + C_2 A_2 + \dots + C_N A_N}{A_1 + A_2 + \dots + A_N}$$

where: C_N = Runoff coefficient for surface N

A_N = Area of surface N

This weighted runoff coefficient (C) is termed the effective runoff coefficient and is representative of the entire watershed.

The equivalent impervious area (EIA) is equal to the product of the total area of the watershed (A) and the effective, or weighted, runoff coefficient (C) for the watershed:

$$EIA = CA$$

Where: EIA = Equivalent impervious area (acres)

C = Effective runoff coefficient for the watershed

A = Area of watershed (acres)

The area of the EIA is defined as the area of a completely impervious watershed that would produce the same volume of runoff as the actual watershed. For example, a 20-acre watershed with an effective runoff coefficient (C) of 0.5 would have an EIA of ten-acres (20 ac x 0.5). If one inch of rain fell on this ten-acre impervious area, the runoff volume would be 10 ac-in (10 ac x 1 in). If the same amount of rain fell on the actual watershed the runoff volume would not change:

$$20 \text{ ac } (1 \text{ in}) (0.5) = 10 \text{ ac-in}$$

The EIA will be expressed in acres when using this methodology. The use of the EIA serves to generalize the model so that it can be applied to a watershed of any size and runoff characteristics or as applied to a volume of water used. The product of inches of water used and the area is a volume term. The EIA for a watershed will include the area of the pond when using this methodology.

4.9.4. Design Criteria

- 
- (a) The wet detention design criteria in Section 4.8.4 of this Manual, with the exception of 4.8.4(h) and 4.8.4. (i), are applicable to stormwater harvesting systems.
 - (b) The stormwater harvesting system will be designed using the Rate-Efficiency-Volume (REV) Curves and methodology set forth in Section 4.9.7. of this Manual.
 - (c) **Runoff Storage Volume** - The runoff storage volume (V) is similar to the “bleed-down volume” or the temporary storage volume in a wet detention pond (Figure 4.9.1.). The major difference between a stormwater harvesting pond and a wet detention pond is the operation of the temporary storage volume. For typical wet detention systems, the bleed-down volume is designed to be discharged to adjacent surface waters using a flow limiting structure. On the other hand, in a stormwater harvesting pond the runoff storage volume is not discharged to adjacent surface waters but is used for some beneficial purpose.

Runoff storage volumes are expressed in units of inches over the EIA . The values can be converted to more commonly used units such as acre feet or cubic feet using simple conversions. It should also be noted that in most cases, stormwater harvesting can provide for most of the water needed but the runoff storage volume will not be sufficient to supply all the water needed over a year, especially in dry periods. Thus, a backup supply should be planned. A back up supply is one that provides for less than the majority of water needed. If water is taken from the permanent pool of the wet detention system for irrigation, the applicant must demonstrate that the lowering of the permanent pool will not adversely affect surface waters or wetlands.

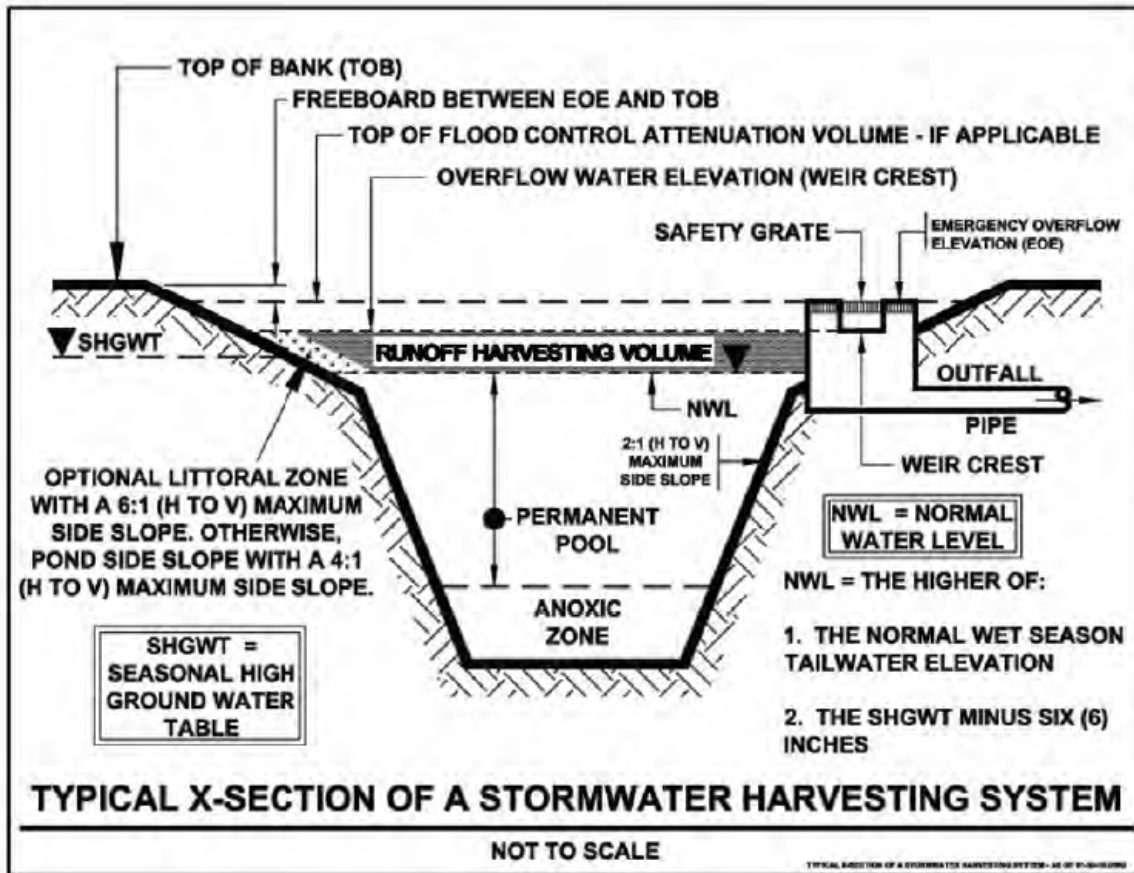

Figure 4.9.1. Typical Cross Section of a Stormwater Harvesting System.

- (d) **Minimum Quality of Harvested Stormwater** – Treated harvested stormwater that is used for irrigation is withdrawn from the stormwater treatment system in a manner that minimizes turbidity, bacteria, pathogens and algal toxins. This can be done by filtering the stormwater to be harvested through a minimum of four feet of native soils or clean sands. This can be accomplished by withdrawing water through a horizontal well configuration located directly adjacent or under the stormwater harvesting pond or by the use of a mechanical sand or disc filter. See Figures 4.9.2. and 4.9.3. for a detailed schematic of approved withdrawal systems.

Withdrawal of irrigation water from the stormwater harvesting pond in this manner effectively removes algae, turbidity, and other solids that may clog spray heads and materials that may be considered adverse to human health when converted to an aerosol condition. Acceptable alternatives include in-pipe treatment filtration or a mechanical filter used to remove detained water from ponds. If an applicant proposes to use an alternative to horizontal wells, an affirmative demonstration must be made by the applicant, based on plans, test results, calculations or other information, that the alternative design is appropriate for the specific site conditions, will effectively remove turbidity, pathogens, and algae toxins to prevent adverse impacts.

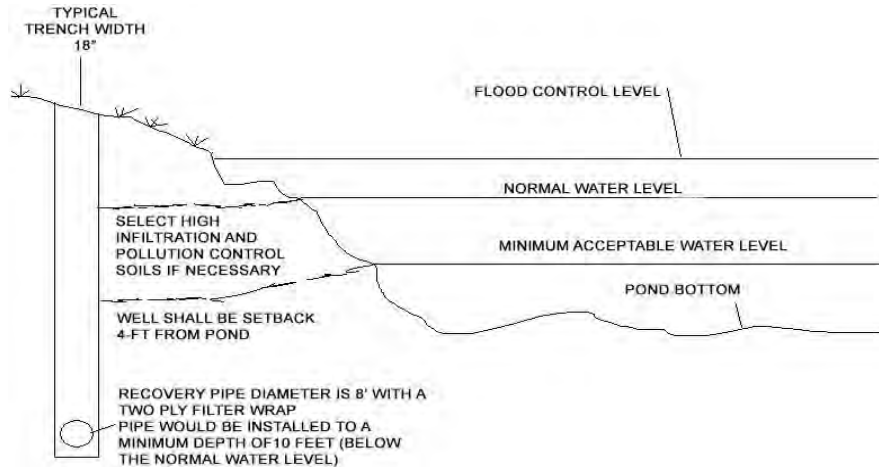

Figure 4.9.2. Schematic for a Typical Stormwater Harvesting Pond (from FDOT BD 521-03, Regional Stormwater Facilities, December 2007).

- (e) **Acceptable Use Rates of Harvested Stormwater** - In addition to water quality considerations, stormwater harvesting systems will be designed and operated in such a manner to prevent adverse impacts to wetlands or surface waters. A common application of the treated stormwater involves an area to be irrigated. For instance, an apartment complex may irrigate natural vegetation, turf grass, and other landscaped common areas. The average yearly demand of turf grass irrigation systems in Florida is usually less than one inch per week on the average over a year. The designer will consult a landscape irrigation specialist for the design of the irrigation system and the recommended irrigation rates. Applicants are advised that a WUP or CUP may be required for stormwater harvesting systems and that the use rates and design will be consistent with WUP or CUP requirements.
- (f) **Rate of Use and Metering of the Harvested Stormwater** - The rate of use (R) is a variable over time and must be recorded. On the REV curves, the rate of use units is expressed as an average inches per day over the EIA. The values can be converted to more practical units such as gallons per day or acre feet per week using simple conversions. The use rate is monitored by a meter or other reporting device. The records of use must be documented in a logbook to demonstrate that the required pollutant load reductions (achieved through reduced volume of discharge) are being met.

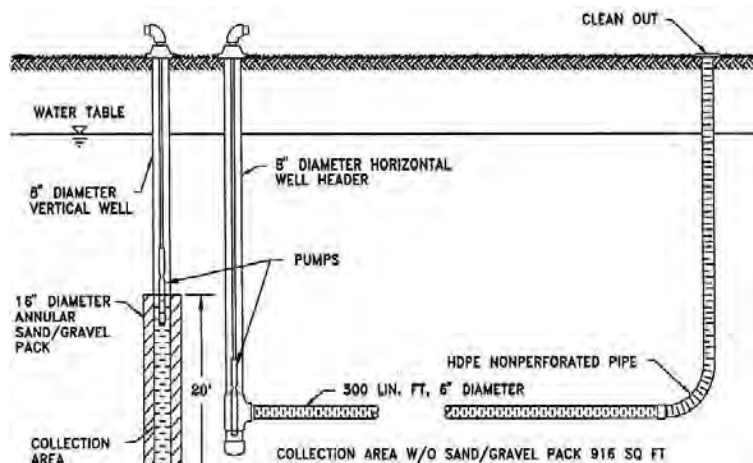

Figure 4.9.3. Example Schematic for Stormwater Harvesting Withdrawal System.

4.9.5. Construction requirements

Stormwater harvesting systems typically are used in conjunction with wet detention basins. Therefore, the first step in constructing a stormwater harvesting system is to construct the wet detention basin in compliance with all permitted design specifications. To assure proper construction of the stormwater harvesting system the following construction procedures are required:

- (a) Construct the wet detention basins following the requirements in Section 4.8.6. of this Manual.
- (b) Construct the stormwater harvesting system and the associated irrigation system in accordance with all permitted design specifications and irrigation system design standards.
- (c) Assure that all irrigation components are properly sited and that irrigation spray heads are working properly and not spraying irrigation water onto impervious areas.

4.9.6. Inspections, Operation and Maintenance

Maintenance issues associated with stormwater harvesting systems are related to the proper functioning of the horizontal well or filter system and of the pump and irrigation system. Stormwater harvesting systems must be inspected regularly by the operation and maintenance entity to determine if it is operating as designed and permitted. Reports documenting the results of annual inspections will be filed with the County every two years.

(a) Inspection Items:

(1)	Inspect operation of the stormwater harvesting system to assure that the pump, flow meter, and filter system are operating properly and achieving desired flow volumes.
(2)	Inspect the operation of the stormwater harvesting system to assure proper operational and, with respect to the irrigation system, inspect the pump, timer, distribution lines, and sprinkler heads to assure they are working properly.

(b) Maintenance Activities As-Needed to Prolong Service:

(1)	Repair any components of the stormwater harvesting system which are not functioning properly and restore proper flow and filtration of stormwater.
(2)	Repair or replace any damaged components of the stormwater harvesting and irrigation system as needed for proper operation.

(c) Record keeping

The owner/operator of a stormwater harvesting system must keep a maintenance log of activities which is available at any time for inspection or recertification purposes. The log will include records related to the operation of the stormwater harvesting system and the use of the harvested stormwater for irrigation or other approved purposes to demonstrate that the permitted nutrient load reduction is being achieved. A totalizing flow meter to measure the quantity and day/time of pumping and irrigation is required. The maintenance log will include the following:

- (1) Stormwater volume harvested using a flow meter specifying the day, time, and volume,
- (2) Stormwater volume irrigated or otherwise used using a flow meter specifying the day, time, and volume used,

- (3) Observations of the stormwater harvesting system operation, maintenance, and a list of parts that were replaced,
- (4) Observations of the irrigation system operation, maintenance, and a list of parts that were replaced, and
- (5) Dates on which the stormwater harvesting and irrigation (or other use systems) were inspected and maintenance activities conducted.

4.9.7. Rate-Efficiency-Volume (REV) Curves

The REV curves relate the use rate (R), the yearly discharge volume average efficiency (E), and the runoff storage volume (V) of the pond. The curves reflect several use efficiencies and track the appropriate combinations of use rates and runoff storage volumes to attain the effectiveness. Information concerning any two of these three variables is necessary for the determination of the third.

The REV curves are generalized for application to watersheds of any size and runoff coefficient via the *EIA*. The units of both the proposed use rate and runoff storage volume are based on the *EIA*. The proposed use rate is the depth of use multiplied by an area, thus it is a volume term.

An individual REV chart is specific to the five meteorological regions of the State used in this Manual. The designer will use the REV chart closest to the project site and within the meteorological zone for design. Each REV chart is composed of REV curves and each curve is specific for an average annual effectiveness. The REV chart for Pinellas County is shown on Figure 4.9.4.

On every REV chart there is a curve for each of the following efficiency levels (in percentage): 20, 30, 40, 50, 60, 70, 80, and 90. Extrapolation between effectiveness lines for a given runoff storage volume on a linear basis is considered reasonable. The range of the curves is restricted by practical applicability and the limits of the simulation variables. The boundaries of the daily data simulation are such that the use rate is limited to no more than 0.50 inches per day over the *EIA* and the runoff storage volumes are no less than 0.25 inches and no greater than 6 inches over the *EIA*. There are marginal returns on efficiencies beyond some maximum runoff storage volume, thus the curves are only produced where there is a marginal change in effectiveness that is within the measurement accuracy. For example, at low average annual effectiveness (e.g., 20%), the effectiveness does not change with added runoff storage volume greater than about 2.5 inches.

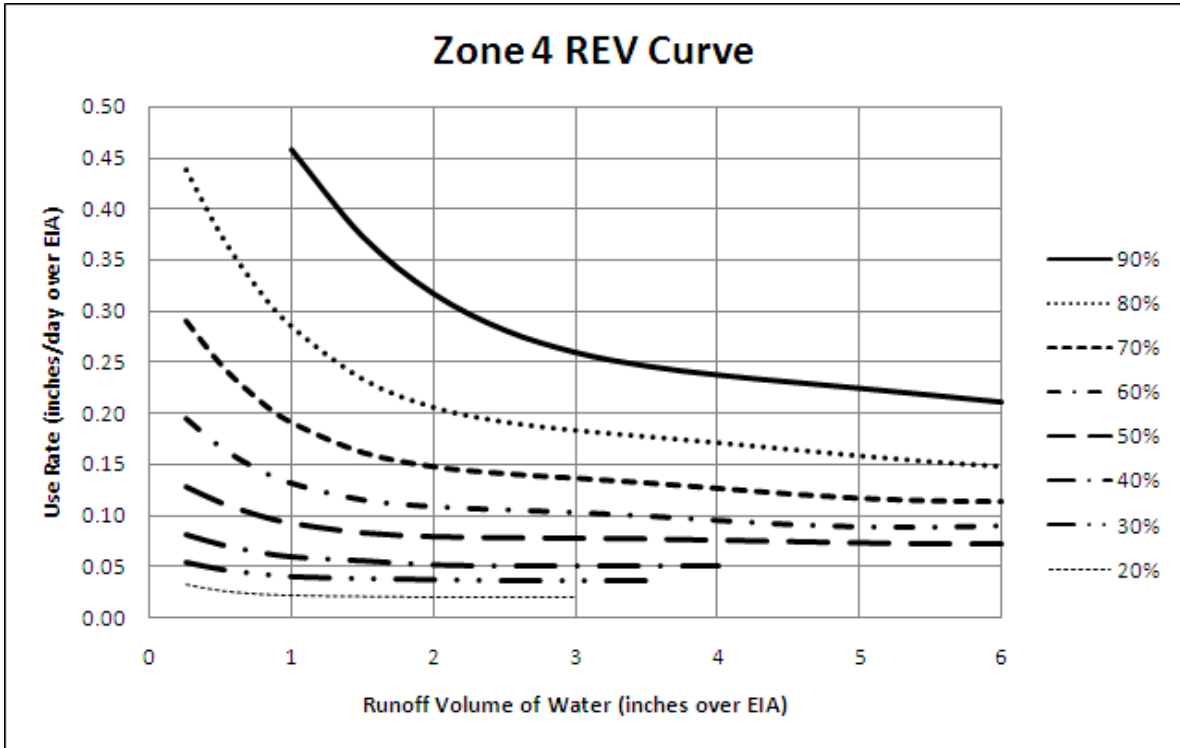

Figure 4.9.4. REV Curve for Meteorological Region 4.

4.10. Up-Flow Filter Systems

4.10.1. Description

Up-flow filters are used in conjunction with detention systems, either wet detention or vault systems, to increase their pollutant load removal effectiveness (Figures 4.10.1). As the name implies, stormwater enters the bottom of these filters and exits from the top. The value of this flow direction is the filter has a lower potential to plug with debris and particulates.

Up-flow filters are very suitable and applicable to ultra-urban redevelopment applications because of their capability to remove significant levels of sediments, particulate-bound pollutants (metals, phosphorus and nitrogen) and organics (oil and grease). They are amenable to ultra-urban constraints such as linear configurations and underground installations.

The up-flow filter contains media to remove either sediments and both particulate and dissolved pollutants. Using a sorption media in the filter increases the removal of dissolved pollutants. There are two categories for up-flow media filtration defined in this Manual, namely:

- Sand filter systems, and
- Mixed media systems.

A sand up-flow filter is composed of graded sand and is usually two-to-four feet deep. The sand media removes most particulates of a certain size. Locally available sandy media are preferred but some designs specify the sand particle-size distribution. A summary of early designs and performance is available in a government fact sheet (EPA, 2008). Normally, the sand particle-size distribution is not difficult to achieve. Example areas where sand filters are used, regulated and recommended for use are California (Caltrans, 2004), Austin Texas (2012), Massachusetts (Mass Highway, 2004), and Delaware (www.deldot.gov). Sand filters are not effective in removing nutrients, especially nitrogen.

For mixed media up-flow filters, there are at least two different types of media that when used together achieve specified pollutant removal effectiveness. Media mixtures that are effective for removing a wide range of pollutant types are sand/clay with other additions (Woelkers et al., 2006), and expanded clay with other media (Ryan et al., 2009, Hardin et al., 2012). Some mixes target specific pollutants, such as used by the Washington State DOT whose mix targets dissolved metals (WSDOT, 2008), and media mixes that target phosphorus (Ma et al., 2009), nitrate (Kim et al., 2003), phosphorus and nitrogen (O'Reilly et al., 2012), organics (Milesi et al., 2006), and metals and dioxins (Pitt and Clark, 2010). Thus, a wide selection of media mixtures can be used for media filtration systems (Chang et al., 2010).

Most mixed media can treat stormwater, wastewater, groundwater, landfill leachate, and sources of drinking water for nutrient removal via physicochemical and microbiological processes (Chang et al., 2010). Media is often composed of materials such as: compost, clay, zeolite, wheat straw, newspaper, sand, limestone, expanded clay, wood chips, wood fibers, mulch, pumice, bentonite, tire crumb, expanded shale, oyster shell, coconut coir, and soy meal hull (Wanielista and Chang, 2008). This document, entitled *Alternative Stormwater Sorption Media for the Control of Nutrients*, was prepared for the SWFWMD and is available online at:

- <http://stormwater.ucf.edu/wp-content/uploads/2014/09/AlternativeMedia2008.pdf>

Media to be used on projects in Pinellas County must meet the requirements contained in the Bioretention Media Supplemental Specification in APPENDIX I of this manual.

UP-FLOW FILTER SYSTEM SUMMARY

Advantages/Benefits	Used to increase the treatment effectiveness of detention systems; applicable to ultra-urban developments and constraints such as linear configurations or underground installations.
Disadvantages/Limitations	Requires a flow meter and filtration system; filter system needs regular inspection and maintenance to avoid clogging and ensure continued operation.
Volume Reduction Potential	Low
Pollutant Removal Potential	Moderate for all pollutants
Key design considerations	Use at the discharge end of a detention system; must have flow diverter for high flows to bypass system; typical filtration rate of 20"/hr; filtration media mixes available for different pollutants; at least 30" deep filter system; must have bottom wet with anoxic conditions to remove nitrogen; replacement of filter media on regular basis.

4.10.2. Treatment required

The required nutrient load reduction will be determined by type of water body to which the stormwater system discharges and the associated performance standard as set forth in **Section 3.1.1.** of this Manual. The Up-Flow Filter will be used as part of a BMP Treatment Train with a detention system.

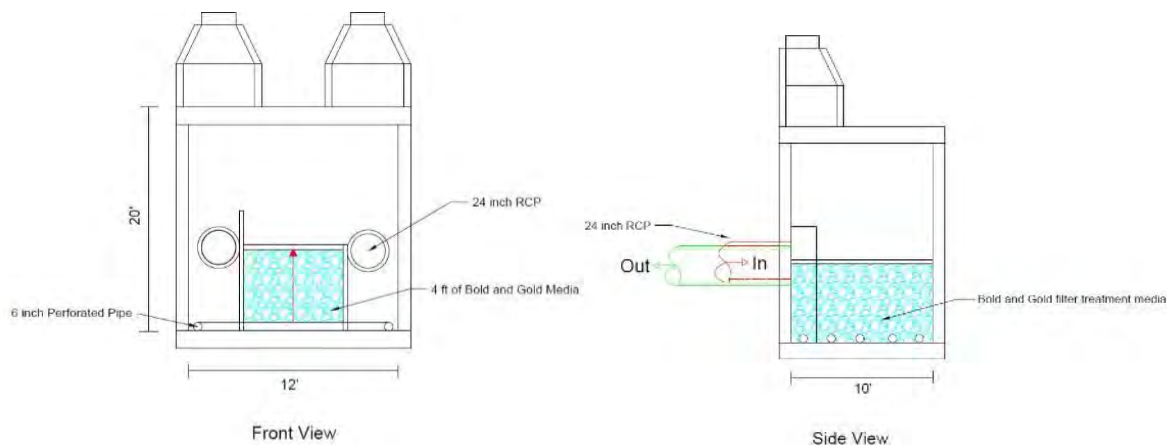

Figure 4.10.1. Front and Side Views of an Off-line Up-Flow Filter.



4.10.3. Expected Load Reduction

The expected pollutant load reduction from an Up-Flow Filter System is dependent on the volume of water directed through the filter and the media within the filter. Each design parameter is specified by the designer and the treatment effectiveness can be determined using the [BMPTrains](#), ICPR version 4, or equivalent software.

The volume of water is expressed as inches captured over the watershed. The inches captured is used to determine the average annual removal capture volume for the meteorological zone in which the project is located as well as the watershed runoff characteristics. Select the treatment volume and then use Table 6.10.5. to determine the annual percentage of stormwater that is captured.

However, unlike retention systems that provide full pollutant load reduction for the treatment volume being infiltrated, filter media only remove a fraction of the nitrogen and phosphorus. The fraction on nutrients removed is showed for five most frequently used media in Table 4.10.1.

When the up-flow filter is bypassed, the stormwater treatment is equal to the effectiveness of the vault or the wet detention pond. When stormwater flows through the up-flow filter the removal is calculated considering a treatment train approach. Removal is the sum of the first treatment (vault or wet detention pond) plus the removal from the filter. The up-flow filter % removal of Table 4.10.1 is applied to the nutrient concentrations remaining after the vault or wet pond effectiveness.

To illustrate the value of the Up-Flow Filter System media for increasing TN and TP removal, consider the following example. A wet detention pond for a County development is designed for an average residence time of 21 days. The effectiveness of the wet pond for TN removal is 36.2% and TP is 61.5% (see Section 4.8.4). Adding an up-flow filter with B&G DOT filter media provides 45% removal of TN and TP during filter operation (Table 4.10.1). If 1.5 inches of the water in the wet detention pond (treatment volume in this case) is directed through the up-flow filter, then the annual TN and TP treatment effectiveness of the B&GDOT filter and the wet pond is increased to 50% and 74% respectively. If a slower rate of filtration is used with B&G CTS media, the annual TN effectiveness increases to 70% and annual average TP removal increases to 90% (see BMPTAINS for calculations).



4.10.4. Design Criteria

1. Use of the Up-Flow Filter system after wet detention or after a vault at the end of pipe must include a provision to bypass stormwater when the flow is in excess of the treatment rate. The treatment rate is expressed as inches over the watershed. The percentage of bypass is used to calculate the annual effectiveness.
2. Use a diversion structure to direct the treatment volume into the Up-Flow Filter and to bypass higher flows into a downstream conveyance system.
3. The design rate of filtration for up-flow filters is greater than or equal to 20 inches/hour because of cost and space constraints. Slower rates can be used especially if effectiveness increases. Table 4.10.1. shows the filtration rates in common use and those necessary to achieve the desired effectiveness when using the media of Table 4.10.1. Additional details for design rates are found in ["Demonstration Bio Media for Ultra-urban Stormwater Treatment", Wanielista, et. al.\(2014\).](#)

Also, when using the [BMPTRAINS](#) model, user defined media data may be entered into the program.

4. The depth of an up-flow filter is at least 30 inches. This depth typically allows for the residence time necessary to remove nutrients. For nitrogen removal, the up-flow filter must remain wet. A wet condition is not necessary if phosphorus removal is only needed.
5. For phosphorus removal using biosorption activated media (BAM), such as the media listed in Table 4.10.1, the design rate of ortho-phosphate (OP) removal is 0.25 mg of OP/gram of media. This rate is used to determine the replacement or maintenance time for the filter. Typically, maintenance or replacement times are set at greater than two years. Even though particulate matter is removed by the Up-Flow Filter most of the particulate matter is removed by sedimentation in the pre-treatment area of a vault or within the wet detention pond. There are numerous types of BAM from various manufacturers. The requirements for approval to use a particular BAM mixture are contained in the BAM specification in the appendices of this manual.

A typical schematic of an Up-Flow Filter system used at the discharge of a wet detention system or detention vault are shown in Figures 4.10.2 and 4.10.3.

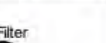
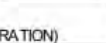
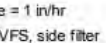
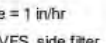
DESCRIPTION OF MEDIA	MATERIAL	PROJECTED TREATMENT PERFORMANCE *			TYPICAL OPERATING LIMITING FILTRATION RATE (in/hr)
		TSS REMOVAL EFFICIENCY	TN REMOVAL EFFICIENCY	TP REMOVAL** EFFICIENCY	
B&G ECT³ (ref A) Follow s a BMP Stand alone first BMP 	Tire Chips ¹ Expanded Clay ²	60% 70%	25% 45%	25% 45%	96 in/hr
IFGEM⁶ (ref B) down flow or upflow filters pervious pave, tree well, rain garden, swale, VFS, side filter 	Iron ⁸ Tire Crumb ⁵ Clay ⁷ and Sand ⁷	95%	80%	95%	5 in/hr
B&G ECT³ (ref C) After Wet Detention using Up-flow Filter Stand alone first BMP 	Expanded Clay ⁴ Tire Chip ¹	60% 70%	25% 45%	25% 45%	96 in/hr
SAT³ (ref D) A first BMP, as a Down-flow Filter (FILTRATION) 	Sand ³	85%	30%	45%	2 in/hr
B&G CTS⁶ (ref E,F) Bottom of dry basin 12" depth*** use rate = 1 in/hr pervious pave, tree well, rain garden, swale, VFS, side filter 	Clay ⁶ Tire Crumb ⁵ Sand ⁷ & Topsoil ⁹	90%	60%	90%	5 in/hr
B&G CTS⁶ (ref E,F) Bottom of dry basin 24" depth*** use rate = 1 in/hr pervious pave, tree well, rain garden, swale, VFS, side filter 	Clay ⁶ Tire Crumb ⁵ Sand ⁷ & Topsoil ⁹	95%	75%	95%	5 in/hr

NOTES ^ANo generally accepted BMP at this time. Also can be used as a downstream BMP but the removal must be lowered.
^{*}All Effectiveness Estimates to nearest 5%; ^{**}Phosphorus removal has limited life expectancy; ^{***}24" depth has TN and TP removals of 75 & 95%
 acronyms B&G - BOLD & GOLD; SAT - Sand Austin Tx; ECT- Expanded Clay and Tire; ECT3 Expanded Clay and Tire in Treatment Train
¹ Tire Chip 3/8" and no measurable metal content (approximate dry density = 730 lbs/CY)
² Expanded Clay 5/8 and 3/8 blend (approximate dry density = 950 lbs/CY)
³ Sand ASTM C-33 with no more than 3% passing # 200 sieve (approximate dry density = 2200 lbs/CY)
⁴ Expanded Clay 3/8 in blend (approximate density = 950 lbs/CY)
⁵ Tire Crumb 1-5 mm and no measurable metal content (approximate density = 730 lbs/CY)
⁶ Medium Plasticity typically light colored Clay (approximate density = 2500 lbs/CY)
⁷ Sand with less than 5% passing #200 sieve (approximate density = 2200 lbs/CY)
⁸ Iron Filings 110-140 pounds/cubic foot, 4-6% by volume
⁹ Local top soil is used over CTS media in dry basins, gardens, swales and strips, is free of roots & debris but is not used in other BMPs.

A - Demonstration Bio Media for Ultra-urban Stormwater Treatment, Waniellista, et.al. FDOT Project BDK78 977-19, 2014
 B - Optimal Recipe Assessment of Iron-Filling Based..., Valencia, et.al., Environmental Engineering Science, 36, 10, 2019
 C - Up-Flow Filtration for Wet Detention Ponds, Waniellista and Flint, Florida Stormwater Association, June 12, 2014.
 D - City of Austin Environmental Criteria Manual, Section 1.6.5, Texas, 2012
 E - Nitrogen Transport and Transformation in Retention Basins, Marion Co, Fl, Waniellista, et al, State DEP, 2011
 F - Improving Nitrogen Efficiencies in Dry Ponds, Williams and Waniellista, Florida Stormwater Association, June 18 2015

Table 4.10.1. Filter Media Example Types and Removal Effectiveness. <http://roneaglin.online/BMPTrainsDocumentation/MediaMixes.pdf>

The B&G DOT up-flow filter media is used after storage in a vault at the end of a pipe. The effectiveness assumes that there is an annual residence time of at least 10 minutes and a screening for debris before the up-flow filter. The B&G OTE and the B&G CT up-flow filter media are used after a wet detention pond designed for an annual residence time of at least 21 days. The Austin Texas Sand Filter and Marion County Florida retention media are also shown in Table 4.10.1. The Marion County media has been used for infiltration BMPs where there is a need to protect groundwater from nutrients that may infiltrate into the groundwater.

4.10.5. Construction considerations

Typical components of an Up-Flow Filter system are detention systems, collection and filtration structures, pretreatment areas to remove gross solids, the media filtration bed itself, effluent collection systems and discharge structures to downstream conveyances or surface water outfalls.

There is no special construction equipment needed other than that commonly used for setting stormwater pipes and excavation. As for any stormwater system, elevation control is needed to establish both the inlet and outlet invert elevations.

Up-Flow Filters typically are used in conjunction with wet detention basins or vaults. Therefore, the first step in constructing an up-flow filter is to construct the wet detention basin or vault in compliance with all permitted design specifications. To assure proper construction of the up-flow filter the following construction procedures are required:

- (a) Construct the wet detention basins or vaults following the requirements in Section 4.8.6. of this Manual.
- (b) Construct the up-flow filter in accordance with all permitted design specifications and the design criteria of this Manual.

A typical schematic of an Up-Flow Filter used at the discharge end of wet detention pond is shown in Figure 4.10.2. A typical schematic of an Up-Flow Filter used at the discharge end of a detention vault is shown in Figure 4.10.3.

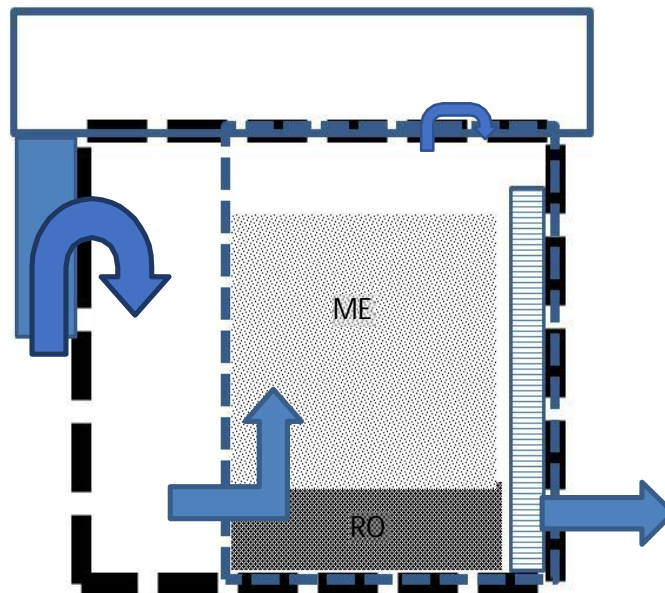

Figure 4.10.2. Typical Schematic of an Up-flow Filter after Wet Detention with Water Flow Direction.

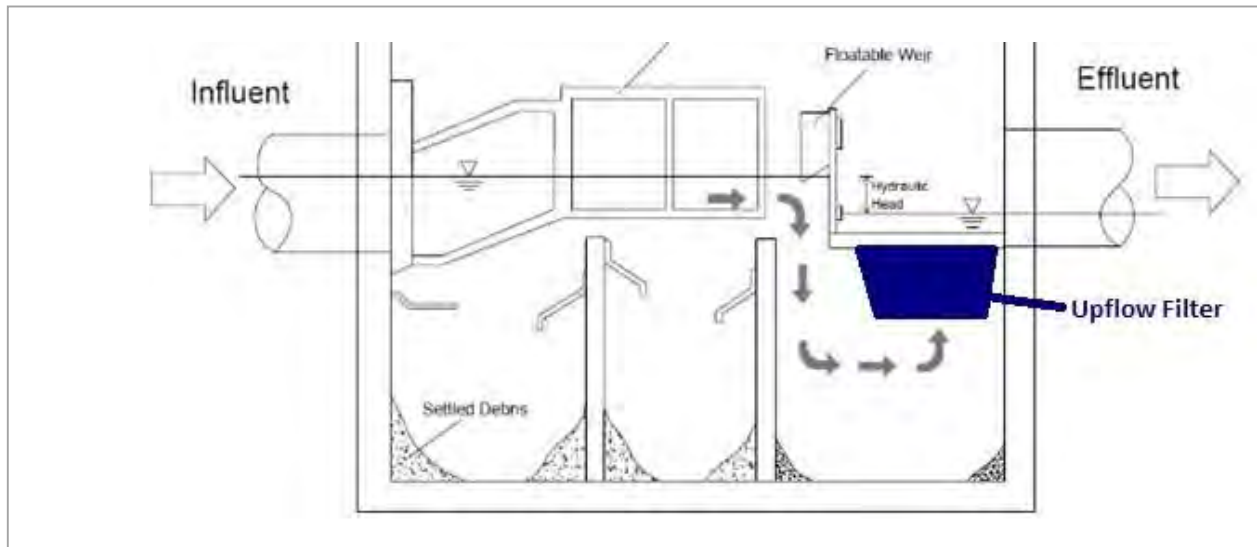

Figure 4.10.3. Typical Schematic of an Up-flow Filter after Vault Detention with Water Flow Direction.

4.10.6. Inspections, Operation and Maintenance

Maintenance issues associated with up-flow media filters are less than with down-flow filters. A pump suction-type evacuator is usually used to remove debris. The same equipment cleans debris and solids from catch basins and sewer lines. In front of a filter, a settling system minimizes solids and debris on the filter. The sedimentation process of the settling system removes heavy solids, debris and floating materials, and reduces the maintenance needed to keep the filter operational. Reports documenting the results of annual inspections will be filed with the County every two years.

(a) Inspection Items:

- (1) Inspect operation of the up-flow filter to assure that water is flowing through the filter.
- (2) Inspect the inlet and outlet structures to assure they are working properly, and no debris impedes operation.

(b) Maintenance Activities As-Needed to Prolong Service:

- (1) Repair any components that are not functioning properly and restore proper flow and filtration of stormwater.
- (2) Repair or replace any damaged components as needed for proper operation.

(c) Record keeping

The owner/operator of an Up-Flow Filter must keep a maintenance log of activities which is available at any time for inspection or recertification purposes. The log will include records related to the operation and maintenance. The maintenance log will include the following:

- (1) An estimate of the stormwater volume passing through the filter in a year;
- (2) Inspection dates and forms
- (3) Maintenance dates and activities including a list of parts that were replaced;

4.11. Managed Aquatic Plant Systems (MAPS)

4.11.1. Description

Managed Aquatic Plant Systems (MAPS) are aquatic plant-based BMPs that remove nutrients through a variety of processes related to nutrient uptake, transformation, and microbial activities. Examples of MAPS include planted littoral zones. In the latter example, harvesting of the biomass is an essential process of the BMP. Accordingly, the use of MAPS will be reviewed and approved on a case-by-case basis based on the operation, maintenance, and management plan proposed.

Generally, wet detention systems alone will not achieve the required levels of nutrient removal from stormwater. In nearly all cases, a BMP treatment train will be required when using a wet detention system. Components of the BMP treatment train include source controls or pretreatment BMPs, such as retention or swales, to reduce either the stormwater volume or nutrient concentrations in stormwater discharged to the wet detention system. However, high water tables and slowly percolating soils do not make infiltration practices practical or effective. Managed Aquatic Plant Systems (MAPS) can be incorporated into a wet detention BMP treatment train to provide additional treatment and nutrient removal after the wet pond has provided reduction of pollutants through settling and other mechanisms that occur within the wet pond.

MANAGED AQUATIC PLANT SYSTEM SUMMARY

Advantages/Benefits	Increases the treatment effectiveness of wet detention systems, especially for nutrients; increases the aesthetics and habitat quality of wet detention systems.
Disadvantages/Limitations	Increases maintenance requirements of wet detention systems; water level fluctuation in wet detention systems often reduces growth of littoral zone plants.
Volume Reduction Potential	None
Pollutant Removal Potential	Low for all pollutants
Key design considerations	Determine if littoral zone will be used; for littoral zones ensure proper slopes and surface water elevations; also determine plant species and planting densities to achieve the required areal extent and plant coverage
Key construction and maintenance considerations	Inspect to ensure plant survival and coverage meet permit requirements and replant as needed; identify nuisance or exotic plants and remove

4.11.2. Nutrient Removal Effectiveness and Credits

The stormwater treatment nutrient removal effectiveness and credits for the different types of MAPS will be based on data obtained from monitoring of these systems in Florida. The nutrient removal credits associated with MAPS will be calculated using the [BMPTRAINS](#) software or the underlying BMP Treatment Train Equations. Table 4.11.1 summarizes the proposed nutrient reduction credits based on the data that is currently available. It is anticipated that more data will become available and included during the rule adoption process.

Table 4.11.1. Nutrient Removal Credits for MAPS

Type of MAPS	TN Removal	TP Removal
Littoral zone	10%	10%



The applicant must provide independent scientific data based on Florida field monitoring to validate the nutrient load reduction of any MAPS proposed for use.

4.11.3. Littoral Zone Design Criteria

Littoral zones are an optional component of wet detention systems. The littoral zone is that portion of a wet detention pond that is designed to contain rooted aquatic plants. The littoral area is usually created by extending and gently sloping the sides of the pond to a maximum depth of four feet below the normal water level or control elevation. One of the difficulties of successful littoral zone establishment and maintenance is the frequent changes in water level elevations within a wet detention pond. Additionally, experience has shown that long-term survival of littoral zones is best when they are not located adjacent to private lots. Consequently, littoral zones typically are located near the outfall of a wet detention pond or along areas with common ownership. Littoral zones should also be considered in other areas of the pond that have depths suitable for successful plant growth such as a shallow shelf between the inflow sumps and the rest of the pond or on a shallow shelf in the middle of the pond, provided maintenance can be undertaken. If treatment credit is proposed for littoral zones placed adjacent to private lots, the applicant will provide additional assurances through their legal operation and maintenance documents or through an easement that the littoral zone will be maintained as permitted.

The littoral zone is established with native plants by planting and/or the placement of wetland soils containing seeds of native plants. A specific vegetation establishment plan must be prepared for the littoral zone. The plan must consider the water elevation fluctuations of the wet detention pond and the ability of specific plants to be established. A list of recommended native plant species suitable for littoral zone planting is included in Table 4.11.2. In addition, a layer of muck soil can be incorporated into the littoral area to promote the establishment of the wetland vegetation. When placing muck, special precautions must be taken to prevent erosion and turbidity problems in the pond and at its discharge point while vegetation is becoming established in the littoral zone.

The following is a list of the design criteria for wet detention littoral zones:

- (a) The littoral zone will be gently sloped (6H:1V or flatter). At least 35 percent of the wet detention pond surface area will consist of a littoral zone. The percentage of littoral zone is based on the ratio of vegetated littoral zone to surface area of the pond at the control elevation.
- (b) The bleed-down volume should not cause the pond level to rise more than 18 inches above the control elevation unless the applicant affirmatively demonstrates that the littoral zone vegetation can survive at greater depths.
- (c) Within 24 months of completion of the system, 80 percent coverage of the littoral zone area by suitable aquatic plants is required with no more than ten percent consisting of exotic or nuisance species such as cattails or primrose willow.
- (d) Planting of the littoral zone is required to meet the 80% coverage requirement. As an alternative to planting, portions of the littoral zone may be established by placement of wetland top soils (at least a four-inch depth) containing a seed source of desirable native plants. When using this alternative, the littoral zone must be stabilized by mulching (non-floating) or other means and at least the portion of the littoral zone within 25 feet of the inlet and outlet structures must be planted. In addition, monitoring of plants will be done quarterly to ensure that the 80% coverage requirement is met within one year.
- (e) In parts of Florida, the Channeled Apple Snail has been shown to decimate littoral zone vegetation so designers need to be aware of this problem and will be required to provide additional assurances that damage done to the vegetation will be repaired within one month.

- (f) Replanting will be required if the percentage of vegetative cover falls below the permitted level. The native vegetation within the littoral zone will be maintained as part of the system's operation, maintenance, and management plan. Undesirable species such as cattail and other exotic or nuisance plants will be controlled and removed as needed.
- (g) An operation, maintenance, and management plan that specifies the schedule for inspections and the maintenance and management activities that will be done will be provided.

Table 4.11.2. Native Plant Species Suitable for Littoral Zone Plantings or Adjacent to Wet Detention Ponds

SCIENTIFIC NAME	COMMON NAME	PLANTING ZONE *	FEATURES
FRESHWATER WOODY SPECIES (trees, shrubs, and palms)			
<i>Acer rubrum</i>	Red maple	1-2	Medium sized tree specimen known for its attractive brilliant red fall color
<i>Carpinus caroliniana</i>	American hornbeam "Blue Beech"	1	Medium sized tree with attractive bark, and interesting form.
<i>Carya aquatica</i>	Water hickory	1-2	Large tree with large leaves. Fall color (bright yellow)
<i>Cephalanthus occidentalis</i>	Buttonbush	1-2	Large shrub up to 10 ft tall with white flowers resembling buttons. Buttonbush has a scrubby appearance owing to the dying of leader shoots leaving dead stumps.
<i>Clethra alnifolia</i>	Sweet pepper bush	2	Highlighter, shrub with attractive berries
<i>Crataegus marshallii</i>	Parsley hawthorn	1	showy, white flowers and red fruits are good wildlife food
<i>Fraxinus caroliniana</i>	Popash	1-2	Large specimen with attractive foliage and deep furrowed bark
<i>Gordonia lasianthus</i>	Loblolly bay	1-2	Medium to large tree. Large white flowers and attractive foliage
<i>Hypericum</i> spp.	St. John's Wort	2	Highlighter, shrub
<i>Ilex cassine</i>	Dahoon holly	1	Small tree or shrub with prominent red berries and attractive evergreen foliage
<i>Ilex vomitoria</i>	Yaupon holly	1	General landscape shrub with attractive red berries.
<i>Liquidambar styraciflua</i>	Sweetgum	1-2	Medium to large specimen. Attractive unusual shaped foliage and good fall color. Not tolerant of long-term inundation
<i>Magnolia virginiana</i>	Sweet bay	1	Medium sized tree with attractive foliage and white flowers.
<i>Myrica cerifera</i>	Wax myrtle	1	Large shrub with attractive aromatic evergreen foliage. Bluish green berries in autumn and winter are eaten by many birds. Often used in groups for

SCIENTIFIC NAME	COMMON NAME	PLANTING ZONE *	FEATURES
			general landscaping and high lighting or accent around ponds.
<i>Nyssa biflora</i>	Blackgum tupelo	1-2	Glossy foliage turning bright red in autumn. Fruit matures in the fall; is consumed by many birds. Flowers are a source for honey.
<i>Persea palustris</i>	Swamp redbay	1-2	Attractive aromatic glossy green foliage. Bitter fruit is eaten by wildlife. Does not do well in submerged locations.
<i>Quercus laurifolia</i>	Laurel oak	1	Large tree with attractive nearly evergreen foliage. Acorns eaten by wildlife.
<i>Quercus nigra</i>	Water oak	1	Large deciduous tree with small fine textured foliage. Acorns provide food for wildlife.
<i>Rhapidophyllum hystrix</i>	Needle palm	1	Small to medium sized palm with attractive foliage used for providing tropical highlights. Sharp needles along the trunk lead to its name
<i>Sabal palmetto</i>	Cabbage palm	1	Large palm suited to all areas. Attractive tropical fan shaped foliage.
<i>Taxodium</i> spp.	Bald or Pond Cypress	1-2	Large aquatic deciduous conifer of picturesque form. Preliminary observation shows good survival and rapid growth of either species when used for stormwater enhancement purposes.
<u>FRESHWATER HERBACEOUS SPECIES (herbs, sedges, grasses, and ferns)</u>			
<i>Bacopa caroliniana</i>	Lemon bacopa "Water hyssops"	2	Crushed leaves and stems lemon scented. Flowers blue.
<i>Canna flaccida</i>	Golden canna "Canna lily"	2	Very good highlighter. Used on fringe of ponds and lakes. Large showy yellow flowers.
<i>Cladium jamaicense</i>	Saw-grass	1-2	Coarse perennial sedge up to ten feet tall. Grows equally well in water or several feet above water level. Long narrow and serrated leaf blades. Provides nesting, protection and food (seeds) for water fowl and other birds.
<i>Coreopsis leavenworthii</i>	Tickseed	2	Perennial herb w/ attractive yellow flowers. Prefers soil at edge of ponds or lakes
<i>Crinum americanum</i>	Swamp lily	2	Good highlighter at pond fringes. Showy white fragrant flowers. Stems usually less than waist high.
<i>Cyperus odoratus</i>	Umbrella sedge	1-2	Good accent plant usually grown in clumps on edge of ponds. Does well in areas of fluctuating water but also in more upland areas. Its stems are usually less than three feet tall with a conspicuous umbrella shaped foliage and brown seed head

Table 4.11.2. Native Plant Species Suitable for Littoral Zone Plantings or Adjacent to Wet Detention Ponds

SCIENTIFIC NAME	COMMON NAME	PLANTING ZONE *	FEATURES
<i>Diodia virginiana</i>	Buttonweed	1-2	Does well in wet soils along the border of ponds. Relatively low growing perennial herb. Small white flowers between leaves and stem. Does not prefer submerged conditions.
<i>Dryopteris ludoviciana</i>	Southern shield Leatherleaf fern	1-2	Suited to wet soils in the zone of fluctuation above the permanent pool
<i>Echinochloa crusgalli</i>	Barnyard grass "wild millet"	1-2	Best suited for edges of ponds and lakes. Steps up to four feet tall. Seeds used by waterfowl and songbirds
<i>Eleocharis</i> spp.	Spikerushes	1-2	Suitable for establishing marshes along the coast. Slender, dwarf, and water spikerushes may be submerged. Other varieties grow along the landward edge of ponds. May be grown in clumps or as colonies depending on species
<i>Eriocaulon decangulare</i>	Hat pins	2	Low growing plant with slender spikes. Top is tipped with a small white "button". Provides good contrast with wetland grasses or sedges
<i>Hibiscus</i> spp.	Marsh hibiscus	1-2	Normally used for accent on the edge of ponds. Large flowers 4-8 inches in diameter.
<i>Hydrocotyle umbellata</i>	Water pennywort	2	Numerous round partly to deeply lobed leaves centrally attached to a stem up to 12 inches long. Grows well on the surface of the water or as a ground cover rooted along the edge of ponds
<i>Hymenocallis</i> spp.	Spider lilies	1-2	Provides good ground cover, used for accent on the edge of ponds. Showy white flowers. Best on wet soils.
<i>Iris virginica</i>	Anglepod blue flag iris	2	Prefers wet soils at the fringes of lakes and ponds. Average height of one foot. With blue flowers. Used for highlighting, planted in groups at the edges of wetlands or ponds.
<i>Iris irginicus</i>	Southern blue flag iris	2	Prefers habitats similar to "angelpod". More upright grower. Flowers last for several weeks in spring
<i>Juncus effusus</i>	Soft rush	2	Very attractive with pale green hollow stems up to four feet tall. Commonly used in large clumps along the edge of lakes or ponds. Seeds used by waterfowl. Does not die back in winter making it a good plant for wet detention ponds where it is planted in clumps
<i>Nelumbo lutea</i>	American lotus	3-4	Attractive, large leafed rooted aquatic. Circular leaves up to 24 inches across with large showy yellow flowers. Planted along the outside of littoral zones in groups spaced about 25 feet apart
<i>Nuphar luteum</i>	Spatterdock	3-4	Water lily with large oval or heart shaped leaves up to 16 inches long and ten inches wide. Small,

Table 4.11.2. Native Plant Species Suitable for Littoral Zone Plantings or Adjacent to Wet Detention Ponds

SCIENTIFIC NAME	COMMON NAME	PLANTING ZONE *	FEATURES
			spherically shaped yellow flowers. Roots provide good habitat for shellcrackers.
<i>Nymphaea mexicana</i>	Yellow water lily	3-4	Similar in form and use as other water lilies. Bright yellow flowers.
<i>Nymphoides aquatica</i>	Floating hearts	2-4	Similar to other water lilies. Short thick roots with a cluster of small white flowers
<i>Osmunda cinnamomea</i>	Cinnamon fern	2	Attractive lush foliage best suited for shaded areas internal to or approaching the periphery of cypress or other wooded wetlands
<i>Osmunda regalis</i>	Royal fern	2	Similar habitat as cinnamon fern. May be used to add a "rain forest" like appearance.
<i>Panicum hemitomon</i>	Maidencane	1-2	A grass that does well in dry soils or submerged in water. Forms dense colonies in wet areas and shallow parts of ponds. Aggressive grower.
<i>Peltandra virginica</i>	Green Arrow arum		Perennial herb with arrow shaped leaves up to waist high. Blades vary in size up to a foot wide and 1.5 feet long
<i>Polygonum spp.</i>	Smartweed	2	An annual or perennial herb with creeping stems that grows along the ground. Stems have spikes of small pink and white flowers. Seeds used by birds, waterfowl, and small mammals
<i>Pontedaria cordata</i>	Pickerelweed	3	One of the most commonly used and attractive plants in littoral zones. Attractive dark green lance shaped leaves with violet blue flowers.
<i>Sagittaria lancifolia</i>	Arrowhead	3	Another of the more common plants used in littoral zones. Has narrow elliptical lance shaped leaves up to two feet in length and four inches wide with small white flowers
<i>Sagittaria latifolia</i>	Broadleaf arrowhead	3	Has deeply lobed and arrow shaped leaves up to one foot long with small white flowers
<i>Scirpus californicus</i>	Giant bulrush	2-3	Has blunt triangular stems up to ten feet tall.
<i>Scirpus validus</i>	Soft stem bulrush	2-3	Has cylindrical stems up to eight feet tall. Attractive brown spikelets with seeds that are eaten by waterfowl and songbirds
<i>Spartina bakeri</i>	Sand cordgrass	1-2	This grass grows in stout and dense clumps. Excellent accent plant on fringes of wet ponds. Has a reddish tinge when flowering.

* Planting Zones:

- 1) + 0.5 feet (or more) higher than the normal level of the permanent pool.
- 2) + 0.5 feet above to -1.0 feet below normal pool.
- 3) - 1.0 feet to - 3.0 feet below the control elevation of the permanent pool.
- 4) - 3.0 feet to - 5.0 feet below normal water level.

4.12. Biofiltration Systems with Biosorption Activated Media (BAM)

4.12.1. Description

Biofilters or [biofiltration](#) systems are a suite of typically offline BMPs that are engineered systems used when soils will not allow adequate percolation for retention systems. Typically, these are stormwater detention BMPs and serve small watershed areas of up to two-acres. Biofiltration systems with BAM incorporate select soils, cellulose, or other pollutant removal mixtures. For the removal of phosphorus, BAM has to display a sorption capacity for phosphorus. For nitrate removal, other properties of the containment should be present such as an anoxic zone. Planted vegetation to facilitate treatment for removal of nutrients is common. The use of BAM will also reduce toxic compounds in the discharge waters.

There are many opportunities for biofiltration systems and many configurations making them highly applicable to urbanized areas undergoing redevelopment or for retrofitting existing urban areas to reduce pollutant loading. Generally, they will have an underdrain and discharge, but in some cases, they may be designed to function as retention systems. Examples include;

- Shallow depressed areas within the landscaping
- Landscape planter boxes
- Tree box filters

The latter two types of biofiltration systems are discussed in more depth in Section 4.12.7. and 4.12.8.

The biofiltration system may be lined to keep it separate from the surrounding water table and to maintain an anoxic zone in the bottom of the system that promotes the Nitrogen Cycle. Separating the biofiltration system from the water table has a number of advantages:

- an artificial anoxic zone is created to facilitate improved nitrogen removal.
- the permanently wet zone serves as a source of water for plants within the biofiltration system. The plant root zone must be able to tolerate being wet most of the time. Some BAM mixes retain a residual moisture content and do not have to be resident in a permanently wet zone.
- the underdrain system is not permitted to drain ground water, which can contribute significant nutrient loads to the surface water system. This allows biofiltration systems to be used where the SHGWT table is within two feet of land surface.
- the system can be used where there may be concerns about contamination of ground water, such as gas stations.
- the system can be used adjacent to structures that may be adversely impacted by ground water, such as building foundations and road foundations.

The major components of a biofiltration system include:

- Pretreatment area (optional) – sediment and trash pre-treatment BMPs, vegetated buffers, or swales commonly used
- Ponding area – typically limited to a depth of 6 to 12 inches
- Ground cover layer and plants – 2 to 6 inches of top soil planted with [Florida-friendly™](#) plants
- Planting/filtration media (i.e., engineered soil and/or BAM) – Varies depending on purpose (porosity vs. filtration)
- Inlet and outlet controls – non-erosive inflows and underdrain outflow

As is customary with green infrastructure principles, numerous biofiltration systems distributed throughout a catchment instead of a single large stormwater basin help facilitate treatment near the source. This can reduce total land needed for stormwater management and reduce project costs. Although any one treatment area may be small, the cumulative effect of multiple systems can be significant.

BIOFILTRATION SYSTEM SUMMARY

Advantages/Benefits	Applicable to small watershed areas; applicable to high SHGWT conditions; applicable to highly urban areas with land limitations; applicable to retrofitting urban properties; can be designed as an aesthetic amenity.
Disadvantages/Limitations	Requires underdrain system, filter media mixture, and landscaping.
Volume Reduction Potential	Low
Pollutant Removal Potential	Moderate for all pollutants
Key design considerations	Contributing watershed area under two-acres; separate from SHGWT by structural methods; at least two inches of top soil or mulch (non-floating), appropriate depth of planting soil, and 24 inches of filter media with a carbon source; must be able to discharge in an appropriate conveyance system
Key construction and maintenance considerations	Inspect inflow/outflow points for any clogging; inspect pre-treatment BMPs for clogging; inspect prefilter strip vegetated buffer/grass swale and ponding area for erosion or gully; inspect trees and shrubs to evaluate their health; inspect the underdrain system to ensure it is not clogged; test planting soil pH every three years to ensure between 5.5 and 6.5; if infiltration based, test infiltration rate with double ring infiltrometer every three years.

4.12.2. Biosorption Activated Media (BAM)

Sorption media with mixes containing recycled materials, such as cellulose and tire crumb, combined with natural soils such as sand/silt/clay, some composts, and limestone, are recommended for nutrient removal in stormwater management systems, including biofilters, upflow filters, and retention BMPs. Media for biofilters are targeted at removing a wide range of pollutants from nutrients to heavy metals. Some media for use in retention BMPs are targeted at facilitating the Nitrogen Cycle to minimize the production of nitrates and nitrate loading to the ground water.

Since the water quality focus in Florida is on reducing nutrient loadings to surface and ground waters, for additional information the stormwater designer is referred to the publication entitled “Alternative Stormwater Sorption Media for the Control of Nutrients” prepared by the UCF Stormwater Management Academy for the SWFWMD. This publication is available online at:

<http://stormwater.ucf.edu/wp-content/uploads/2014/09/AlternativeMedia2008.pdf>

Please note that not all of the materials listed in the publication referenced above will be suitable for use in project within Pinellas County. For acceptable BAM media composition and technical requirements, see the Bioretention Media Supplemental Specification in the APPENDIX I of this manual.

4.12.3. Applicability

1. Water quantity control

Biofiltration systems are designed primarily as BMPs for addressing stormwater quality. Although biofiltration systems will provide some attenuation of peak flows, they will most likely not provide sufficient storage capacity to meet County or SWFWMD water quantity control criteria (as written in

2. Water quality control

Biofiltration systems use the chemical, biological, and physical properties of plants, microbes, and soils or engineered media (BAM) to remove stormwater pollutants. Treating stormwater by biofiltration can be very effective due to the variety of chemical, physical, and biological removal mechanisms.

Biofilters may be especially useful in highly urban areas where land for wet detention systems is scarce, and soils are inappropriate for retention systems. Biofilters may be especially useful in highly urban areas where land for retention or wet detention systems is scarce, and soils are inappropriate for retention systems. For example, roof runoff can be effectively detained and treated in a containerized biofilters such as a planter box. Parking lot runoff can be routed into shallow depressed landscape islands with curb cuts or into biofilters integrated into the landscaping adjacent to the parking lot. Figures 4.12.1. through 4.12.5. provide illustrations of the several types of biofiltration systems.

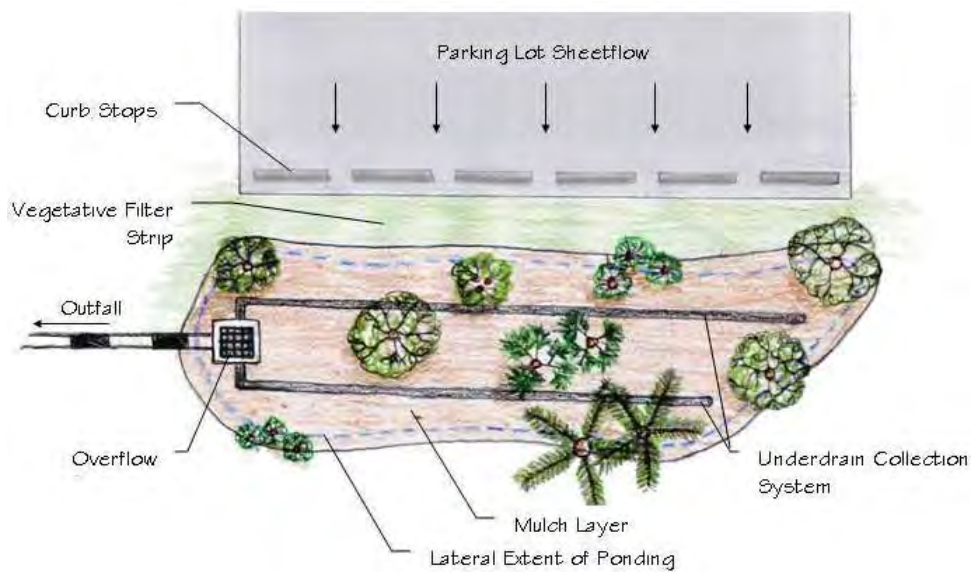

Figure 4.12.1. Plan View Illustrating a Biofiltration System.

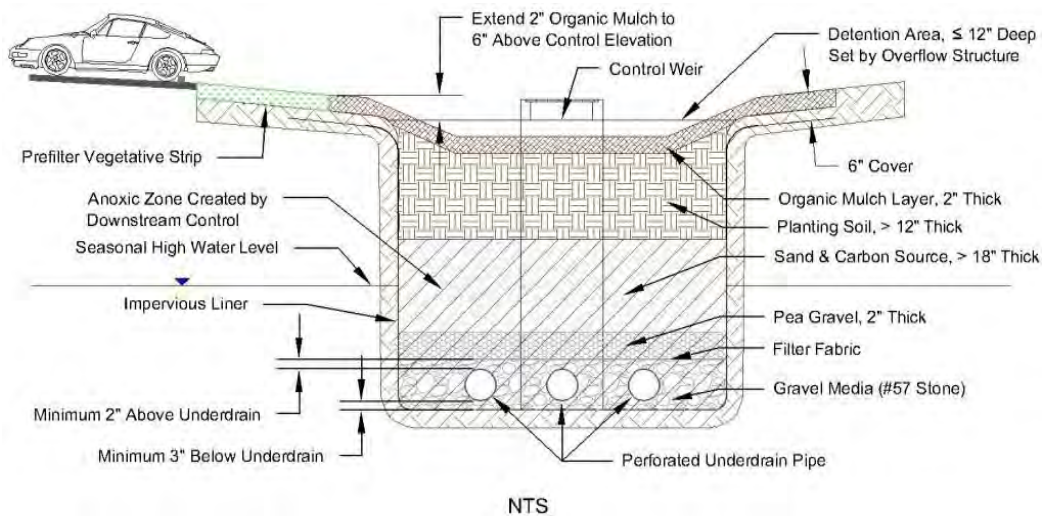

Figure 4.12.2. Cross Section View of a Biofiltration System.

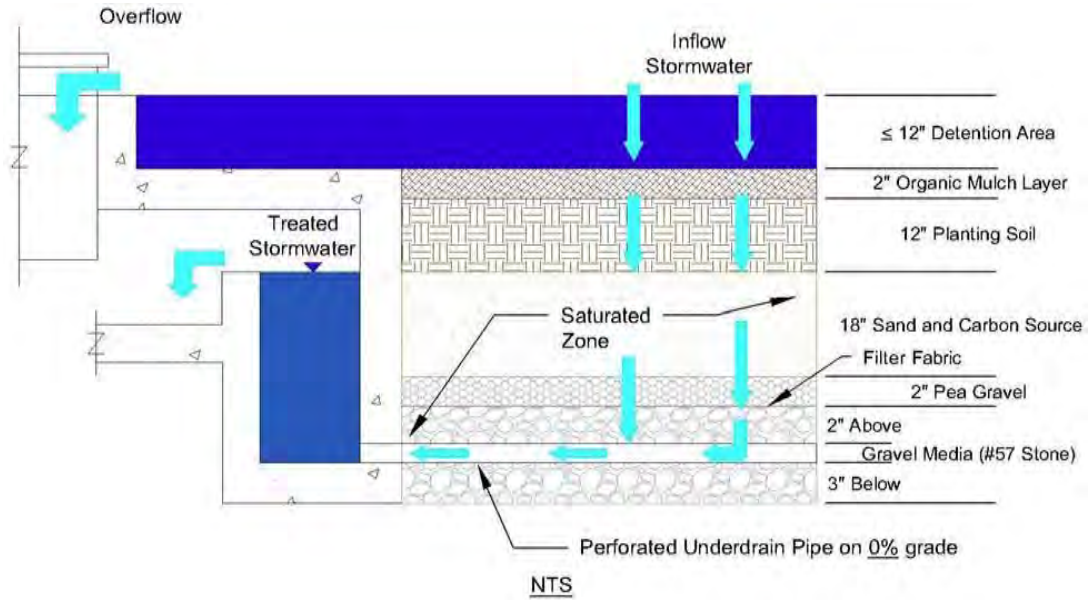

Figure 4.12.3. Cross Section View of System with Overflow.

Stormwater Planter CD

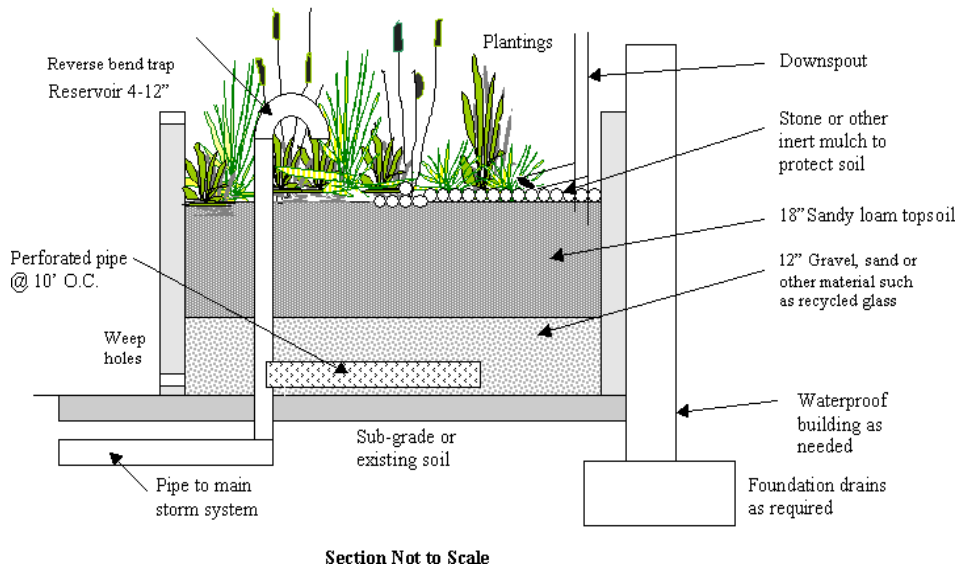

Figure 4.12.4. Example Stormwater Planter Box Biofiltration System.

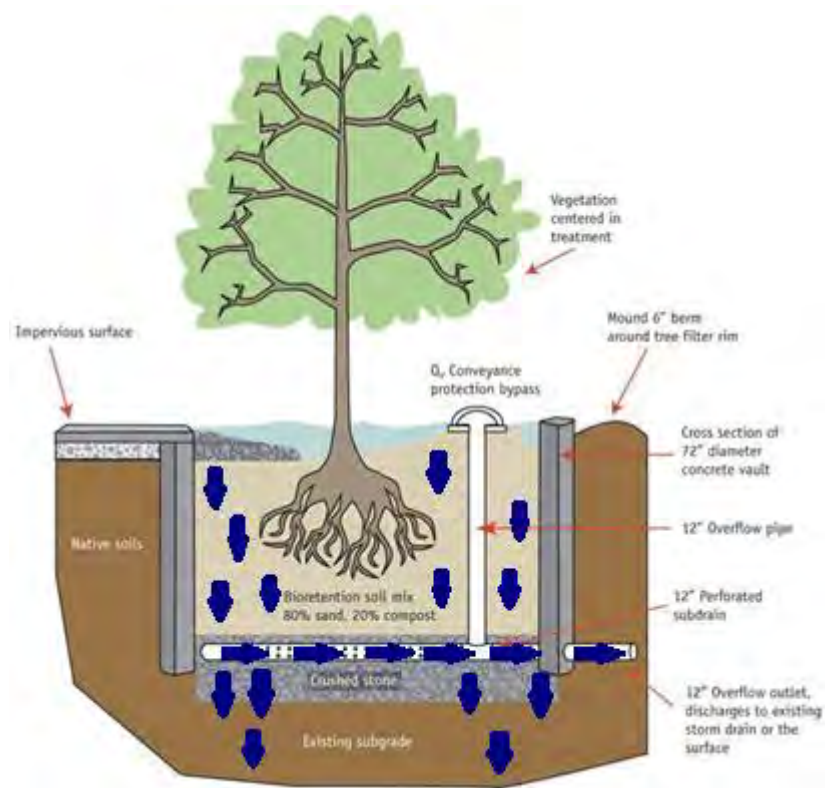

Figure 4.12 5. Example Stormwater Tree Box Filter System.

3. General feasibility

Biofiltration systems are suitable for many types of development, from single-family residential to high-density commercial projects. Because the shape and sizing of systems are relatively flexible, the systems can be incorporated into many landscaped designs. These systems can be used near impervious areas such as within roadway medians, parking lot islands, or planter boxes. Biofiltration systems are also well suited for treating runoff from pervious areas, such as recreational fields, golf courses, or landscaped areas. Biofiltration systems may also be used to treat roof runoff, in which case they could be installed with all or a part of the system above ground. If biofiltration systems are installed above ground, the same fundamental design requirements would have to be met as with in-ground biofiltration systems and the biofiltration system would have to discharge through an under-drain system. Biofiltration systems are not suitable for regional stormwater control.

4. Physical constraints

When evaluating the appropriateness of a biofiltration system, a designer should consider some of the physical constraints associated with this type of treatment system, including:

- A. **Contributing watershed area** – less than two-acres and preferably less than one-acre.
- B. **Seasonal high-water table** – separated by structural means from hydraulic contribution of the surrounding water table.
- C. **Soils** – stormwater must pass through at least two inches of topsoil, an appropriate depth of planting soil, and a minimum of 12 inches of filter media with a carbon source (BAM) before entering the perforated underdrain discharge pipe.

- D. **Discharge** - the biofiltration system must be able to discharge into an appropriate conveyance system such as a storm sewer with adequate capacity.

4.12.4. Design Considerations and Requirements

The following criteria are to be considered minimum standards for the design of biofiltration systems in Pinellas County. Consult with SWFWMD to determine whether any variations must be made to these criteria or if additional standards must be followed.

1. Location and Planning

Biofiltration systems are designed for intermittent flow and should not be used on sites with a continuous flow from ground water, sump pumps, or other sources. Locations of biofiltration systems should be integrated into the site-planning process, and aesthetic considerations should be taken into account in their siting and design. All control elevations must be specified to ensure that runoff entering the facility does not exceed the design depth. Biofiltration systems can be installed partly or fully above ground as a planter box to treat roof runoff. However, these systems must still be lined and drained by an underdrain that discharges into an appropriate conveyance system such as a storm sewer with adequate capacity.

2. General Criteria

A detention system with biofiltration must consist of the following:

- A. *Prefilter strip* – Where feasible, a vegetative buffer between the contributing watershed area and the ponding area or swale conveyances must be used to capture coarse sediments and reduce sediment loading to the detention area. The applicant may propose other measures to minimize the sediments entering the biofilter. Biofiltration systems that do not include a prefilter strip or other pretreatment measures must include a detailed operation and maintenance plan.
- B. *Ponding area* – An area that provides temporary surface storage (less than 12 inches) for runoff before flowing into and through the soil treatment bed.
- C. *Organic mulch layer* – if used, a two to three-inch layer (non-floating mulch) that attenuates heavy metals, reduces weed establishment, regulates soil temperature and moisture, and adds organic matter to the soil.
- D. *Engineered soil filter bed* – a layer that provides at least 12 inches of planting media for vegetation within the basin as well as a sorption site for pollutants and a matrix for soil microbes.
- E. *BAM bed with carbon source* – a layer at least 12 inches thick at the bottom of the biofiltration system that facilitates denitrification under anoxic conditions. This layer also removes additional pollutants. If phosphorus removal is the goal, a carbon source is not necessary.
- F. *Woody and herbaceous plants* – [Florida-Friendly Landscaping™](#) plants that provide a carbon source for the biofiltration system, help facilitate microbial activity, and improve infiltration rates. Roots must be kept away from the underdrain.
- G. *Underdrain* - a system facilitating the positive drainage of stormwater through the soil/filtration media and into the discharge conveyance system, refer to [County Standard Detail index 1290](#)
- H. *Control structure* - a structure that creates an anoxic zone up to the elevation of the top of the sand layer.
- I. *Energy-dissipation mechanism* – a structure that reduces runoff velocities, distributes flow, and reduces disturbance of the mulch layer.
- J. *Overflow pipe or spillway* – a structure to allow rainfall events that exceed cell volume capacity to

bypass the system. The discharge invert should be set no higher than 12 inches above the soil surface with the applicable downstream erosion-control measures.

3. Sizing Requirements

A. Prefilter strip

- The prefilter strip design will depend on topography, flow velocities, volume entering the buffer, and site constraints.
- The prefilter strip is typically a vegetated buffer or swale.
- Inflow to the prefilter should be dispersed with low non-erosive velocities.

B. Ponding area

- The maximum ponding depth must be no more than 12 inches below the overflow structure.
- The recovery time must be less than 36 hours to ensure plant survival.

C. Organic mulch layer (IF USED)

- The surface organic mulch layer must be at least two inches deep and cover the surface of the basin to at least six inches above the expected high-water line. The selected mulch must be non-floating.
- Mulch depth must never exceed 4 inches or soil aeration may be reduced.
- Hardwood mulch must be used due to its higher pH, improved microbial activity, and slower decomposition rate. Examples of acceptable mulches are those made from Melaleuca or Eucalyptus trees. Pine bark or pine straw is not acceptable. The hardwood mulch selected must also be [Florida-Friendly™](#). Cypress mulch is often not harvested sustainably, is not considered a [Florida-Friendly™ mulch](#) and is not acceptable.
- Partially composted mulch is acceptable, especially in the lower parts of the depression as this will reduce the tendency of the mulch to float.

D. Planting soil filter bed

- The planting soil filter bed must be at least six inches thick.
- The bed material must be sandy loam, loamy sand, or loam texture.
- Clay content must be between three and five percent.
- Soil pH must be between appropriate for plant growth.
- Top soil organic matter content must be sufficient to support good plant growth.
- The soil mix must be uniform and free of stones, stumps, roots, or other similar material greater than two inches in size.
- The suggested hydraulic conductivity for the planting soil is 4 to 12 inches per hour. Design hydraulic conductivities that fall outside this range must be agreed to in writing during the pre-application meeting.

E. Biosorption Activated Media (BAM)

- The sand bed with a carbon source must be at least 12 inches thick at a minimum
- The unit weight must be more than 70 pounds per cubic foot when dry.
- No more than 5 percent of the particles pass through a #200 sieve.

- The media composition must adhere to the requirements outlined in the BAM specification in appendix I of this manual.
- The media water holding capacity must be at least 30% as measured by porosity.
- The vertical permeability must be at least two inches per hour at the specified unit weight noted above.
- The media must have an organic content at least five percent by volume. The organic content must be in the form of one inch hardwood chips (e.g. Melaleuca or Eucalyptus woodchips) evenly distributed throughout the layer.
- The media pH must be between 6.5 and 8.0 or suitable for the selected plant species.
- The concentration of soluble salts must be less than 3.5 g (KCl)/L.
- The sorption capacity of the sand must exceed 0.005 mg OP/mg media.

F. Under-drain system

1. Pipe

- Underdrain pipe must be at least six inches in diameter PVC or HDPE pipe.
- Perforations must meet the AASHTO M 36 or M 196 requirements.
- Pipe must be spaced no more than ten feet apart on center.
- Pipes will have a positive drainage even under high tailwater conditions.

2. Gravel media

- Pipe must be laid on three inches of double-washed no. 57 aggregate and then filled around both sides of the pipe and over the top at least three inches. If pea gravel is used, a minimum of six inches of fill is required.
- Gravel must extend to the full width and length of the Sand and Carbon Source Layer to allow for an even flow through this layer
- The course gravel layer must be overlaid with non-woven, non- degradable filter fabric that meets the geotextile requirements provided in FDOT Design Standards Index No. 199 for Geotextile Type D-3.
- Filter fabric must be covered with 2 inches of ¼-inch to ½-inch double-washed pea gravel to reduce the likelihood of clogging.

3. Control structure

- A control structure that creates an anoxic zone to the top of the sand layer must be placed downstream of the underdrain system.
- The control structure must be designed to preclude a siphon from forming.
- The control structure must be designed so that it does not inhibit maintenance and cleanout of the underdrain system.

4. Discharge Requirements

The biofiltration system is primarily a water quality treatment system and does not need to meet any specific discharge requirements. However, an overflow structure and non-erosive overflow channel must be provided to safely pass flows that exceed the storage capacity of the biofiltration system to a stabilized downstream area or conveyance system. The complete stormwater treatment system for the

site must meet County water quantity discharge requirements.

5. Recovery Requirements

The appropriate Florida-registered professional must demonstrate through an underdrain recovery calculation or by underdrain recovery modeling that under high tailwater conditions there is no standing water in the biofiltration system 36 hours after the stormwater treatment volume is applied. The assumed hydraulic conductivity for the planting soil must be stated clearly as this will be used when testing biofiltration systems.

6. Stormwater Quantity Credits

Biofiltration systems typically are used for stormwater treatment and not for flow attenuation. However, the effectiveness of a biofiltration system at attenuating peak flows can be calculated using one of the following procedures:

- Calculating the curve number (CN) for the biofiltration area and including this in the area weighted CN for the entire site.
- Explicitly modeling the hydraulic functioning of the biofiltration system— including the underdrain and overflow control structures.

7. Stormwater Pollutant Load Requirements/Credits

No specific treatment requirement is associated with a single biofiltration system. These systems are intended to be part of a BMP treatment train, where each practice in the train provides incremental water quality benefits. The level of treatment that can be expected from these systems is based on the average annual volume of water captured and filtered by the biofiltration system and the pollutant load removal efficiency of biofiltration system.

The annual average pollutant-load reduction for metals, nitrogen, and phosphorus must be calculated for a biofiltration system to be considered part of the water quality treatment. Removal efficiencies for all three constituents must be developed using one of the following methods:

- A. Assumed efficiencies – A 45% nitrogen load reduction and 60% phosphorus load reduction is presumed for biofiltration systems that are designed to the minimum recommended design criteria in this Manual. Systems that are designed with substantial deviations from the design criteria will require the removal efficiency to be determined for the specific design in discussions with the County staff at the pre-application meetings. Additionally, the system effectiveness will need to be confirmed using water quality monitoring for a duration and frequency agreed to by the County Staff at the pre-application meetings. If the assumed removal efficiencies are found to exceed the measured removal efficiencies, the County may request that the property owner perform on-site mitigation to achieve the permitted removal efficiencies.
- B. Literature values – these must be agreed to in writing by County staff at the pre-application meeting.

The percentage of the average annual runoff volume that is filtered by the biofiltration system may be estimated by using one of the following methods:

- A. Continuous simulation - a continuous simulation of the biofiltration system using an applicable long-term rainfall record (at least 20 years).
- B. Design Curve – Figure 4.12.6. may be used to determine the percentage of the average annual volume of water filtered or captured by the biofiltration system. This figure requires that the equivalent impervious area (EIA) and detention volume are known. The EIA is equal to the mean annual runoff coefficient multiplied by the contributing watershed area. Be sure to treat directly

connected impervious area as 100% DCIA rather than having a CN of 98.

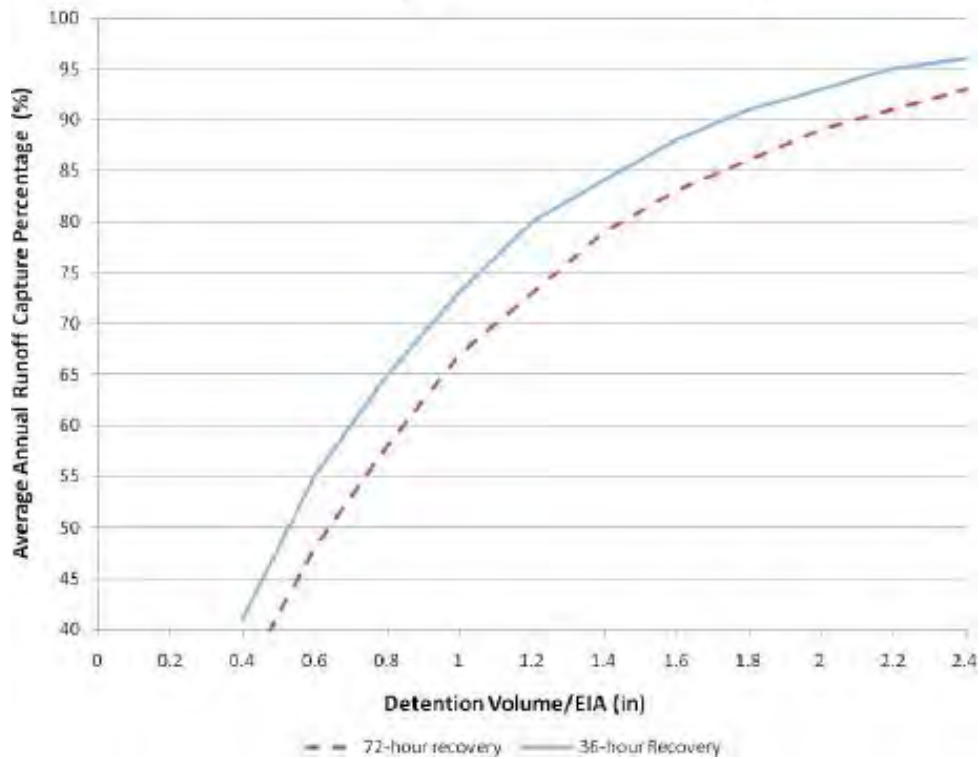

Figure 4.12.6. Average Annual Runoff Capture Efficiency for a Biofiltration System in Pinellas County.

The average annual pollutant load reduction can then be calculated by multiplying the removal efficiency by the percentage of the average annual runoff that is captured and filtered by the biofiltration system. For example, a system that captures and filters 70% of the average annual runoff volume and has a removal efficiency of 40% for nitrogen will result in a 28% average annual nitrogen load reduction.

8. Maintenance Access

Access to the biofiltration system must be provided at all times for inspection, maintenance, and landscaping upkeep. There must be sufficient space around the biofiltration system to allow accumulated surface sediments to be removed and possibly for underdrains to be cleaned out or replaced if they should fail infiltration tests or inspection. To facilitate maintenance of the underdrain system, capped and sealed inspection and cleanout ports that extend to the surface of the ground must be provided at the following locations for each stormwater pipe at a minimum:

- A. The beginning and end of each run of pipe.
- B. At every 50 feet or every bend of greater than 45 or more degrees, whichever is shorter.

9. Safety Features

Due to their shallow ponding depth, biofiltration systems generally do not require any special safety features such as fencing. Railings or a grate can be used to address safety concerns if the area is designed with vertical walls.

10. Landscaping

Landscaping enhances the performance and function of biofiltration systems. Selecting plant material based on hydrologic conditions in the basin and aesthetics will improve plant survival, public acceptance, and overall treatment efficiency. [Native](#) or [Florida-Friendly™](#) plants will be selected. A [filterable list of some suggested plants for biofiltration systems](#) is available on the County website. All landscaping recommendations should be considered before storm flows are conveyed to the biofiltration system:

Landscaping of Catchment

- A. The unpaved contributing area should be well vegetated to minimize erosion and sediment inputs to the biofiltration system.
- B. Where feasible, a prefilter vegetative strip or vegetative swale should be installed.
- C. If used, trees should be spaced 12 to 15 feet apart depending on the type.
- D. Plants should be placed at irregular intervals.
- E. If woody vegetation is used, it should be placed along the banks and edges of the biofiltration system, not in the direct flow path.
- F. Only species well adapted to the regional climate should be used.
- G. Species planted in well-drained media should tolerate short-term ponding as well as periods of low soil moisture.
- H. Plants in the vicinity of the underdrains will not have extensive root systems that can damage the underdrains.

4.12.5. Biofiltration Design Procedure

The following procedures are intended to guide an applicant through the design of a detention system with biofiltration:

1. Design Steps

- Step 1 – Determine if the development site and conditions are appropriate for the use of a biofiltration system. Consider the Application and Site Feasibility Criteria discussed earlier.
- Step 2 – Determine the watershed/drainage area and the equivalent impervious area (EIA) for the watershed/drainage area. [EIA = C x Drainage Area].
- Step 3 – Compute the maximum detention volume that will be detained in the surface storage of the biofiltration system (maximum depth 12 inches).
- Step 4 – Set design elevations and dimensions of facility.
- Step 5 – Design a pretreatment system if practicable — either a vegetative buffer, prefilter strip or vegetative swale.
- Step 6 – Size the underdrain system and downstream control structure.
- Step 7 – Design the emergency overflow. An overflow must be provided to bypass and/or convey larger flows to the downstream stormwater system or stabilized watercourse. Non-erosive velocities need to be ensured at the outlet point.
- Step 8 – Determine the Average Annual Pollutant-Load Reduction. This annual average pollutant-load reduction for TN and TP must be calculated.
- Step 9 – Calculate the peak attenuation credit.

- Step 10 – Prepare the vegetation and landscaping plan. A landscaping plan for the detention area should be prepared to indicate how the area would be established with vegetation.

4.12.6. Biofiltration Design Example

Assume that a stormwater BMP is needed to help meet the water quality objectives of a site. The portion of a site analyzed in the example includes one-acre of paving plus an area that is 80 feet by 30 feet to be used for a biofiltration system. The following are sample calculations for determining the pollutant load removal efficiency of a biofiltration system.

- Step 1 – Assume that the applicant has determined that the site meets the criteria specified in 4.12.2 and 4.12.3. Therefore, a biofiltration system is an appropriate choice for a BMP on this site.
- Step 2 – The contributing area is a one-acre paved surface plus a 0.06 acre biofiltration system. The mean annual runoff coefficient for the paved surface and the biofiltration surface is 0.823. Therefore, the EIA for the paving and the biofiltration system is 0.872 acre = $[1 * 0.823 + 0.06 * 0.823]$.
- Step 3 – The area available for the biofiltration system is limited to approximately 80 feet by 30 feet (Area at top of storage = $80 * 30 = 2400$ sf). Therefore, using the maximum detention depth of one foot, and assuming a side slope of 3:1 (area and bottom of storage = $74 * 24 = 1776$ sf) the maximum detention volume detained on the surface of the biofiltration area is calculated to be 2,088 = $[(2400 \text{ sf} + 1776 \text{ sf})/2] * 1 \text{ foot}$] cubic feet.
- Step 4 – The design elevations are then set.
- Step 5 – Assume that the applicant has found that there is sufficient space for a prefilter strip. If the biofiltration system also incorporates infiltration, having a prefilter reduces the frequency of infiltration rate testing to once every 3 years, rather than once every 18 months, which is required if no prefilter strip is included. (See Table 1.8.1)
- Step 6 – The applicant then sizes the underdrain to recover in 36 hours and to create the anoxic zone that is 24 inches deep.
- Step 7 – Ensure that flood control is provided to meet Pinellas County requirements.
- Step 8 – The average annual pollutant removal efficiency would be calculated. Dividing the detention volume by the EIA gives a detention volume of 0.66 ($2088 \text{ cf} / .872 \text{ acre} * 12 / 43560$) inch over the EIA. Figure 4.12.6. shows that approximately 58% of the average annual runoff would be filtered by the biofiltration system. Given that the system provides a 40% removal of nitrogen, it can be calculated that the system would achieve a 23% reduction in nitrogen loading from the paved area.

4.12.7. Operation and Maintenance

1. **Routine Inspections** - The operation and maintenance entity must conduct regular inspections of the biofiltration system immediately after a rainfall to ensure it is operating as permitted. At a minimum, an inspection should occur in the spring, before the rainy season begins in June, and during the rainy season. At a minimum the following should be inspected:

(1)	Inspect inflow/outflow points for any clogging.
(2)	Inspect prefilter strip vegetated buffer/grass swale and ponding area for erosion or gullyng.
(3)	Inspect trees and shrubs to evaluate their health.

(4)	Inspect the underdrain system to ensure it is not clogged.
-----	--

2. **Maintenance** - Any problems identified during the routine inspection must be corrected as soon as possible. To ensure the system is properly maintained and to continue to receive stormwater treatment credits, the operation and maintenance entity must:

(1)	Prune and weed to keep any structures clear.
(2)	Maintain/mow the vegetated buffer, prefilter strip or swale at least twice during the growing season and remove clippings from the flow path.
(3)	If used, replace mulch where needed when erosion is evident.
(4)	Remove trash and debris as needed.
(5)	If used, replace mulch over the entire area every 2 to 3 years.
(6)	Remove sediment from inflow system and outflow system, including underdrains, as needed. Flush underdrains as needed to maintain their flow capacity.
(7)	Stabilize any upstream erosion as needed.
(8)	Remove and replace any dead or severely damaged vegetation.

3. **Recertification Inspection and Testing** - The operation and maintenance entity is required to provide for the inspection of the entire stormwater management system by a Florida registered professional engineer to assure that the system is properly operated and maintained. The inspections will be performed 18 months after operation is authorized by both the County and every 18 months thereafter. The report is due to the County within 30 days of the date of inspection.

A Florida-registered professional engineer must provide reasonable assurance that the biofiltration system is functioning as intended. Results as well as remedial actions must be reported to the County. For sites that include a large number of biofiltration systems, a testing schedule in which a representative sample of biofiltration systems are tested at the appropriate interval may be agreed to at the pre-application meeting or during the permitting process. Testing must include the following:

- The planting soils pH must be tested at least once every three years. Planting soils pH must be appropriate for the plants used in the system.
- Biofiltration systems that include infiltration components require that a double-ring infiltration test be performed every three years at up to three locations in the bottom of the basin to confirm design infiltration rates. If two out of three tests are below the design criteria or the average rate of the three tests is below the design criteria, the mulch layer and surficial soil layer must be restored. Core aeration or cultivating of non-vegetated areas may be sufficient to ensure adequate filtration.

4.12.8. Planter Box Biofiltration Systems

All of the above requirements for biofiltration systems apply to Planter Box biofilters unless they are superseded by specific requirements below.

- Description** - Planter box biofilters are structural landscaped reservoirs used to collect and filter stormwater, allowing pollutants to settle and filter out as the water percolates through the vegetation, growing medium, and gravel. Excess stormwater collects in a perforated pipe at the bottom of the flow through planter and drains to an approved discharge point and conveyance. Planters can be used to help fulfill a site's required landscaping area requirement and should be integrated into the overall site design. Numerous design variations of shape, wall treatment, and planting scheme can be used to fit the character of a site. Because flow-through planters can be constructed immediately next to buildings, they are ideal for sites with setback requirements, poorly draining soils, or other constraints.
- Setbacks** - Biofiltration planters that rely on infiltration are typically set back five feet from property lines and ten feet from building foundations. No setbacks are required for lined flow-through planters where the height above finished grade is 30 inches or less. Lined flow-through planters can be used next to foundation walls, adjacent to property lines, or on slopes when they include a waterproof lining.
- Contributing watershed (drainage) area** - The maximum contributing watershed area is 2,500 sq. ft. However, this is considered a general rule. Larger watershed areas may be allowed by Pinellas County if the biofiltration system has sufficient flow controls and other mechanisms to ensure proper function, safety, and community acceptance. The watershed areas in these urban settings are typically considered to be 100% impervious.
- Planter biofiltration system sizing and pollutant load reduction** - Planter biofiltration systems that use infiltration and are not underdrained can be sized similar to retention basins by using Table 6.10.5. to determine the desired treatment volume. The treatment volume will then determine the annual load reduction percentage. If the biofiltration system requires an underdrain and discharge off-site, the area of the biofiltration system will be determined by the desired treatment volume and the biofiltration media characteristics. These, in turn, will determine the pollutant load reduction.
- Dimensions and slopes** - The minimum infiltration planter width is 30 inches, and the minimum flow-through planter width is 18 inches (measured from inside the planter walls). Storage depth must be between 6 and 12 inches (from inlet elevation of overflow to top of growing medium). Planters are flat facilities that do not slope more than 0.5 percent in any direction. A minimum of two inches of freeboard (vertical distance between the design water surface elevation and overtopping elevation) will be provided.
- Planter walls** - Planter walls will be made of stone, concrete, brick, or other durable material. For planters that require an impervious bottom, a single-pour concrete solution is preferred. Chemically treated wood that can leach out toxic chemicals and contaminate stormwater will not be used.

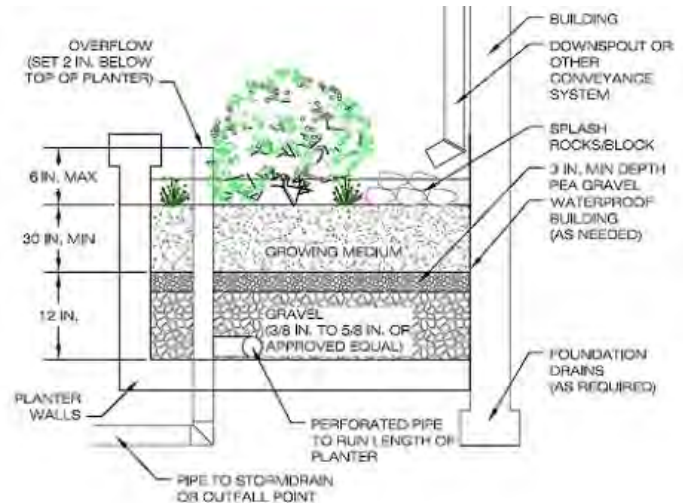

5. **Liners** - Flow-through facilities that require an impervious bottom can be achieved through either a waterproof liner (geomembrane) or a single-pour concrete box. If lined, there are many liner options, and installation varies. Liners should be installed to the high water mark. Liner will be 30 to 40- mil PVC or HDPE as appropriate or approved equivalent.
6. **Vegetation** - The entire planter box filter must be planted with vegetation. The facility area is equivalent to the total area of the planter, as developed in the sizing calculations. The entire surface area of a planter is inundated with water and therefore requires plants that will survive such conditions. Minimum quantities are shown below:

Minimum Vegetation Quantities				
NUMBER OF PLANTS	TYPE OF PLANTS	PER SQUARE FEET	SIZE	SPACING ON CENTER
115	Herbaceous	100	1 gallon	1'
OR				
100	Herbaceous	100	1 gallon	1'
4	Small shrubs	100	1 gallon	2'

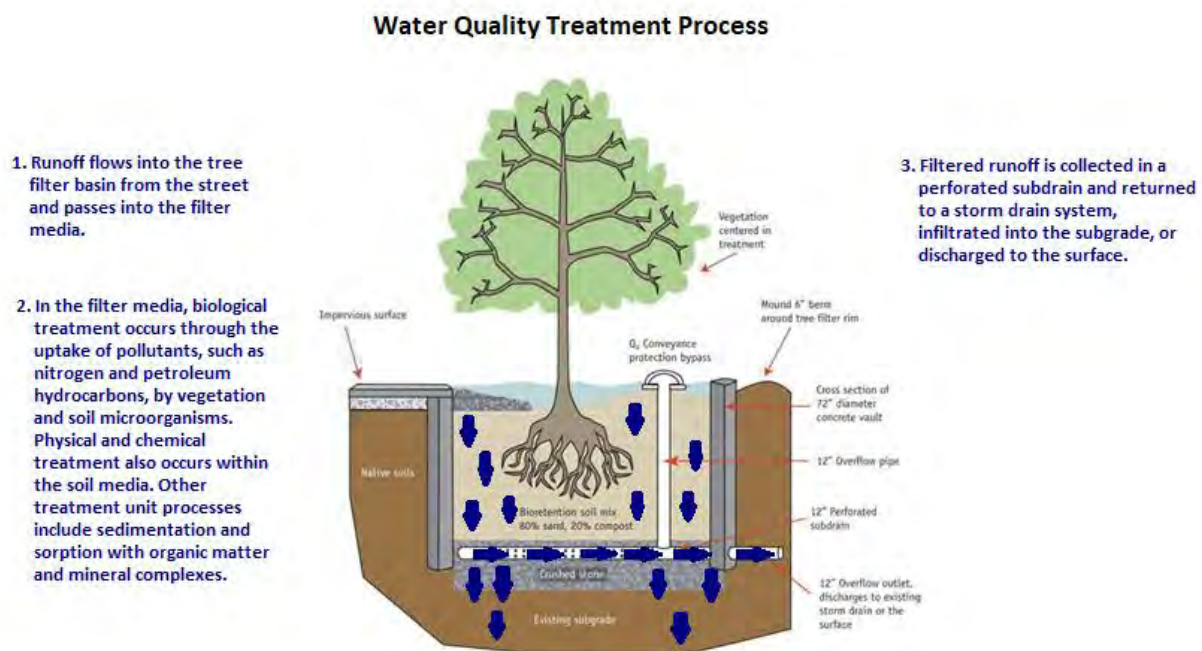

Note: Tree planting is not required in planters but is encouraged where practical. Tree planting is also encouraged near planters.

7. **Construction Considerations** - Special attention should be paid to the structural waterproofing if the planter is constructed adjacent to building structures.

4.12.9. Tree Box Filter Systems

1. **Description** - Tree box filters typically are pre-cast concrete boxes filled with biofiltration media installed below grade at the curb line. A standard street tree or shrub is planted in the box, which resembles a curbside planter. Tree box filters are located upstream of a standard curb inlet. For low to moderate flows, stormwater enters through the tree box's inlet, filters through the soil, and exits through an underdrain into the storm drain. When the tree box filter is full, excess street flows will bypass the tree box filter and flow directly to the downstream curb inlet. They serve as attractive landscaping and stormwater catch basins. Unlike many other forms of urban landscaping, they are not isolated behind curbs and deprived of water and nutrients in runoff. Their water quality treatment performance is moderate, depending on the size and composition of the filter media. In those cases where the soils are appropriate for infiltration, the tree box filter should be designed following the recommendations for Interceptor Trees.



2. **Applicability** - Tree box filters can be used throughout Florida and are especially useful in highly urbanized settings where available space is at a premium. They can be installed in open- or closed-bottomed chambers where infiltration is undesirable or not possible, such as clay soils, sites with high groundwater, and areas with highly contaminated runoff.

Tree box filters are often installed along urban sidewalks, but they are highly adaptable and can be used in most development scenarios. In urban areas, tree filters can be used in the design of an integrated street landscape—a choice that transforms isolated street trees into stormwater filtration devices. They also can be used in designs that seek to convert entire non-functional streetscapes into large stormwater filtration systems.

3. **Water quantity benefits** - Individual tree box filters hold a relatively small volume of stormwater (100-300 gallons), but concerted use throughout a contributing watershed area will decrease the total volume and peak flow rate of discharged stormwater. Tree box filters are designed to capture the water quality volume of stormwater.

They are not intended to capture larger volumes or to detain the water quality volume for extended periods of time, however.

4. **Water quality benefits** - Tree box filters remove pollutants through the same physical, chemical, and biological mechanisms as other biofiltration systems, and have moderate removal rates for pollutants in stormwater. They also provide the added value of aesthetics while making efficient use of available land for stormwater management.

5 Design Criteria

- a. **In general**, tree box filters are sized and spaced much like catch basins, and design variations for these systems are abundant. The tree box filter's basic design is a concrete vault filled with a biofiltration media, planted with vegetation, with an underdrain. The bottom is usually closed unless the soils are appropriate for infiltration. Vegetation selected for these systems should consist of [Florida-Friendly™](#) species on the County's approved plant list in [Section 138-3664](#). Plants with aggressive root growth may clog the underdrain, and therefore may not be suitable for this type of system. The tree box filter can be sized for a specific stormwater treatment volume and should

allow for four to six inches of ponding. Larger storm events will be bypassed.

- b. **Soil volume requirements** – When planting trees, the volume of soil provided must be considered carefully. It must be adequate for root development or the tree will not grow to a full size, and its health may be impacted. At maturity, tree roots often extend more than twice as far as the tree's canopy. In urban settings, that ideal volume is usually not available, but the reduction in volume of soil will directly impact the potential size of the tree. A tree box containing 120 ft³ (in a typical 4' x 10' x 3' tree box) might allow a tree to spread to about 10 ft. diameter canopy before it declines. The same tree in a box containing 500 ft³ could be expected to grow to a diameter of more than 20 ft. Void spaces in the soil are also necessary for the tree to obtain both water and air, so it is important that the surrounding soil is not compacted. A good design reference for tree boxes is:
 - <http://caseytrees.org/resources/publications/treespacedesign/>
- c. **Tree Size and Species.** Trees will comply with [Section 138-3655 – Minimum Plant Material Specifications](#) and the County's approved plant list found in [Section 138-3664 of Article X Community Design Standards](#).
- d. **Tree box components** - Tree box filters consist of a pre-cast concrete container, a mulch (non-floating) layer, biofiltration media mix, observation and cleanout pipes, underdrain pipes, one street tree or large shrub, and a grate landscape cover.
- e. **Contributing watershed area** - Tree boxes typically treat runoff from a watershed area of a 0.25 acre or less, although watershed area size is a function of tree box filter size.
- f. **Location and spacing** - Tree boxes must be regularly spaced along the length of a corridor as appropriate to meet the desired annual treatment target. A standard curb inlet must be located downstream of the tree box filter to intercept bypass flow. Tree box filters are off-line devices and should never be placed in a sump position (i.e. low point). Instead, runoff should flow across the inlet (e.g. left to right). Also, tree box filters are intended for intermittent flows and must not be used as larger event detention devices.
- g. **Inspection and maintenance** - Tree box filters should be inspected annually in the Spring before the rainy season begins. To ensure proper performance, visually inspect that stormwater is infiltrating properly into the tree box filter. Excessive volumes of stormwater bypassing the tree box filter to the standard inlet may indicate operational problems. Corrective measures to restore performance include inspection for accumulated sediments and debris and removal, if necessary. In instances where the condition of the soil media has degraded significantly, the media and vegetation should be removed.

Routine maintenance consists of regular removal of trash and debris and vegetation maintenance. The mulch will need to be replenished one to two times per year. The cleanout pipe can be used to flush the system if the underdrain becomes clogged. During extreme droughts, the trees or shrubs may need to be watered in the same manner as any other landscaping. The plants may need to be replaced every few years.

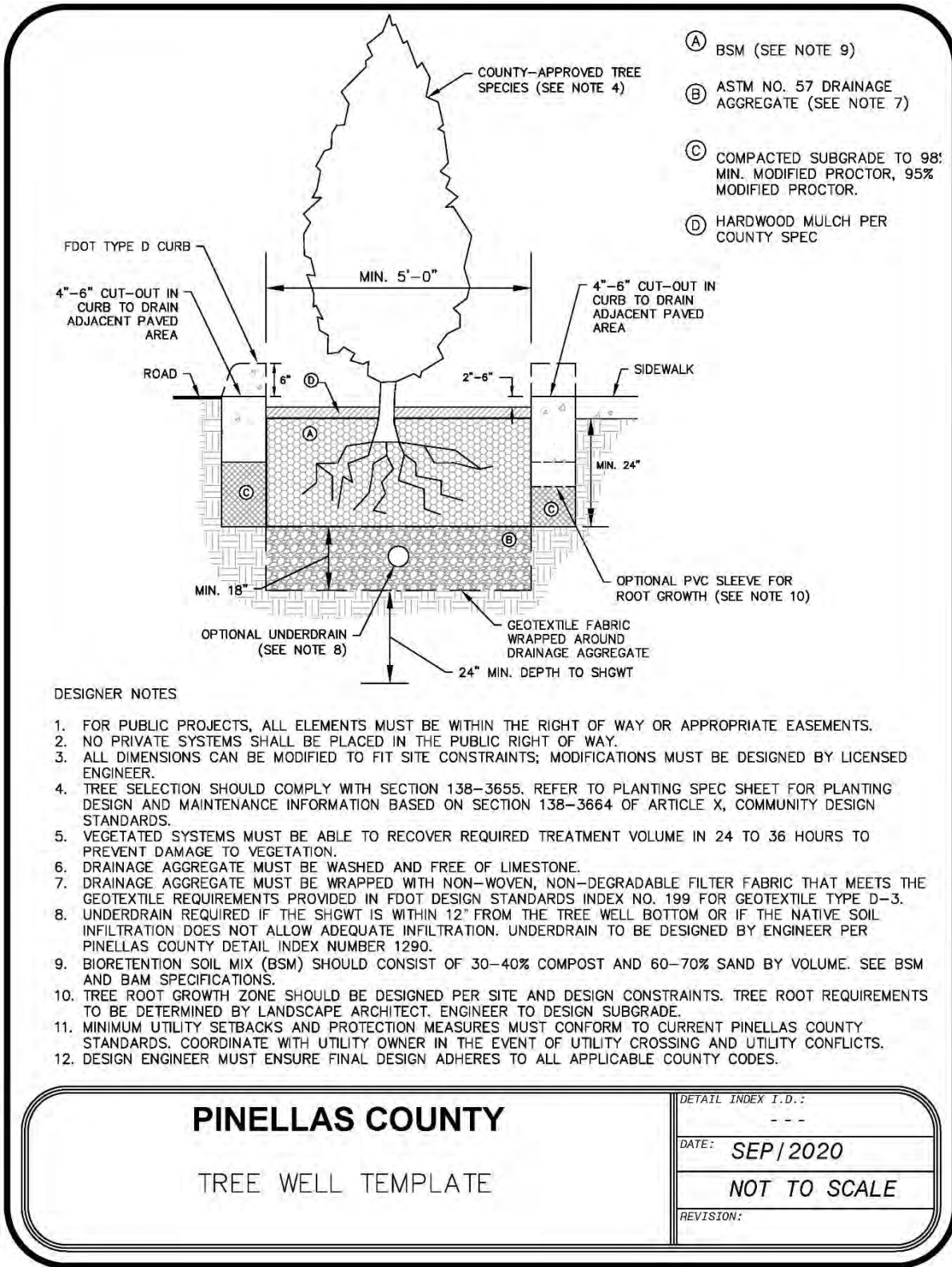

Figure 4.12.7: Pinellas County CAD template for tree wells

4.13. Rain Gardens

4.13.1. Description

Rain gardens are small retention basins that can be integrated into a site's landscaping. A rain garden is a shallow, constructed depression that is planted with deep-rooted [Florida-Friendly Landscaping™ plants](#). It is located in the landscape to receive runoff from hard surfaces such as a roof, a sidewalk, a driveway, or parking area. Rain gardens slow down the rush of water from these impervious surfaces, holds the water for a short period of time and allows it to naturally infiltrate into the ground.

Rain gardens have multiple functions. They recharge the local aquifer by increasing the amount of water that filters into the ground; reduce the amount of stormwater pollutants – fertilizer, pesticides, car oil, etc. – that enter nearby surface water bodies; provide habitat for birds, butterflies, and beneficial insects; and improve property value by adding curb appeal to the landscape. Rain gardens are a beautiful and colorful way for homeowners, businesses and municipalities to help ease stormwater pollution problems. A rain garden also conserves municipal water resources by reducing the need for potable water irrigation.



RAIN GARDEN SUMMARY

Advantages/Benefits	Reduces stormwater volume and pollutant loadings; provides ground water recharge and enhanced site aesthetics; integrate into site's landscaping.
Disadvantages/Limitations	Small contributing watershed/drainage area. Do not construct within 50 feet of a public or private potable water supply well or within 15 feet of an onsite wastewater disposal and treatment system. Site must have appropriate soil and SHGWT conditions for infiltration.
Volume Reduction Potential	Medium
Pollutant Removal Potential	High for all pollutants
Key design considerations	SHGWT at least two feet below bottom; recovery of treatment volume within 24 – 72 hours; plant with Florida-Friendly™ plants appropriate for dry and wet conditions.
Key construction and maintenance considerations	Minimize soil compaction and sedimentation during construction; ensure design infiltration is met after construction; inspect during wet season to see if water is ponding and not infiltrating properly; restore non-floating mulch, remove weeds, and replant as necessary.

4.13.2. Treatment Effectiveness



Rain gardens will be used as part of a BMP Treatment Train to achieve the required nutrient load reduction set forth in the performance standards in **Section 3.1.1.** of this Manual. The treatment effectiveness of a rain garden will be based on the stormwater treatment volume that is retained on-site. Use Table 6.10.5. to determine the load reduction associated with the selected stormwater treatment volume for the particular DCIA and non-DCIA characteristics of the site.

4.13.3. Design Criteria

Follow the design criteria for Retention Basins in Section 4.1.4. and the following specific design criteria for rain gardens.

1. **Maximum contributing watershed/drainage area** - Rain gardens will be used only when the contributing watershed area is less than two acres.
2. **Ponding depth** - Rain gardens will have a minimum ponding depth of four inches and a maximum depth of ten inches.
3. **Location** - Rain garden will be at least ten feet away from a structure to prevent seepage or flooding. Do not locate the garden over a septic field. Try to choose a naturally occurring low spot in the landscape or position the rain garden where gutter downspouts or sump pump outlet can be used to direct rainwater into the rain garden. Try to choose a location in the sun, either full or partial.
4. **Measure watershed area and treatment volume.** - Determine the contributing watershed area and its runoff characteristics, then use Table 6.10.5. to determine the treatment volume and associated load reduction
5. **Create a landscaping design** - Whether a rain garden is large or small the same basic principles apply. By planning the rain garden on paper first, one can create the best appearance possible for your rain garden.
6. **Choose the plants** - [Florida-Friendly Landscaping™ plants](#) are suggested for rain garden installations because they are best adapted for the area. Choose plants (flowers and grasses) that will grow well in both wet and dry areas because the rain garden will temporarily fill with rainwater from time to time. Rain gardens rely on plants that will survive dry spells but then soak up excess stormwater during Florida's rainy months, preventing the water from running across your landscape. Include different types of plants in the rain garden to create a complete and cohesive look that will provide year-round interest. Suggested plants for Pinellas County rain gardens are below; however, other species deemed appropriate may also be used. For more plant options, see the [Pinellas County native plant list](#) (searchable/filterable by attribute) and the [Florida Friendly™ Landscape plant selection guide](#), both of which are shown below.

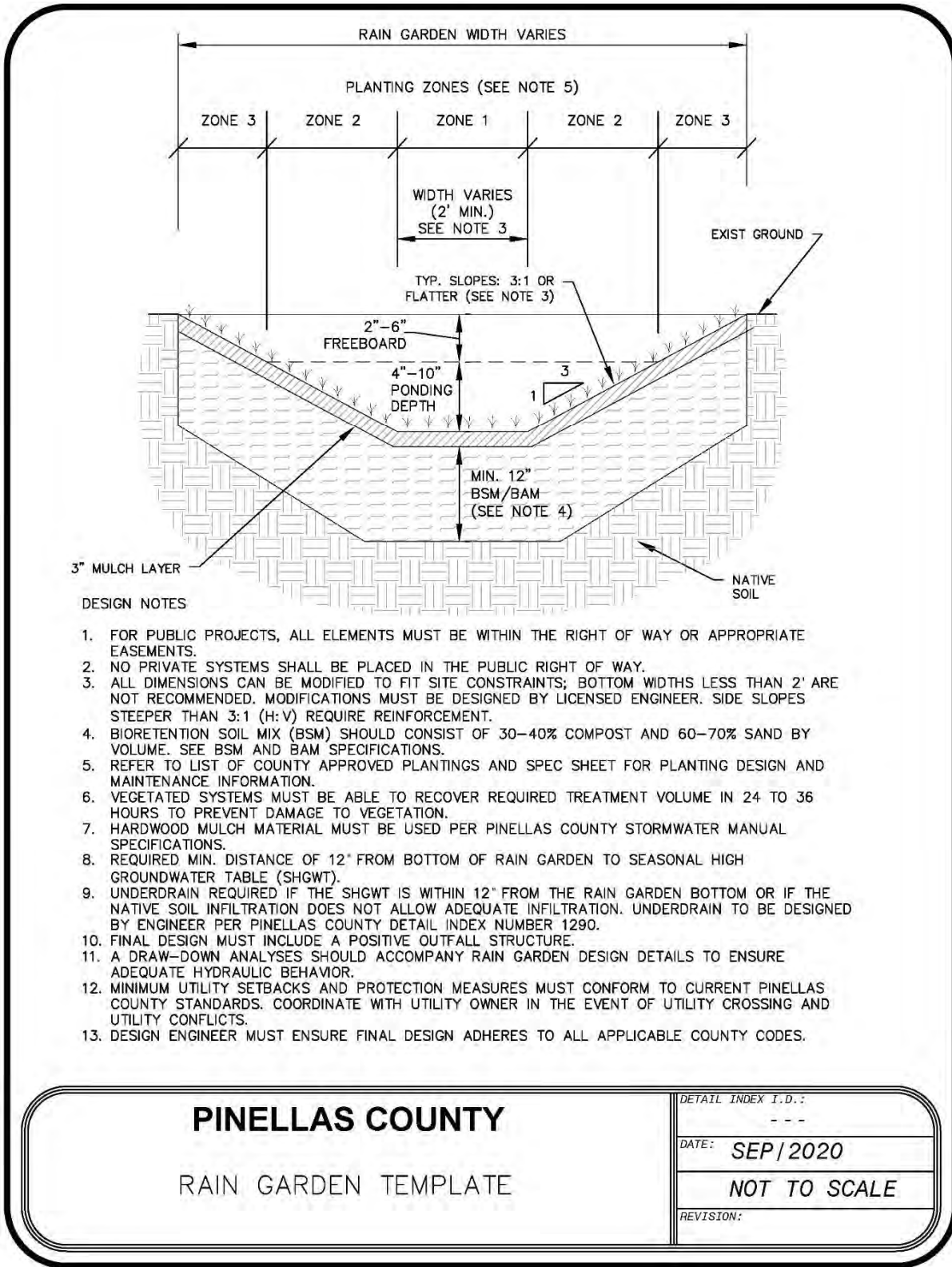

DESIGN NOTES

1. FOR PUBLIC PROJECTS, ALL ELEMENTS MUST BE WITHIN THE RIGHT OF WAY OR APPROPRIATE EASEMENTS.
2. NO PRIVATE SYSTEMS SHALL BE PLACED IN THE PUBLIC RIGHT OF WAY.
3. ALL DIMENSIONS CAN BE MODIFIED TO FIT SITE CONSTRAINTS; BOTTOM WIDTHS LESS THAN 2' ARE NOT RECOMMENDED. MODIFICATIONS MUST BE DESIGNED BY LICENSED ENGINEER. SIDE SLOPES STEEPER THAN 3:1 (H:V) REQUIRE REINFORCEMENT.
4. BIORETENTION SOIL MIX (BSM) SHOULD CONSIST OF 30-40% COMPOST AND 60-70% SAND BY VOLUME. SEE BSM AND BAM SPECIFICATIONS.
5. REFER TO LIST OF COUNTY APPROVED PLANTINGS AND SPEC SHEET FOR PLANTING DESIGN AND MAINTENANCE INFORMATION.
6. VEGETATED SYSTEMS MUST BE ABLE TO RECOVER REQUIRED TREATMENT VOLUME IN 24 TO 36 HOURS TO PREVENT DAMAGE TO VEGETATION.
7. HARDWOOD MULCH MATERIAL MUST BE USED PER PINELLAS COUNTY STORMWATER MANUAL SPECIFICATIONS.
8. REQUIRED MIN. DISTANCE OF 12" FROM BOTTOM OF RAIN GARDEN TO SEASONAL HIGH GROUNDWATER TABLE (SHGW).
9. UNDERDRAIN REQUIRED IF THE SHGW IS WITHIN 12" FROM THE RAIN GARDEN BOTTOM OR IF THE NATIVE SOIL INFILTRATION DOES NOT ALLOW ADEQUATE INFILTRATION. UNDERDRAIN TO BE DESIGNED BY ENGINEER PER PINELLAS COUNTY DETAIL INDEX NUMBER 1290.
10. FINAL DESIGN MUST INCLUDE A POSITIVE OUTFALL STRUCTURE.
11. A DRAW-DOWN ANALYSES SHOULD ACCOMPANY RAIN GARDEN DESIGN DETAILS TO ENSURE ADEQUATE HYDRAULIC BEHAVIOR.
12. MINIMUM UTILITY SETBACKS AND PROTECTION MEASURES MUST CONFORM TO CURRENT PINELLAS COUNTY STANDARDS. COORDINATE WITH UTILITY OWNER IN THE EVENT OF UTILITY CROSSING AND UTILITY CONFLICTS.
13. DESIGN ENGINEER MUST ENSURE FINAL DESIGN ADHERES TO ALL APPLICABLE COUNTY CODES.

PINELLAS COUNTY

RAIN GARDEN TEMPLATE

DETAIL INDEX I.D.:	---
DATE:	SEP/2020
	NOT TO SCALE
REVISION:	

Figure 4.13.1: Pinellas County CAD template for rain gardens

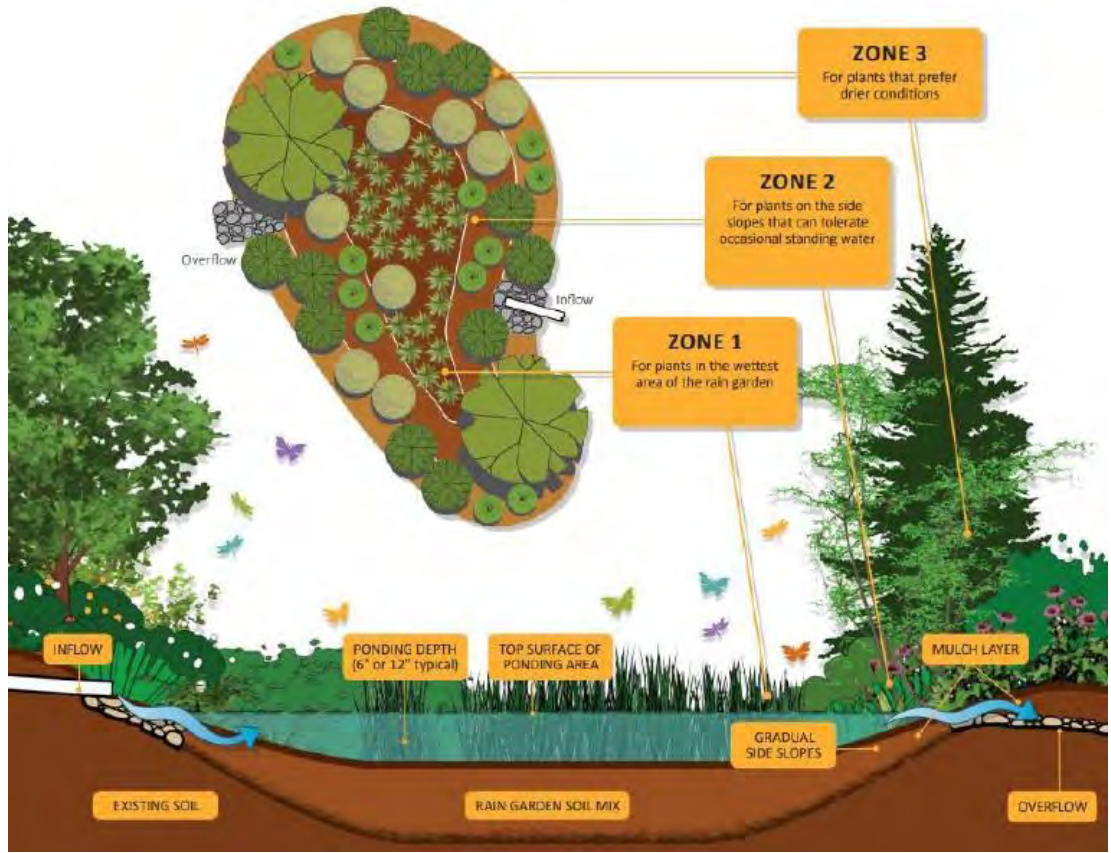

Figure 4.13.2: General concept for plant selection by zone (Image source: WSU Rain Garden Handbook of Western Washington)

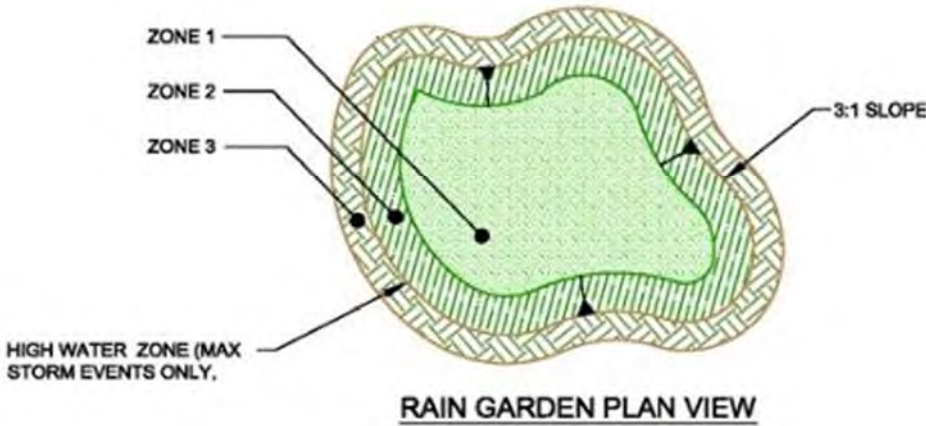

Figure 4.13.3: Rain garden plan view, provided by Applied Sciences, Inc.

Suggested Rain Garden Plants for Pinellas County		
	<i>Common Name</i>	<i>Botanical Name</i>
Flowers	African Iris	Dietes iridioides
	Blue Flag Iris*	Iris virginica
	Canna Lily	Canna spp.
	Goldenrod*	Solidago spp.
	Milkweed	Asclepias spp.
	Shrimp Plant	Justicia brandegeana
	Swamp Flower*	Helianthus angustifolius
Grasses & Shrubs	Florida gamma grass*	Tripsacum daniellii
	Muhly grass*	Muhlenbergia capillaries
	Wiregrass*	Aristida stricta var. beyrichiana
	Virginia Willow*	Itea virginica
Ground Cover	Holly Fern	Cyrtomium falcatum
	Periwinkle	Vinca major
	St. Bernard's Lily	Anthericum sanderii

Note: native plants are designated by an asterisk (*)

Other sources for plant selection:

[Pinellas County native plant – searchable/filterable list of suggested plants](#)

[Florida Friendly™ \(FFL\) plant selection guide](#)

4.13.4. Construction of the Rain Garden

1. **Lay out the garden** - Lay out the shape and boundary of the rain garden based on the design. Before digging contact your local organization that [locates underground utilities](#).
2. **Excavate the garden** - If appropriate, remove and reuse existing turf grass. Excavate to a depth of 18 to 24 inches. Use the soil to build a berm around the rain garden edges if necessary.
3. **Prepare the soil** - Install the desired soil/media mixture that includes 30 to 40 percent compost by volume. Mix in well. Refer to the Bioretention Media Supplemental Specification in APPENDIX I of this manual.
4. **Plant the flowers and grasses** - Follow the approved design and install plants in the approximate positions. Step back and look at the garden and the design. Plants should be placed about 1 foot apart from each other.
5. **Mulch the garden** - Use coarse, fibrous, shredded woodchips that won't float or blow away. Apply the mulch about two-to-three inches deep. This will help to keep the moisture in and the weeds out. Use [Florida-Friendly™ mulch](#) and avoid cypress mulch because it is made by chopping down cypress trees in wetlands.
6. **Water and ensure conveyance inflow** - After the rain garden is planted, water every other day for two weeks if it doesn't rain until garden looks to be growing on its own. Ensure that the conveyance system is delivering stormwater as desired and designed.

4.13.5. Inspection and Maintenance

(1)	A maintenance plan is required to be submitted with all other application materials. Inspection certifications (see the form in the appendices) should include an explanation of the maintenance performed and are required to be signed/sealed by a licensed professional engineer.
(2)	Inspect rain gardens at the beginning and the end of each rainy season. Remember that rain gardens are not completely maintenance-free. After the rain garden is planted and established it may seldom need watering except in the dry season and it should never need any type of fertilizer or pesticide.
(3)	It is important to weed, clean-up, and re-mulch the rain garden, as needed, in the early Spring and Fall.
(4)	During the first growing season, the most important maintenance is watering and weeding. A young garden will need about an inch of water per week until it is established.
(5)	All rain gardens need periodic weeding and replenishing of non-floating mulch. As the garden matures weeds will be pushed out by the growing plants. The mulch will need to be raked periodically and replenished or freshened every Spring.
(6)	Each Spring, clean-up the rain garden by removing any dead material and replenishing the mulch. In the fall it is important to remove some of the dead vegetation. Some of the material and seed-bearing plants may be left in place for birds.
(7)	Rain garden maintenance should follow the guidelines provided in the UF IFAS publications, "Rain Gardens: A Manual for Central Florida Residents" , and the "Florida Field guide to Low Impact Development: Bioretention Basins/Rain Gardens" Additional plant-specific maintenance and care guidelines should be included in the rain garden maintenance plan.
(8)	All landscape maintenance procedures shall adhere to the County's Landscape Maintenance and Fertilizer Use Ordinance .

4.14. Rainwater Harvesting

4.14.1. Description

Rain is a free source of relatively clean, soft water. As rain falls onto surfaces such as concrete, pavement, and grass it contacts more contaminants than it would from dry fallout on a roof. Harvesting rainwater from roof runoff is an easy, inexpensive way to disconnect impervious surfaces and capture water before it has contacted many potential contaminants. The harvested rainwater can be used for a variety of uses ranging from outdoor irrigation and car washing to indoor uses including toilet flushing, clothes washing, irrigation of indoor planters, hose bibs, car washing, and potable use. However, most of these indoor uses require approval of the [Pinellas County Health Department](#) and [Development Review Services Department](#).

There are four types of rainwater harvesting systems:

- Small residential systems that store rainwater in rain barrels for supplemental irrigation.
- Large residential or commercial systems that store rainwater in a cistern for irrigation, vehicle washing, dust control, or other outdoor, non-potable uses.
- Large residential or commercial systems that store rainwater in a cistern as a source of indoor graywater uses such as toilet flushing, urinal flushing, Heating Ventilating and Air Conditioning (HVAC) make-up water, laundry wash water, and outdoor non-potable uses.
- Residential or commercial systems that store rainwater in a cistern as a source of potable water.

RAINWATER HARVESTING SUMMARY

Advantages/Benefits	Reduces site DCIA, stormwater volume, pollutant loadings; reduces potable water use and reuses rainwater for irrigation and other non-potable purposes; provides ground water recharge and water reuse.
Disadvantages/Limitations	May require a pump, flow meter, and filtration system, depending on the determined uses of harvested rainwater.
Volume Reduction Potential	Moderate to High depending on roof area and storage volume
Pollutant Removal Potential	Moderate to High for all pollutants
Key design considerations	Only for managing roof runoff. Calculate roof area and annual stormwater volume; determine use for harvested rainwater (irrigation, graywater, potable); determine harvesting rate, volume, irrigation method, and equipment; obtain additional requirements for graywater or potable use from Pinellas County Health Department; recovery of treatment volume within 24 – 72 hours;
Key construction and maintenance considerations	Ensure underground cisterns or storage vaults are protected against buoyant forces;

1. **Type 1 - Non-potable Residential System with a Rain Barrel** - The first type of system is a small residential system that stores rainwater in rain barrels. These systems allow homeowners to retrofit their homes to reduce runoff and the amount of potable water consumed for irrigation. Many sources of information on designing and installing these systems are available on the internet:

- <http://www.scgov.net/EnvironmentalServices/Water/Rainbarrel.asp>
- <https://www.swfwmd.state.fl.us/residents/water-conservation/rain-barrels>
- <http://pcetimelytopics.blogspot.com/2009/05/rain-harvesting.html>

Information and rain barrels also are available at home centers. Although Pinellas County encourages the use of rain barrels by homeowners, they do not qualify for stormwater load reduction credits.

2. **Type 2 - Non-potable System for Outdoor Use with a Cistern** - The second type of system is a large commercial or residential system that uses a cistern or other permanent storage tank to store water for irrigation and/or other non-potable uses. In these systems:

- Rainwater is collected by gutters and scuppers and routed through downspouts to a cistern.
- The downspouts are equipped with a device to divert the first flush of water away from the cistern and to screen out large material such as leaves.
- Cisterns typically are larger than 80 gallons and may provide aboveground or underground storage. If the cistern is underground, it must be constrained against buoyant forces.
- The irrigation system will likely require additional filtration and screening to prevent valves and spray heads from clogging.
- The harvested rainwater will require a pumping system to distribute the water. The components for this type of system are shown below.

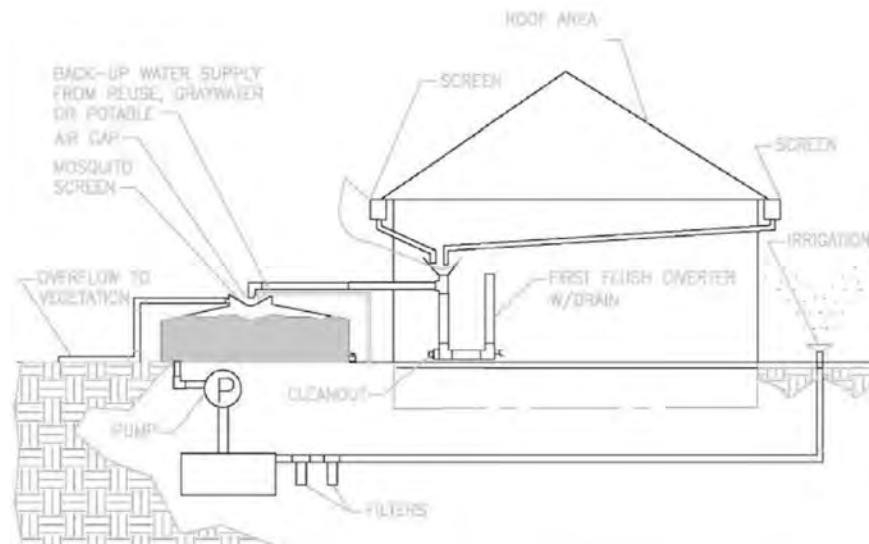

3. **Type 3 - Non-Potable System for Indoor and Outdoor Use with a Cistern** - The third type of system is a large residential or commercial system that stores rainwater in a cistern for indoor uses such as toilet flushing, urinal flushing, HVAC make-up water, laundry wash water, and other outdoor uses. In these systems:

- Rainwater is collected by gutters and scuppers and routed through downspouts to a cistern.
- The downspouts are equipped with a device to divert the first flush of water away from the cistern and to screen out large material such as leaves.
- Cisterns are larger than 80 gallons and may provide aboveground or underground storage. If the cistern is underground, it must be constrained against buoyant forces.
- The harvested rainwater will require a pumping system to distribute the water.
- Indoor graywater (flushing and laundry) systems require pre-filtering and fine filtering to between 5 and 20 microns.

This type of system has a potential for inadvertent human contact or consumption; therefore, the system has additional requirements from the [Pinellas County Health Department](#). The components for this type of system are shown below.

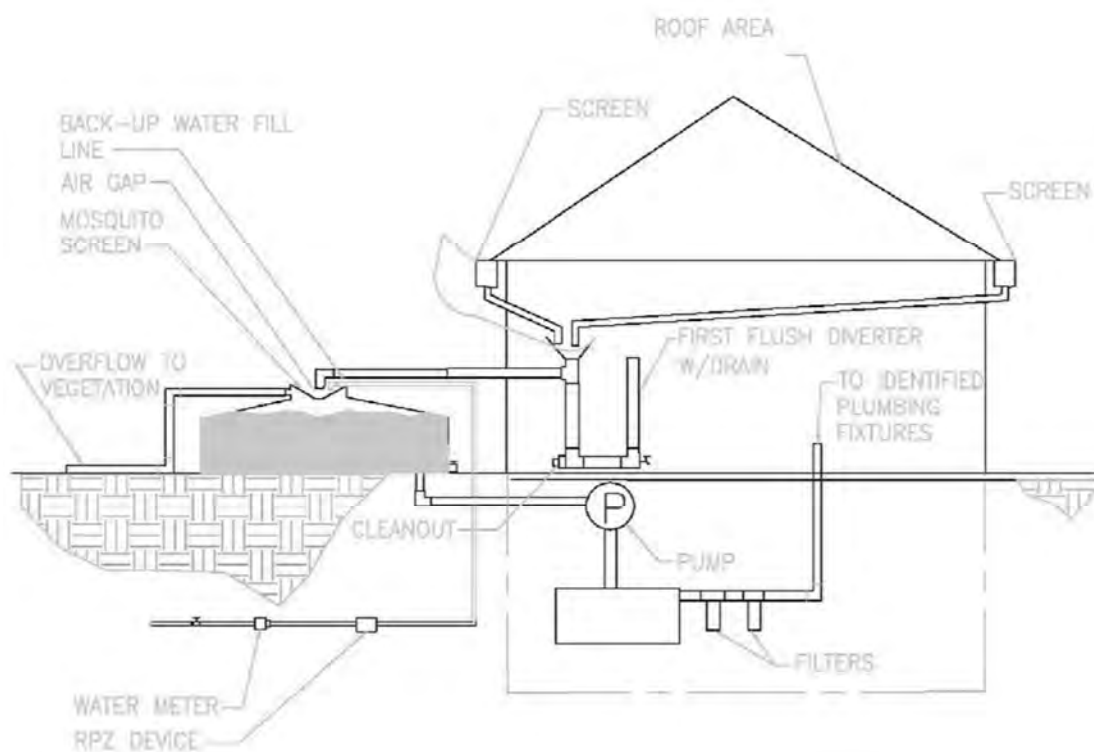

4. **Type 4 - Potable Use with a Cistern** - The fourth type of system is a residential or commercial system that stores rainwater in a cistern as a source of potable water. This type of system is designed for human consumption. Therefore, the system has additional design, operating, and permitting requirements from the [Pinellas County Health Department](#).

4.14.2. Applicability and Siting Considerations

A Rainwater Harvesting System is primarily designed to store and supply roof rainwater for use in lieu of high-quality potable water. They can be used on commercial, residential, and industrial areas. The cistern storage volume provides stormwater benefits along with non-potable water than can be used for numerous purposes. Due to the relatively small volume of roof runoff and the extreme variations in storm intensity and duration, rainwater harvesting does not provide peak discharge rate attenuation. While rain is a relatively

clean source of water, the initial runoff from a roof can contain dust, fecal material, and particulate matter that accumulate on the roof. Asphalt roof shingles can be a source of contaminants as well (as opposed to metal roofs). This initial runoff is diverted from the cistern by the first-flush diverter. Rainfall is a source of nitrogen from atmospheric deposition. Harvesting rainfall results in a reduction in the nitrogen load as well as other pollutants. To achieve a desired average annual load reduction, the cistern must be designed with the target annual average volume reduction, harvesting rate, and water use rate, in mind.

The roof must have gutters or drains with the appropriate screens to collect the rainwater. The site must have adequate space for a cistern and may need to be anchored to a structure. There must be a use for the harvested rainwater. A makeup water source may be required for periods of low rainfall. Stormwater and graywater (including air conditioner condensate) are the first choices for irrigation systems. Make-up water within an occupied space will likely be potable water. Potable water supplies must be separated using a backflow prevention device. An air gap is preferred.

4.14.3. Required Treatment Volume



Since a Rainwater Harvesting System is only used to capture roof runoff, a relatively small part of the overall runoff in a development, it functions as a component of a BMP Treatment Train. Accordingly, it will only provide part of the required pollutant load reduction. The rainwater harvesting storage volume may be determined by calculating the volume of water necessary to sustain the desired water use: irrigation, graywater, or potable water supply. The applicant will size the cistern to satisfy the water-use demand. Using the calculated cistern volume, the applicant may then calculate the harvesting rate normalized to the roof catchment area. This volume is used to determine a runoff-capture efficiency using the curve provided in Figure 4.15.1. It should be noted that Figure 4.15.1. is a Rate Efficiency Volume (REV) curve for a constant daily water demand in Pinellas County. If the daily demand is expected to vary by more than ten percent, either the lowest expected daily demand must be used on Figure 4.15.1. or the average annual reduction in runoff from the roof must be demonstrated using a continuous simulation based on at least 20 years of rainfall data.

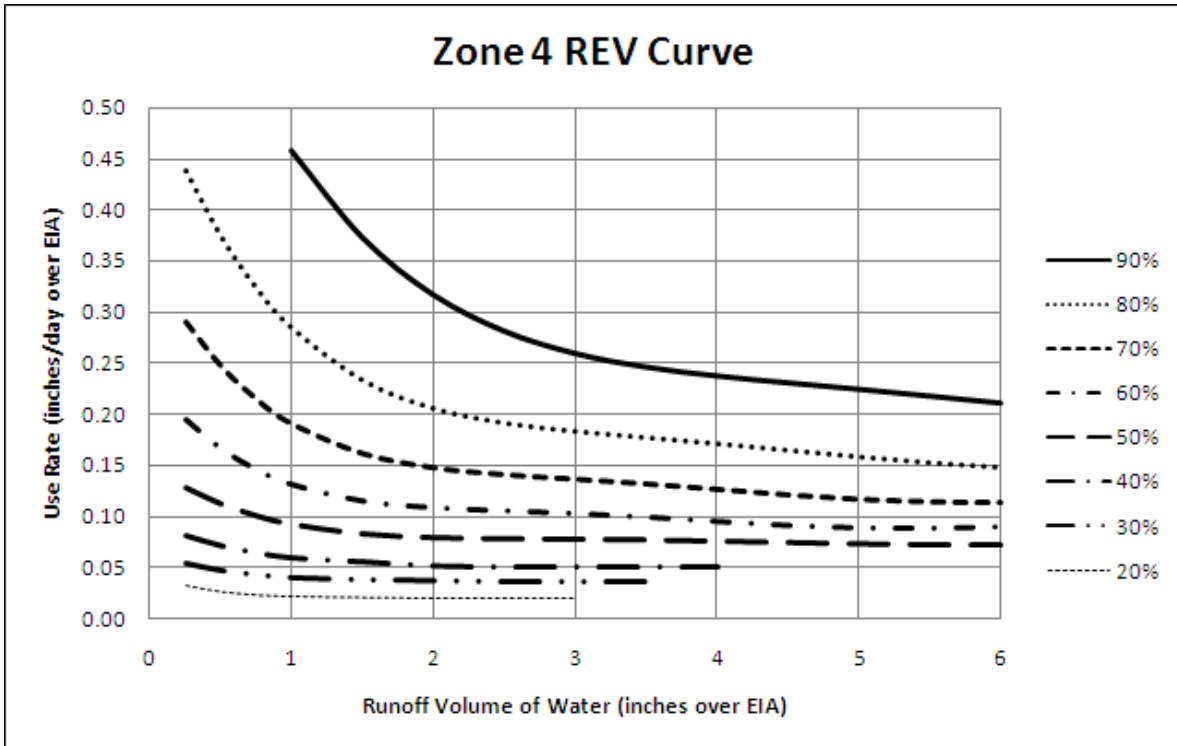

4.14.4. Design Criteria

The following criteria are considered minimum standards for the design of a rainwater harvesting system for stormwater credit in Pinellas County. The applicant should consult with the [SWFWMD](#), the [Florida Building Code](#) for Plumbing (Florida, 2014), or its successors, and the [Pinellas County Health Department](#) to determine if there are any variations to these criteria or additional standards that must be followed.

1. Catchment System

- a. The gutters, downspouts, drains, and pipes for the collection system must be directed to a cistern.
- b. Gutters and drains must be protected and covered with a removable screen to prevent debris from clogging drains.
- c. For every inch of rain that falls on a roof area of 1,000 square feet, approximately 600 gallons of rainwater may be collected. One inch of rain falling on a square foot surface yields approximately 0.6 gallons of water. As a result of water loss in the system, it is estimated that about 75% of the harvested rainfall can be captured or 0.46 gallons.
- d. The first flush of rainwater, equivalent to the first gallon of runoff per 100 square feet of roof area, must be discarded after each rain event to ensure only the cleanest water is stored in the cistern. This is accomplished by installing a first flush diverter before the cistern, typically within the downspout. The diverted rainwater is routed to a vegetated area such as a rain garden. Several manufacturers offer proprietary first-flush diverters; some of these diverters use a vortex to

separate debris while reducing the need for maintenance. A schematic of a simple first-flush diverter is shown below.

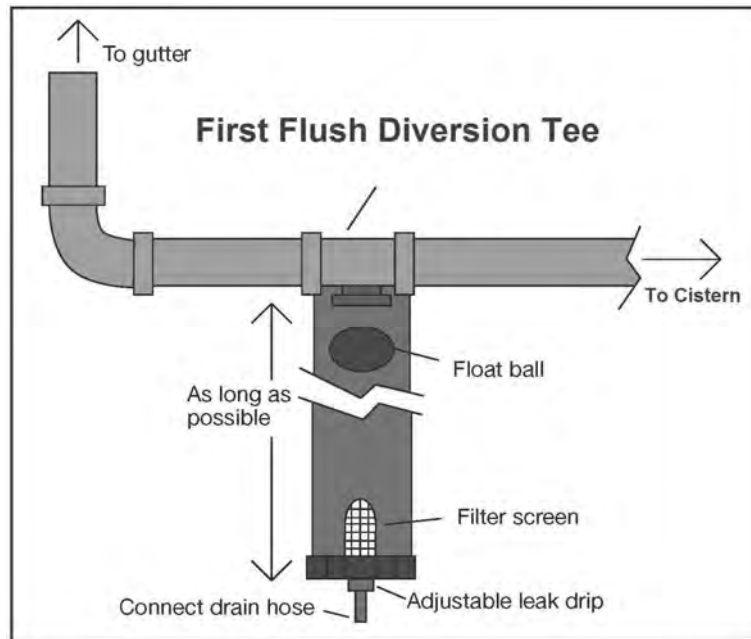

2. Filtering System

- a. Irrigation systems require pre-filtering to remove particles that may affect valve and sprinkler operation. The filtering system should be designed in accordance with the requirements of the irrigation system.
- b. Indoor graywater (flushing and laundry) systems require pre-filtering and fine filtering to between 5 and 20 microns.

3. Cistern

- a. The cistern may be installed below or above ground. If aboveground storage is used, it must be UV stable. The cistern must inhibit algal growth without biocides or toxic substances. This criterion may be met simply with an opaque tank.
- b. The installation must follow the [Florida Building Code](#) for Plumbing and the [Florida Building Code](#) for Electrical.
- c. Prevention of unintentional entry by humans or vermin must be part of the design. Also, inspection and cleaning access with venting and appropriate safety signs must be provided.
- d. The water supply line (e.g., irrigation line or graywater line) must be metered and have a filter.
- e. An overflow drain is required. It must be sized to accommodate the 100-year/ 24-hour design storm flows. The appropriate downstream erosion controls must be made.
- f. The cistern size (dedicated water volume) must be determined based on the water use.
- g. An auxiliary back-up water supply must be provided. Graywater (including air conditioner condensate) is preferred for irrigation systems, but other sources should be considered. If reclaimed water is used, it must be fully used during the intended irrigation cycle and proper

signage should be added.

4. Irrigation system

- a. Irrigation water is supplied from a cistern.
- b. Irrigation rates and timing must comply with current watering restrictions.
- c. Rain sensors or soil moisture sensors for irrigation shut off must be provided.
- d. Watering restrictions are applicable to irrigations systems supplied with rainwater.
- e. Backflow prevention devices on any auxiliary back-up source must be provided.

5. Graywater system

- a. Asphalt shingles and cedar shakes may not be used as a roofing material for the catchment area for a graywater or potable water system. These materials can leach potentially toxic materials such as copper oxide and petroleum products. (Texas, 2007)
- b. Harvested rainwater is supplied from a cistern for graywater use within an occupied space.
- c. Filters are required between the pump and the connection to the plumbing system to provide pre-filtering and fine filtering to between 5 and 20 microns.
- d. Backflow prevention devices on any auxiliary back-up source must be provided.
- e. All Rainwater Harvesting Systems connecting to a plumbing system within an occupied space must be approved by the [Pinellas County Health Department](#) and the [Pinellas County Development Services](#). These systems may have additional design and maintenance requirements.

6. Discharge Requirements - A Rainfall Harvesting System typically will have two discharges: the water diverted from the first flush and the cistern overflow. The appropriate erosion control must be made downstream of both discharges. Where possible, the first-flush water must be discharged to a rain garden or other landscaped area.

7. Safety Considerations - Safety considerations to be addressed for all rainwater harvesting designs include but are not limited to the following:

- a. Access to the pump and cistern must be controlled.
- b. Safety features may include fencing and signage depending on the site and use of water.
- c. Depending on the end use, electrical back-up when power is down is recommended as part of emergency operations.
- d. All pipes that transport water for harvesting must be labeled as 'Non-potable. Do not drink.' unless the system is approved by the [Pinellas County Health Department](#) for potable use.
- e. Large cisterns and vaults may require entry for maintenance and inspection.
- f. These systems must provide appropriate safety equipment for a confined space.
- g. The Rainwater Harvesting System must be separated from the potable water supply with a backflow prevention device, preferably consisting of an air gap.

8. **Additional Design Considerations** - A Rainfall Harvesting System may include the following, depending on the system's design:

- a. Lighting and electrical outlets.
- b. Signage with education and safety language.
- c. A leak detection system for the cistern.

9. **Additional Permitting Considerations**

- a. The rainwater harvesting system may require a [SWFWMD water use permit](#).
- b. The rainwater harvesting system may require a permit from the [Pinellas County Health Department](#).
- c. The rainwater harvesting system will require a permit from the [Pinellas County Development Services](#) to include electrical, plumbing, and structure anchoring.

4.14.5. Construction Requirements

Rainwater harvesting systems typically are used in conjunction with rain gardens and secondary water uses such as irrigation. To assure proper construction of the stormwater harvesting system the following construction procedures are required:

- 1. Install the Catchment System including the gutters, screens, diverter, and cistern.
- 2. Construct the rain garden or landscaping area that will receive the first flush discharge and ensure that it is stabilized with appropriate vegetation before operation begins.
- 3. Construct the associated irrigation system in accordance with all permitted design specifications and irrigation system design standards. If appropriate, construct the components of the non-potable or potable uses for rainwater in accordance with all design and code specifications.
- 4. Assure that all irrigation components are properly sited and that irrigation spray heads are working properly and not spraying irrigation water onto impervious areas.
- 5. Test all components of the system to ensure there are no leaks or other malfunctions.

4.14.6. Inspection, Operation, and Maintenance

Maintenance issues associated with Rainwater Harvesting Systems are related to the proper functioning of the filter system and of the pump and irrigation system. Rainwater Harvesting Systems must be inspected regularly by the operation and maintenance entity to determine if it is operating as designed and permitted. Reports documenting the results of annual inspections will be filed with the County every two years.

1. Inspection Items:

(1)	Inspect operation of the Rainwater Harvesting System to assure that the pump, flow meter, and filter system are operating properly and achieving desired flow volumes.
(2)	Inspect the operation of the Rainwater Harvesting System to assure proper operational and, with respect to the irrigation system, inspect the pump, timer, distribution lines, and sprinkler heads to assure they are working properly.

2. Maintenance Activities As-Needed To Prolong Service:

(1)	Repair any components of the Rainwater Harvesting System that are not functioning properly and restore proper flow and filtration of stormwater.
-----	--

- | | |
|-----|---|
| (2) | Repair or replace any damaged components of the Rainwater Harvesting System and irrigation system as needed for proper operation. |
|-----|---|

3. Record keeping

The owner/operator of a Rainwater Harvesting System must keep a maintenance log of activities that is available at any time for inspection or recertification purposes. The log will include records related to the operation of the Rainwater Harvesting System and the use of the harvested rainwater for irrigation or other approved purposes to demonstrate that the permitted nutrient load reduction is being achieved. A totalizing flow meter to measure the quantity and day/time of pumping and irrigation is required. The maintenance log will include the following:

- a. Rainwater volume harvested using a flow meter specifying the day, time, and volume;
- b. Rainwater volume irrigated or otherwise used using a flow meter specifying the day, time, and volume used;
- c. Observations of the Rainwater Harvesting System operation, maintenance, and a list of parts that were replaced;
- d. Observations of the irrigation system operation, maintenance, and a list of parts that were replaced; and
- e. Dates on which the Rainwater Harvesting System and irrigation (or other use systems) were inspected and maintenance activities conducted.

4.15. Rainfall Interceptor Trees

4.15.1. Description

Interceptor trees are those trees used in urban land uses adjacent to impervious surfaces as part of the stormwater treatment system to reduce runoff volume and pollution from the area. Trees intercept storm water and retain a significant volume of the captured water on their leaves and branches allowing for evaporation and providing runoff reduction benefits. For example, a large oak tree can intercept and retain more than 500 to 1,000 gallons of rainfall in a given year (Cappiella, 2004). While the most effective Interceptor Trees are large canopied evergreen trees, deciduous trees can also provide a benefit. For example, a leafless Bradford pear will retain more than one half the amount of precipitation intercepted by an evergreen cork oak (Xiao et al., 2000). Interceptor trees are an important component of urban reforestation and therefore also help to reduce the heat island effect.



INTERCEPTOR TREES SUMMARY

Advantages/Benefits	Reduces stormwater volume by intercepting rainfall and preventing it from hitting impervious surfaces; reduces heat island effect; reduces potable water use and reuses stormwater for irrigation; can be used within parking lot islands; can be used for new trees or existing trees.
Disadvantages/Limitations	Trees must be within 15 feet of impervious area; must provide adequate uncompacted and aerated soils for tree survival.
Volume Reduction Potential	Low to Moderate depending on number of trees and canopy cover of impervious surfaces.
Pollutant Removal Potential	Low to Moderate, directly related to reduction in stormwater volume.
Key design considerations	Determine locations for trees; select or protect desired tree species; ensure at least 1,000 cubic feet of uncompacted soil volume per tree;
Key construction and maintenance considerations	Prevent soil compaction and contamination from construction related materials; plant trees following guidelines; protect existing trees with proper barriers; install irrigation per specification' mulch with Florida-Friendly™, non-floating hardwood chips; prune trees as needed; replace mulch as needed.

4.15.2. Applicability and Siting Considerations

1. **Soils:** Drainage and soil type must support selected tree species. Must have sufficient soil volume to allow a tree to grow to its mature size. In general, a large-sized tree (16 inches diameter) needs at least 1,000 cubic feet of uncompacted soil.
2. **Location:** Locate within an impervious surface (such as within landscape islands within parking lots or tree planters within plazas) or within 15 feet of an impervious surface (as close as practical depending on the tree species). Alternatively, the location is consistent with the requirements for Street Trees in [Section 138-3657 of Article X of the Community Design Standards](#).
3. **Other structures:** Maintain appropriate distance from infrastructure and structures that could be damaged by roots and avoid overhead power lines, underground utilities, septic systems, sidewalks, curbs, patios, etc.
4. **Advantages:** Interceptor trees reduces the volume of rainfall that land on impervious surfaces and become stormwater. This helps to reduce the total stormwater volume and the stormwater pollutant loading entering the storm drain system and can reduce the size of downstream stormwater systems. Interceptor trees also provide for enhanced aesthetic value, provides shade to cool pavement and reduces surface runoff temperatures, aids in removal of air pollutants and noise reduction, and provides potential LEED Credits.

4.15.3. Stormwater Treatment Credits

The basic stormwater treatment mechanism associated with interceptor trees is the reduction in stormwater volume associated with the interception of the rainfall by the trees. The credits set forth below are based on the research conducted by New College in Sarasota County during 2006 to document rainfall interception by oaks, pines, and palm trees (Final report, NOAA Award NA03NMF4720538) and an interpretation of the data undertaken by Steve Suau, P.E., who worked for Sarasota County during the study. Based on this study, a provisional rainfall interception value is established below:



Provisional Rainfall Interception Values

TREE TYPES	NEW TREES INTERCEPTION CREDIT	EXISTING TREES INTERCEPTION CREDIT
Oaks or similar species	13%	18%
Pines or similar species	10%	15%
Palms or similar species	8%	13%

The volume, TN, and TP load reduction credits associated with new interceptor trees is calculated as follows:

- a. Determine the impervious surface area that the canopy of the tree(s) will cover in 20 years.
- b. Determine the percent of interception credit by tree type from the above table
- c. Calculate the annual rainfall volume reduction = A * R* Interception % * Conversion
Area (in acres)(51 in/yr)(Interception %)(1 ft/12 inches) = Volume in acre-feet
- d. For new trees, apply a safety factor of two to the volume or divide the rainfall reduction by two.
- e. Calculate TN and TP load reductions by multiplying the volume times the EMCs listed in Table 6.10.3.

To calculate the load reduction credit when existing trees are used for interception credit, follow the above process but do not apply a safety factor of two.

4.15.4. Design Criteria

1. **Site applicability:** For residential development on private property, interceptor tree credit can only be used at sites larger than 5,000 square feet. For all sites including right-of-way with over 1,000 square feet of impervious surface to manage, no more than ten percent of the impervious area can be mitigated through the use of trees.
2. **New tree sizing:** New trees on private property must be at least 2.0 caliper inches at the time of planting, and new coniferous trees must be at least ten feet tall to receive credit. The size of the tree should require at least a 10 to 15 gallon container.
3. **New tree setbacks:** New trees will be planted within 15 feet of impervious surfaces such that their canopy covers impervious surface areas. Siting of trees will ensure that the root system is not harmed by proximity to impervious surfaces. Trees must be spaced such that the crowns do not overlap at maturity.
4. **Existing tree sizing and setbacks:** Credit also applies to existing trees kept on a site if the trunk is within 15 feet of impervious surfaces and are at least 4.0 inch caliper or larger. Caliper is the diameter of the tree measured at breast height.
5. **Tree selection:** The trees selected will be [Florida-friendly™](#) suitable species for the site conditions and the design intent. The Pinellas County Approved Plant List is found in [Section 138-3664 of Article X Community Design Standards](#). Nuisance trees or trees in referenced in [Section 138-3653.a \(Undesirable Trees/Plant List\)](#) cannot receive stormwater tree credit. Pinellas County may require a certified arborists report to verify suitable tree selection and preservation.
6. **Planting sites:** Ideal planting sites within a development are those that create interception opportunities around impervious surfaces. These include areas along pathways, roads, islands and median strips, and parking lot interiors and perimeters. It is important to evaluate and record the

conditions, such as soil type, soil pH, soil compaction, and the hydrology of proposed planting sites to ensure they are suitable for planting. These evaluations provide a basis for species selection and determination of the need for any special site preparation techniques.

A minimum of 1,000 cubic feet of uncompacted, rootable soil volume must be provided per tree. In planting arrangements that allow for shared rooting space amongst multiple trees, a minimum of 1,000 cubic feet of rootable soil volume must be provided for each tree. Rootable soil volume must be within 3 feet of the surface.

Site characteristics determine what tree species will flourish there and whether any of the conditions, such as soils, can be improved through the addition of compost or other amendments. Table 4.15.1. presents methods for addressing common constraints to urban tree planting.

<i>Potential Impact</i>	<i>Potential Resolution</i>
Limited Soil Volume	Provide 1,000 cubic feet of rootable soil volume per tree (this soil must be within 3 feet of the surface) Use planting arrangements that allow shared rooting space. A minimum of 1,000 cubic feet of rootable soil volume must be provided for each tree in shared rooting space arrangements.
Poor Soil Quality	Test soil and perform appropriate restoration Select species tolerant of soil pH, compaction, drainage, etc. Replace very poor soils if necessary
Air Pollution	Select species tolerant of air pollutants
Damage from Lawnmowers	Use mulch (non-floating) to protect trees
Damage from Vandalism	Use tree cages or benches to protect trees Select species with inconspicuous bark or thorns Install lighting nearby to discourage vandalism
Damage from Vehicles	Provide adequate setbacks between vehicle parking stalls and trees
Damage from animals such as deer, rodents, rabbits, and other herbivores	Use protective fencing or chemical retardants
Exposure to pollutants in stormwater and snowmelt runoff	Select species that are tolerant of specific pollutants, such as salt and metals
Soil moisture extremes	Select species that are tolerant of inundation or drought Install underdrains if necessary Select appropriate backfill soil and mix thoroughly with site soil Improve soil drainage with amendments and tillage if needed
Increased temperature	Select drought tolerant species
Increased wind	Select drought tolerant species
Abundant populations of invasive species	Control invasive species prior to planting Continually monitor for and remove invasive species

Conflict with infrastructure	Design the site to keep trees and infrastructure separate Provide appropriate setbacks from infrastructure Select appropriate species for planting near infrastructure Use alternative materials to reduce conflict
Disease or insect infestation	Select resistant species

Planting trees at development sites requires prudent species selection, a maintenance plan, and careful planning to avoid impacts from nearby infrastructure, runoff, vehicles or other urban elements.

- 7. Trees Along Streets and in Parking Lots.** When considering a location for planting clear lines of sight must be provided, as well as safe travel surfaces, and overhead clearance for pedestrians and vehicles. Also, ensure enough future soil volume for healthy tree growth. At least two cubic feet of useable soil per square foot of average mature tree canopy is required. (Useable soil must be uncompacted and may not be covered by impervious material). Having at least a six foot wide planting strip or locating sidewalks between the trees and street allows more rooting space for trees in adjacent property.

Select tree species that are drought tolerant, can grow in poor or compacted soils, and are tolerant to typical urban pollutants (oil and grease, metals, and chlorides). Additionally, select species that do not produce excessive fruits, nuts, or leaf litter, that have fall color, spring flowers or some other aesthetic benefit, and can be limbed up to six feet to provide pedestrian and vehicle traffic underneath. The [Pinellas County Extension Service](#) and the Florida Yards Program can provide guidance on preferred street tree species

- 8. Planting Techniques.** Prepare a hole no deeper than the root ball or mass but two to three times wider than the spread of the root ball or mass. The majority of the roots on a newly planted tree will develop in the top 12 inches of soil and spread out laterally.

Proper handling during planting is essential to avoid prolonged transplant shock and ensure a healthy future for new trees and shrubs. Trees should always be handled by the root ball or container, never by the trunk. Specifications for planting a tree are illustrated below. Trees must be watered well after planting.

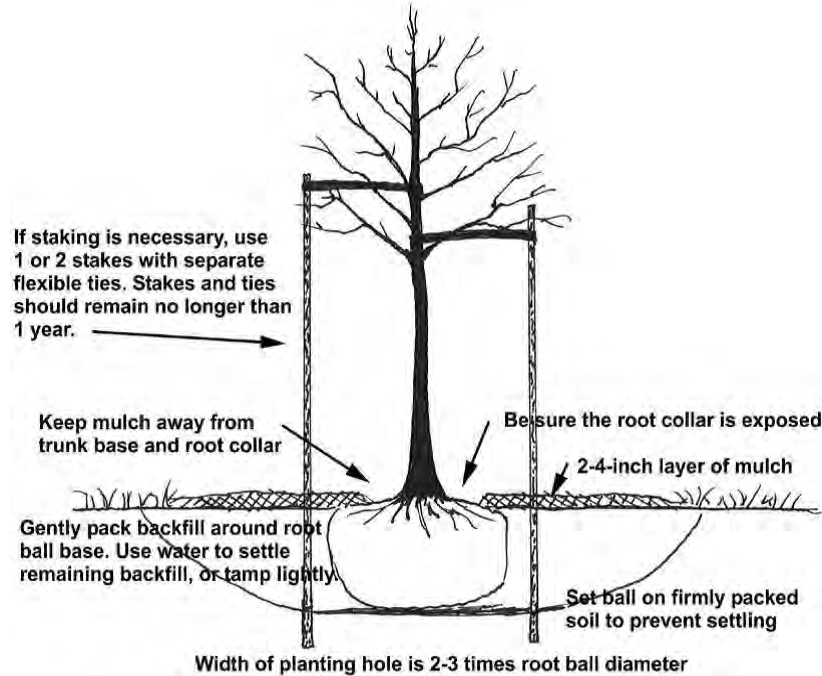

Figure 4.15.1. Tree planting guidelines. (Adapted from Flott, 2004 and ISA, 2003b).

9. Post-Planting Tree Protection. Once the tree has been properly planted, two-to-four inches of organic [Florida-Friendly™ mulch](#) (non-floating) must be spread over the soil surface out to the drip line of the tree. If planting a cluster of trees, mulch the entire planting area. Slow-decomposing organic mulches, such as shredded bark, compost, leaf mulch, or wood chips provide many added benefits for trees. Mulch that contains a combination of chips, leaves, bark, and twigs is ideal for reforestation sites. Grass clippings and sawdust are not recommended as mulches because they decompose rapidly and require frequent application, resulting in reduced benefits.

For well-drained sites up to four inches of mulch may be applied, and for poorly drained sites a thinner layer of mulch should be applied. Mulch should never be more than four inches deep or applied right next to the tree trunk; however, a common sight in many landscaped areas is the —mulch volcano. This over-mulching technique can cause oxygen and moisture-level problems, and decay of the living bark at the base of the tree. A mulch-free area, two-to-three inches wide at the base of the tree, must be provided to avoid moist bark conditions and prevent decay (ISA, 2003a).

10. Limitations: Tree credits may not be allowed if site circumstances or system limitations exist.

4.15.5. Construction considerations

1. New trees

- Do not allow soil in planter areas to be compacted during construction.
- Do not allow soil in planter areas to become contaminated with construction related materials such as lime or limestone gravel, concrete, sheetrock, or paint.
- Install irrigation system according to proper specifications.
- When installing lawn around trees, install the grass no closer than 24 inches from the trunk.

- Install protective fencing if construction is ongoing, to avoid damage to new trees.
- Mulch with [Florida-Friendly™, non-floating](#) hardwood chips four-to-six inches installed depth (two-to-three inches settled depth).
- Do not use pressure treated stakes. Do not stake into or through the root ball. Stakes should be set perpendicular to the prevailing wind. Stakes should be cut off one-to-two inches above the highest tree tie.

2. Existing trees

- Proposed development plans and specifications must clearly state protection procedures for trees that are to be preserved.
- Existing trees must be protected during construction as required by [Section 138-3654, Tree Protection and Relocation](#). High-visibility construction fencing must be set at the outer limit of the critical root zone. The fence must prevent equipment traffic and storage under the trees. Excavation within this zone should be accomplished by hand, and roots 1/2 inch and larger should be preserved. It is recommended that pruning of the branches or roots be completed by, or under the supervision of, an arborist.
- Soil compaction under trees must be avoided.
- Ensure that trees that receive irrigation continue to be watered during and after construction.

4.15.6. Interceptor Tree Inspection Requirements

An initial inspection by a qualified professional (ISA certified arborist) must be done to ensure the tree has been planted, watered, and protected correctly with locations flagged if appropriate. For newly planted trees, transplant shock is common and causes stress on a new tree. For this reason, newly planted trees must be inspected more frequently than established trees. The time it takes for a tree to become established varies with the size at planting, species, stock, and site conditions, but generally, trees should be inspected every few months during the first three years after planting, to identify problems and implement repairs or modify maintenance strategies.

After the first three years, annual inspections are sufficient to check for problems. Trees must also be inspected after major storm events for any damage that may have occurred. The inspection should take only a few minutes per tree, but prompt action on any problems encountered results in healthier, stronger trees. Inspections should include an assessment of overall tree health, an assessment of survival rate of the species planted, cause of mortality, if maintenance is required, insect or disease problems, tree protection adjustment, and weed control condition.

4.15.7. Interceptor Tree Maintenance Requirements

Water newly planted trees regularly (at least once a week) during the first growing season. Water trees less frequently (about once a month) during the next two growing seasons. After three growing seasons, water trees only during drought. The exact watering frequency will vary for each tree and site.

A general horticultural rule of thumb is that trees need one inch of rainfall per week during the growing season. Water trees deeply and slowly near the roots. Light, frequent watering of the entire plant can actually encourage roots to grow at the surface. Soaker hoses and drip irrigation work best for deep watering of trees. It is recommended that slow leak watering bags or tree buckets are installed to make watering easier and more effective. Continue watering until mid-fall, tapering off during lower temperatures.

Pruning is usually not needed for newly planted trees but may be beneficial for tree structure and safety purposes. If necessary, prune only dead, diseased, broken or crossing branches at planting. As the tree grows, lower branches may be pruned to provide clearance above the ground, or to remove dead or damaged limbs. Trees that are removed or die should be replaced with similar species, or all water quality benefits will be lost. The property owner is responsible for all costs associated with the replacement of interceptor trees.

Summary of Inspection and Maintenance for Interceptor Trees	
Removal of Leaves and Debris	Fallen leaves and debris from tree foliage should be raked and removed regularly to prevent the material from being washed into the storm water. Nuisance vegetation around the tree should be removed when discovered. Dead vegetation should be pruned from the tree on a regular basis.
Pruning	It is recommended that a certified arborist or similarly qualified professional be retained to prune trees, or the property owner should learn proper pruning methods. A tree should never be topped. Topping is the practice of removing major portions of a large tree's own crown by cutting branches to stubs or to the trunk. Tree topping shortens the life of the tree, creates weakly attached limbs prone to breakage, decay and disfigures the tree. It also eliminates the interception canopy.
Mulching	Add four-to-six inches deep of Florida-Friendly™, non-floating hardwood mulch around newly planted trees and shrubs (avoid redwood and cedar, it is light and blows away and does not decompose fast enough to be beneficial to the soil health and tree's growth).
Irrigation	An irrigation system should be installed at the time of planting and maintained during the establishment period or, if necessary to maintain the tree, in perpetuity.
Pesticides and Fertilizers	Minimize the use of chemicals to only what is necessary to maintain the health of the tree. Consider using mulch around the base of the tree as a substitute to fertilizer. Do not place mulch within six inches of the trunk of the tree.
Lawn Maintenance	Keep lawn at least 24 inches from truck of tree. Competition from turf grass stunts tree growth, and even additional fertilizer and water will not overcome this effect. A bare area around the truck also helps prevent injury to the tree from a mower or string trimmer. Trunk wounds to a young tree can have a severe dwarfing effect.
Other Activities	Plant evergreen shrubs and ground covers around the trees when possible. Care should be taken when digging near tree roots. Once tree has become established, planting of vegetation near base of tree and subsequent watering of vegetation may result in over-saturation and damage to the tree.
Removal/Replacement	See Long-term Maintenance.

4.15.8. Submittal Requirements

Interceptor Trees to be given credit as a stormwater volume and pollutant load reduction technique will be clearly labeled as such, with the size and species included. The impervious surface area for which they will intercept rainfall must be shown along with its size. Approximate setbacks from property lines, structures, and underground utilities will be shown. Street trees planted less than ten feet from an underground utility line require the installation of a tree root guard. Temporary irrigation measures will be shown, if applicable. A note will be included on the permit drawings that call for County inspection after the tree has been planted, or in the case of existing canopy, after the site grading has been completed. Trees proposed for stormwater credit will need to be included in the required stormwater system O&M Plan. Pinellas County may require a survey and certified arborist report to verify suitable tree selection or tree preservation for any trees designated for stormwater tree credit.



PINELLAS COUNTY
STORMWATER MANUAL
PART C - DESIGN GUIDE



Chapter 5 – Background Information

5.1. Purpose and Intent

The Pinellas County Stormwater Manual (Manual) is intended to be used primarily by professionals engaged in planning, designing, constructing, operating, and maintaining stormwater management systems in conjunction with capital and development projects in Pinellas County, as well as projects that directly discharge into the County stormwater system, for the purpose of meeting the water quantity and water quality requirements of the County's Land Development Code Potential users include, but are not limited to, stormwater design engineers, stormwater utility staff, natural resource managers, planning officials and administrators, building officials, architects, landscape architects, site design specialists, and landscape operations /maintenance professionals.

5.2. Stormwater Introduction

This Manual provides criteria, technical guidance, and design specifications for stormwater management systems requirements pertaining to both water quality and quantity. The Manual highlights stormwater best management practices (BMPs) used to treat stormwater runoff, in compliance with applicable Pinellas County codes designed to prevent discharges that cause or contribute to violations of State water quality standards.

The impact of both the Municipal National Pollutant Discharge Elimination System (NPDES) permit requirements, the number of impaired water bodies with Total Maximum Daily Loads (TMDLs) within Pinellas County, and the fact that the waters surrounding the County are designated as aquatic preserves by the State, create an even greater need to reduce stormwater pollutant loads and improve water quality, wetland, and habitat conditions. Additionally, the County recognizes that non-conventional stormwater management practices are essential to encourage and support quality redevelopment, which is critical to sustaining the local economy. The Municipal NPDES permit program requires jurisdictions to revisit their land development codes to ensure they promote green infrastructure to effectively support water quality improvement goals. This Manual addresses that requirement and closely follows the Pinellas County Comprehensive Plan's holistic approach to resource management and integrated/synergistic review of stormwater, flood control, wetland, and habitat protection and enhancement considerations. In a built-out landscape such as Pinellas County's, each redevelopment project provides an opportunity to incrementally contribute to meeting those goals while growing a sustainable economy supported by a quality community. When the economic, social, and environmental aspects of a project are considered together (the triple bottom line), the result is something that benefits all parties and provides an enhanced quality of life.



Triple Bottom Line Diagram

The Pinellas County Stormwater Manual functions as a toolbox (see table 6.1) of nonstructural and structural

stormwater best management practices (BMPs) that can be applied to a variety of redevelopment and development opportunities to satisfy regulatory standards. As many of the receiving waters in Pinellas County are impaired for certain pollutants, a load reduction approach to reducing stormwater pollutants discharged from the site is a major focus of this manual.

5.3. Local Context

Inland area, Pinellas County is relatively small with only 280 square miles of land area but with a population of nearly one million permanent residents, Pinellas County is the most densely populated county within the state. Pinellas County is nearly built out. As a result, the land development focus has shifted from the “greenfield” development approach commonly utilized in areas where large tracts of undeveloped land still exist, to an urban infill framework that focuses on development and redevelopment of previously-developed tracts of land.

Much of the county had experienced its first wave of development by the 1970s, well before stormwater and habitat/wetland management regulations were in place. Therefore, providing stormwater treatment and, where needed, enhanced flood protection during redevelopment is critical for Pinellas County to address its stormwater infrastructure needs, reduce stormwater pollutant loadings, restore impaired waters, and enhance wetlands and wildlife habitats and address the challenges of rising seas and a changing climate. Infill and redevelopment projects tend to be space-limited and the use of conventional stormwater treatment practices is often too land-intensive to accomplish required stormwater management objectives. In such cases, smaller-scale green infrastructure, either alone or more typically in combination with conventional treatment practices, may provide a more viable alternative to a more limited menu of strictly conventional methods.

5.3.1. Urban Environment and Hydrology

Two of the most important site characteristics that will determine the type and nature of stormwater BMPs that can be successfully used at any site are the soil types and the seasonal high-water table (SHWT) conditions. This is especially true for dry retention BMPs which have the greatest potential to reduce stormwater volumes and pollutant loadings and wet detention BMP’s, which provide a permanent pool volume at the SHWT elevation to reduce pollutant loading.

The USDA Natural Resources Conservation Service (NRCS) provides a regularly updated Web Soil Survey (WSS) at the website listed below. This website provides useful information about the soil types in Pinellas County and their properties including data on the elevation of the seasonal high-water table.

- NRCS Web Soil Survey (WSS) - <https://websoilsurvey.sc.egov.usda.gov/App/HomePage.htm>

The NRCS classifies soils into Hydrologic Soils Groups (HSG). The HSGs classify soils according to their runoff potential. The soil properties that influence this potential are those that affect the minimum rate of water infiltration on bare soil during periods after prolonged wetting. These properties are depth to a seasonal high-water table, the infiltration rate and permeability after prolonged wetting, and depth to a minimally permeable layer. Table 5.3.1 below summarizes the characteristics of the HSG classifications.

Table 5.3.1. Characteristics of NRCS Hydrologic Soil Groups Classifications

<i>SOIL GROUP</i>	<i>DESCRIPTION</i>	<i>RUNOFF POTENTIAL</i>	<i>INFILTRATION RATE</i>
A	Deep sandy soils	Very low	High
B	Shallow sandy soils over low permeability layer	Low	Low
C	Sandy soil with high clay or mineral content	Medium to high	Low

D	Clayey soils	Very high	Low to none
B/D	Shallow sandy soils in high groundwater table area	High – undeveloped (un-drained) Low - developed (drained)	Moderate, restricted by water table in undeveloped conditions
W	Wetland or hydric soils	NA	NA

Given that Pinellas County has been almost entirely developed, the majority of natural soils have been altered from their natural state. Additionally, large areas of the county have been developed on “fill soils”. Furthermore, ditching and drainage have led to modifications of the historic seasonal high-water table conditions. As a result, the collection of site-specific data on soil types and seasonal high-water table conditions is essential to the successful selection, design, construction, and operation of stormwater BMPs.

5.3.2. Pinellas County Watersheds and Receiving Waters

A watershed is an area of land that drains to a receiving body of water. For example, in typical development, stormwater runoff from lawns and driveways travels down the street along the gutter to a storm drain and then runs through underground pipes to a neighborhood pond or stream. From there it drains to Allen’s Creek, Brooker Creek, Lake Tarpon, Lake Seminole, Cross Bayou, and other water bodies in the County. Eventually, it washes into the open waters of Tampa Bay and the Gulf of Mexico. As stormwater drains to water bodies, it carries fertilizers, pet waste, trash, motor oil, and other substances.

Pinellas County has 56 designated [watersheds](#) (Figure 5.3.2). Pinellas County, in cooperation with the [Southwest Florida Water Management District \(SWFWMD\)](#), [Florida Department of Environmental Protection \(FDEP\)](#), and other entities, conducts monitoring of these water bodies to determine their health. As part of the state’s Rotating Basin Cycle, the [FDEP](#) conducts assessments of water body health on a five-year schedule. The product of this assessment is a list of all water bodies within a basin and their current health status. Information about these assessments is available online at:

- DEP Watershed Assessment - <https://floridadep.gov/dear/watershed-assessment-section>
- Pinellas County Water Atlas - <http://www.pinellas.wateratlas.usf.edu/>

As part of the state’s water body assessment process, a list is produced of water bodies that do not meet the state’s water quality standards. This is called the Verified List of Impaired Surface Waters. These impaired waters undergo a long-term planning and implementation process to reduce pollutant loadings discharged into them and to restore their beneficial uses and health. This process includes the development and adoption of Total Maximum Daily Loads (TMDLs). TMDLs establish the maximum pollutant loading capacity for a water body to be healthy and the pollutant load reductions required in that watershed to meet the TMDL and restore the water body to state standards. In many cases, a TMDL implementation plan is developed by the local stakeholders or a Basin Management Action Plan (BMAP) is prepared by [FDEP](#) and watershed stakeholders. Both Plans create a blueprint for reducing pollutant loads and restoring the water body’s health. A table listing Pinellas Receiving Water bodies, including whether a water body is impaired, is available in [Appendix E](#). It is current as of February 2020. For more recent information, please see the web sites below.

- The adopted Verified Lists of Impaired Waters are available online at: <https://floridadep.gov/dear/watershed-assessment-section/content/assessment-lists>
- Adopted TMDLs are listed in Chapter 62-304, F.A.C. and are available online at: <https://www.flrules.org/gateway/ChapterHome.asp?Chapter=62-304>
- The adopted TMDL documents are on-line at: http://www.dep.state.fl.us/water/tmdl/final_tmdl.html
- EPA approved TMDLs are on-line at: <https://archive.epa.gov/pesticides/region4/water/tmdl/web/html/index-2.html>

Pinellas County Watershed Boundaries

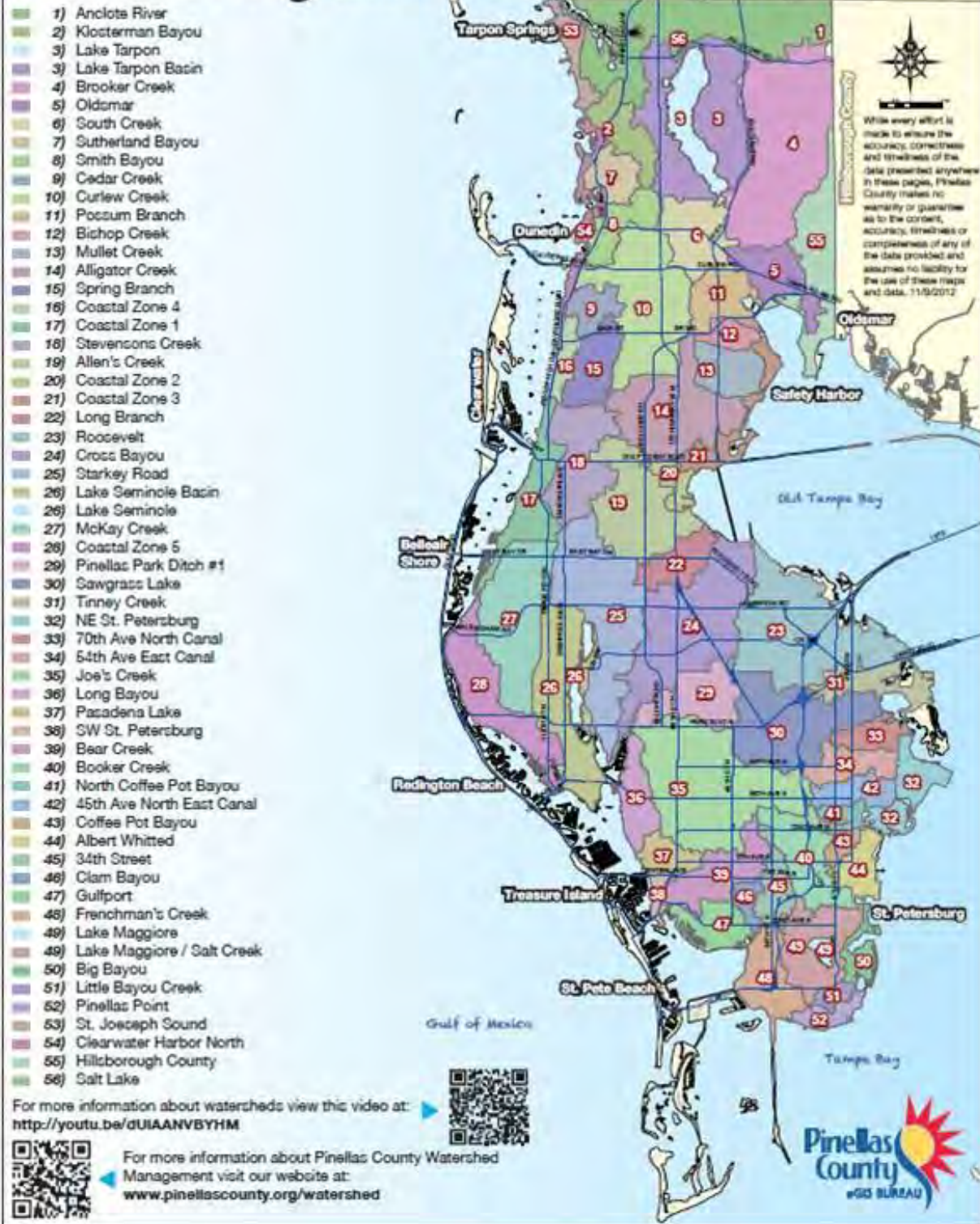

Figure 5.3.2. Pinellas County Watersheds

5.3.3. Discharges to Pinellas County Waterbodies

Pinellas County has adopted by reference the State of Florida's Water Quality Standards that are adopted in [Chapter 62-302, Florida Administrative Code](#). Under Florida law (Chapters [373](#) and [403](#), Florida Statutes), most discharges to Florida water bodies are not allowed without a permit. To obtain a permit under Florida Law, one must demonstrate that the discharge will not cause or contribute to violations of water quality standards in the receiving water body. If a water body fails to meet water quality standards under existing conditions, including any water body on the Verified List of Impaired Waters, no additional discharges of the pollutant causing the water body impairment are allowed. However, Section [373.414\(1\)\(b\)3, F.S.](#), allows one to obtain a permit to discharge to an impaired water body if one can demonstrate "net improvement." This means that the pollutant loading in the new discharge must be less than is currently being discharged from the site.

Because of the number of impaired water bodies in Pinellas County, many future redevelopment projects would be required under state law to meet the "net improvement" treatment standard for their stormwater discharges. This Stormwater Manual has been developed to expand the stormwater BMP options available (see the tool box in [table 6.5.1](#)) to allow redevelopment projects to proceed while meeting the stormwater treatment requirements. To simplify the permitting process, Pinellas County has adopted performance standards for nitrogen and phosphorus in stormwater discharges, as described in Part A- Regulations, Section [3.1.1](#), that meet the "net improvement" requirement under Florida Law.

5.3.4. Flood Control Considerations

Because of its location on the Gulf coast, certain areas in Pinellas County discharge to open tidal systems. These areas generally have fewer stormwater management requirements related to flood control (See [Chapter 2](#)). Accordingly, surface water management systems in these areas can be designed primarily for stormwater treatment. In areas discharging to waters that are not open tidal systems; however, full flood protection requirements (including Compensating Storage below the non-tidal Base Flood Elevation (BFE)) must be met unless it is demonstrated that there is net reduction in flood risk and no adverse impacts. The use of green infrastructure BMPs in these areas will help to reduce stormwater volume, thus providing both water quality and flood control benefits (Subject to [LDC Section 158](#)).

5.3.5. Rainfall Information

In Pinellas County, the amount and distribution of rainfall fit the pattern associated with west coast Florida areas. A majority of storm events have a volume of less than one inch. The average annual rainfall volume is about 51 inches.

Chapter 6 – Evaluating and Master Planning a Site

6.1. Overview

This chapter provides a brief overview of the changes in stormwater characteristics that accompany the urbanization process, the goals of stormwater management, and a discussion of essential site planning requirements. Particular emphasis is placed on water quality treatment best management practices (BMPs) and low impact development.

6.2. Impacts of Development on Runoff

The effects of urban development, resulting from the physical alteration of the natural landscape and the secondary effects of changes in land use can cause many adverse impacts to general land conditions, watershed hydrology, water quality and natural systems, such as freshwater wetlands and floodplains.

Development and redevelopment activities compact soils and add impervious surfaces such as roads, parking areas, sidewalks, and rooftops. These changes reduce, disrupt, or eliminate native vegetation, upper soil layers, shallow depressions, and natural drainage patterns that intercept, evaporate, store, slowly convey, and infiltrate stormwater. As urbanization occurs, the areas that contribute stormwater to receiving waters increase while the areas that naturally manage stormwater diminish. The hydrologic and hydraulic effects of these activities include reduced infiltration and groundwater recharge, increased speed and volume of stormwater runoff and increased erosion and sedimentation. These common consequences of urban development lead to lowering of groundwater tables, altered stream flows; altered wetland and lake water levels; and an increased magnitude and frequency of flooding.

Water quality degradation resulting from urban development accelerates eutrophication in surface waters receiving runoff. The reduction in pervious surface and vegetation in the developed landscape removes natural filtration mechanisms and increases pollutant loads discharged into receiving waters. Fertilizers, pesticides, oils and greases, and other pollutants characteristic of the land uses associated with urbanization further degrade water quality. The following figures summarize the changes in hydrology associated with the urbanization process:

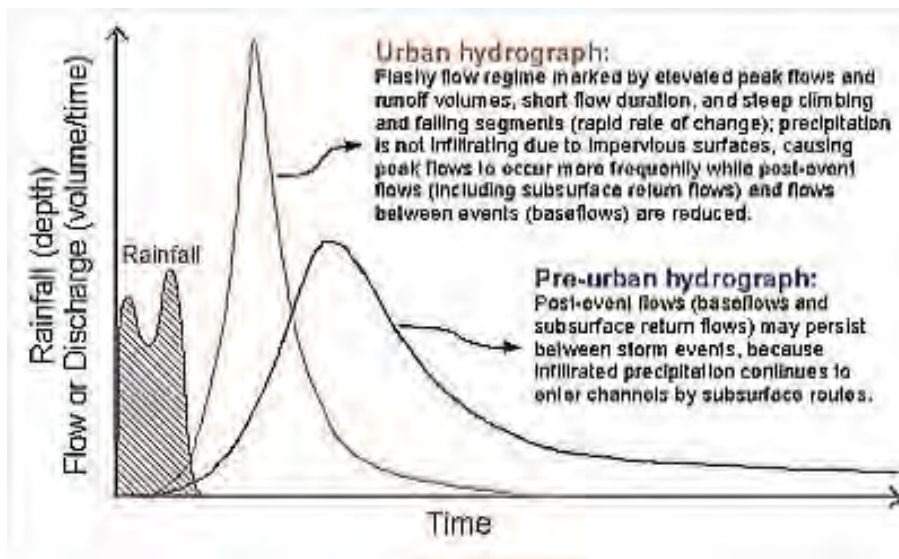

Figure 6.2.1 Stormwater flow changes associated with urbanization. The blue line represents the predevelopment hydrograph and the brown line is the post-development hydrograph. (Source: U.S. Environmental Protection Agency).

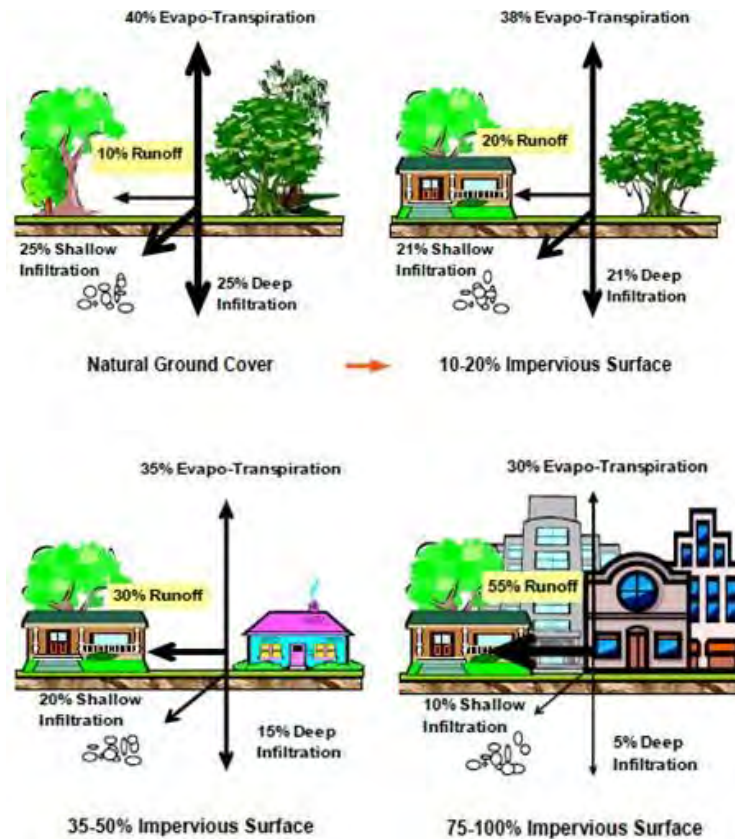

Figure 6.2.2. How Impervious Cover Affects the Water Cycle (Source: U.S. Environmental Protection Agency).

6.3. Goals of Stormwater Management

(a) General goals of stormwater management

The ultimate stormwater management goal is to maintain the predevelopment stormwater characteristics of a site or watershed after development (Section [62-40.431\(2\), F.A.C.](#)). More generally, the goals of stormwater management are to minimize the adverse effects of urban development on communities, watersheds, water bodies, wetlands, floodplains and other natural systems while also accounting for future conditions. These goals should be applied to redevelopment situations so that existing stormwater conditions are appropriately improved with reconstruction. More specifically, these goals include:

1. Reducing pollutant concentrations and loadings to a level to ensure that discharges do not cause or contribute to violations of State water quality standards.
2. Preventing or reducing on-site and offsite flooding.
3. Maintaining or restoring the hydrologic integrity of wetlands and aquatic habitats.
4. Maintaining and promoting groundwater recharge.
5. Promoting the reuse of rainfall and stormwater.
6. Minimizing erosion and sedimentation.
7. Accounting for impacts to the project based on sea level rise projections and future changes in climate.

The goals listed above can best be achieved by mimicking pre-development conditions and managing stormwater at or near its source to the maximum extent practicable. This is accomplished through the use of distributed stormwater BMPs such as green infrastructure (see section 6.5).

(b) Pinellas County Comprehensive Plan - Stormwater Management Goals

The Pinellas County Comprehensive Plan touches on almost every facet of our quality of life - it addresses things like delivery of public services, mobility, the environment and culture, and a myriad of other issues that matter to Pinellas County's citizens, visitors and businesses. Its goals are long-range and are essentially a community vision; the objectives and policies in the Comprehensive Plan direct and prioritize the actions that are necessary to make progress towards, and achieve, the goals. The applicable Policies, Goals and Objectives of the [Comprehensive Plan](#) were used as the foundation for the Stormwater Manual.

The [Natural Resources Conservation and Management Element of the Comprehensive Plan](#) focuses on planning initiatives to protect and enhance the County's natural landscapes, ecosystems, wetlands, ecological greenway systems, floodplains, flood ways and groundwater recharge areas. Objectives and Policies in this section stress the need to preserve and restore natural drainage features during site plan review and the protection of natural recharge areas for water supply purposes. Green infrastructure, low impact development, green building, and other sustainable development techniques are specifically recognized as tools to achieve these goals. Innovative techniques and public education are encouraged.

The [Surface Water Management Element of the Comprehensive Plan](#) addresses the County's broad approach to watershed planning and surface water management and states the County's intent to manage stormwater flow in the urban environment to help reduce the impact on natural features. A goal for future watershed planning is to offset existing stormwater deficiencies in the County. "Natural" design alternatives for stormwater treatment are encouraged.

The [Surface Water Management Element of the Comprehensive Plan](#) also provides a historical perspective on surface water management in Pinellas County. Since most of the County was developed before 1982 when Florida's Stormwater Treatment rules were implemented, the stormwater management focus was on drainage and prevention of flooding. Since 1982, new development and redevelopment projects have been required to incorporate stormwater treatment BMPs into their sites. Traditional stormwater BMPs have only been partially successful in mitigating past and present stormwater impacts, however, and will likely be insufficient without additional tools to help meet the county's stormwater management and natural resource goals.

The [Economic Element of the Comprehensive Plan](#) recognizes the importance of an aggressive economic redevelopment program and encourages a program that enhances design flexibility to promote the local economy and targeted industries. Traditional stormwater treatment BMPs can be land intensive and present challenges to optimal site design, particularly for redevelopment projects. Green infrastructure offers an opportunity for designers to incorporate more effective stormwater treatment methods while achieving greater efficiency in space utilization and optimizing the economic benefits of the development.

6.4. Introduction to Stormwater Management

Stormwater management systems are required to mitigate the stormwater quantity and quality changes that accompany urban development. Stormwater treatment systems are those components of a stormwater water management system constructed to control pollutant loads. Stormwater treatment systems utilize best management practices (BMPs) that can be categorized into two basic categories:

- (a) **Nonstructural BMPs (a.k.a. source controls).** These BMPs are used to minimize pollutants getting into stormwater or to minimize stormwater volume. They include Site Planning BMPs such as preserving vegetation, clustering development, minimizing total impervious and directly connected impervious area. They also include Source Control BMPs such as minimizing clearing of land, minimizing soil compaction, using [Florida-Friendly Landscaping™](#) and minimizing fertilizer use. All of these nonstructural BMPs are part of the green infrastructure principles and practices that are discussed in Section 6.5.
- (b) **Structural BMPs.** Structural BMPs are used to mitigate the changes in stormwater characteristics associated with land development and urbanization. There are three major types of structural BMPs:

retention BMPs, detention BMPs, and filtration BMPs.

- Retention BMPs are infiltration-based practices – the stormwater treatment volume is not discharged directly to surface waters but is “retained onsite” through percolation into the soil, evaporation, and evapotranspiration. Infiltration BMPs include retention basins, exfiltration trenches, swales, vegetated natural buffers, and pervious pavements,
- Detention BMPs are those that detain stormwater and then discharge it offsite at a specified rate, usually the predevelopment peak discharge rate. The most common type of detention BMP in Florida is a wet detention system that has a permanent pool of water.
- Filtration BMPs are detention systems that have discharge structures that incorporate pollutant removal media within a filtration system. Filtration systems are more maintenance-intensive and are generally used only in special circumstances where more traditional retention and detention BMPs do not achieve the stormwater treatment goals for a site or project.
- Table 6.1 lists the nonstructural and structural BMPs incorporated into this Manual. Each of these BMPs is discussed and described in more detail in Section 6.7 (Site Planning BMPs), Section 6.8 (Source Control BMPs), or Chapter 4 (Structural BMPs).

6.5. Introduction to Green Infrastructure Best Management Practices

The utilization of Green infrastructure BMPs is a stormwater management strategy that strives to mimic the pre-disturbance hydrologic processes of infiltration, filtration, storage, evaporation, and transpiration. This is accomplished by emphasizing the use of conservation, on-site natural features, site planning, and distributed stormwater management practices that are integrated into a project's design, especially its landscaping and open space. This decentralized approach to stormwater management not only addresses water quantity and quality requirements in a more efficient manner, but also takes up less developable space, provides aesthetic enhancement, preserves/creates wildlife habitat, reduces energy costs, and filters air pollutants. By embracing sustainable development techniques and employing the use of green infrastructure, many benefits can be realized which result in economic gains. For more information about the many benefits using green infrastructure can have on your project, please see Part B-BMP Criteria.

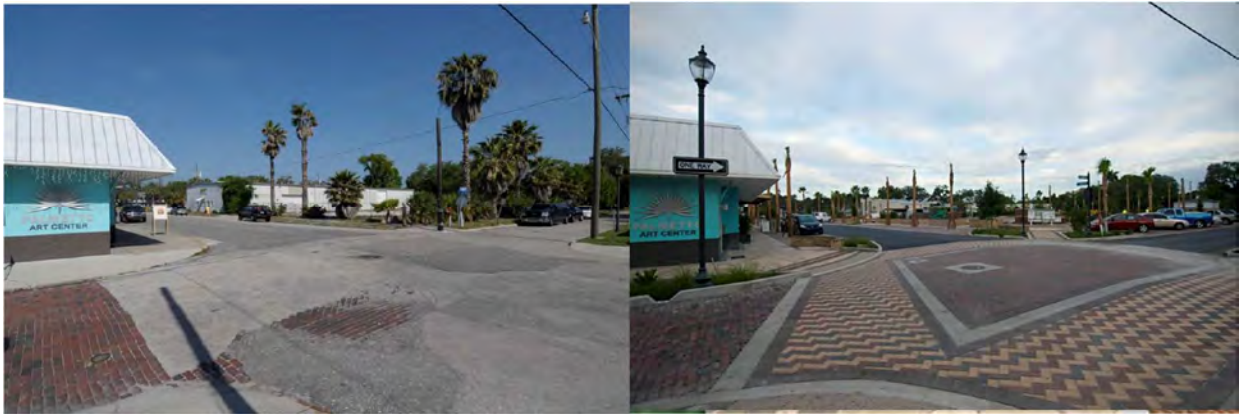

Figure 6.5.1: Where would you rather shop/dine? (5th Street in Palmetto, FL before and after revitalization using green infrastructure – Applied Sciences, Inc.)



Figure 6.5.2: Which would you rather have in your neighborhood? (City of Denver; Conor Park in Palmetto, FL)

Table 6.5.1. Stormwater BMP Tool Box.

Manual Sections	Conceptual Site Planning	Site Planning BMPs	Explicit Load Reduction Credit
6.7.1.	Inventory Site Assets: Hydrology	SP1	
6.7.2.	Inventory Site Assets: Topography	SP2	
6.7.3.	Inventory Site Assets: Soils	SP3	
6.7.4.	Inventory Site Assets: Vegetation	SP4	
6.7.5.	Preserve Open Space	SP5	
6.7.6.	Natural Area Conservation - Retain Tree Canopy and Natural Landscapes	SP6	√
6.7.7.	Cluster Design	SP7	
6.7.8.	Fill Material	SP8	
6.7.9.	Minimize Building Footprint	SP9	
6.7.10.	Minimize Total Impervious Surface Area	SP10	√
6.7.11.	Minimize Directly-Connected Impervious Area	SP11	√
6.7.12.	Curb Elimination and Curb Cuts	SP12	
Manual Sections	Source Control Techniques	Source Control BMPs	Explicit Load Reduction Credit
6.8.1.	Protect Surface Waters and Wetlands	SC1	
6.8.2.	Use Selective Site Clearing and Grading	SC2	
6.8.3.	Retain Natural Landscape Depressions	SC3	
6.8.4.	Minimize Soil Disturbance and Compaction	SC4	
6.8.5.	Build with Landscape Slope	SC5	
6.8.6.	Retain Native Landscapes at the Lot Level	SC6	
6.8.7.	Florida-Friendly Landscapes™ and Fertilizer Management	SC7	√
6.8.8.	Install Efficient Irrigation Systems	SC8	
6.8.9.	Use Non-potable Water Supply for Irrigation	SC9	
6.8.10.	Community and Home Owner Education	SC10	

Manual Sections	Structural Stormwater BMPs	Structural BMPs	Explicit Load Reduction Credit
4.1	Retention Basin Design Criteria	SW1	√
4.2	Exfiltration Trench Design Criteria	SW2	√
4.3	Underground Storage and Retention Systems Design Criteria	SW3	√
4.4	Bioswales/Treatment Swales/Green Gutters	SW4	√
4.5	Vegetate Natural Buffers	SW5	√
4.6	Pervious Pavements Systems	SW6	√
4.7	Green roofs with Cisterns Systems	SW7	√
4.8	Wet Detention Systems	SW8	√
4.9	Stormwater Harvesting/ Horizontal Wells	SW9	√
4.10	Up-Flow Filter Systems	SW10	√
4.11	Managed Aquatic Plant Systems (MAPS)	SW11	√
4.12	Biofiltration Systems/Tree Box Filters	SW12	√
4.13	Rain Gardens	SW13	√
4.14	Rainwater Harvesting/Cisterns	SW14	√
4.15	Rainfall Interceptor Trees	SW15	√
4.15	Rainfall Interceptor Trees	SW16	√

Unlike conventional stormwater systems, which typically control and treat runoff using a single engineered stormwater BMP located at the “bottom of the hill,” green infrastructure is designed to promote volume attenuation and treatment at or near the source. These green infrastructure systems use a suite of stormwater BMPs – Site Planning BMPs, Source Control BMPs, and Structural BMPs such as retention, detention, infiltration, treatment, and harvesting mechanisms – that are integrated into a project site to function as a “BMP Treatment Train.”

The toolbox of green infrastructure integrated management practices, including structural and non-structural designs, is most effective when applied in a BMP treatment train, or series of complementary stormwater management practices and techniques. Typically, green infrastructure design practices will not completely replace more conventional “bottom-of-the-hill” stormwater management practices but can be used to complement these practices and to ensure that the entire stormwater management system meets the Pinellas County water resources objectives. Combining conventional and green infrastructure management practices can reduce the area devoted solely to stormwater management and allow more efficient use of the development site.

To effectively use and integrate green infrastructure practices into a stormwater management system requires sites to be evaluated for compatibility as early as possible in the planning process. Specific site conditions must be carefully evaluated to determine the feasibility and to design and construct each green infrastructure element. This manual supports Pinellas County's goal of applying the green infrastructure concept and design where feasible to enhance existing stormwater management measures and reduce the adverse impacts of land development projects on the County's natural resources.

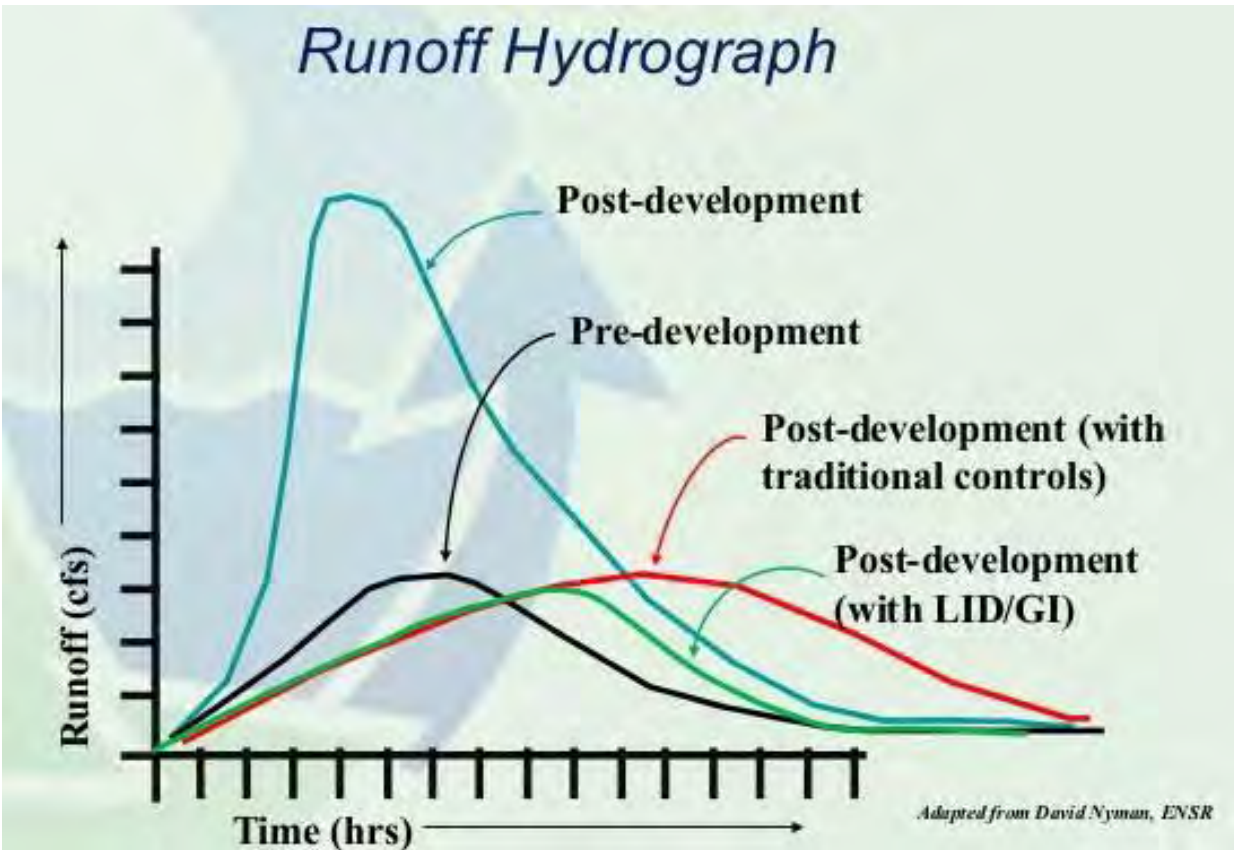

Figure 2.5.3. Hydrograph of LID stormwater infrastructure compared to traditional infrastructure management approaches. LID restores hydrograph behavior to better resemble pre-development flow patterns (Source: Horsley Witten Group, Inc.).

The BMPs described in this manual, in combination with other elements of a surface water management system, may incorporate methods to collect, convey, store, absorb, inhibit, treat, use or reuse stormwater to prevent or reduce flooding, over drainage, environmental degradation, and pollution, or otherwise affect the quality and quantity of stormwater discharges. Although this manual has a significant focus on stormwater treatment, County and State requirements related to flood control will also apply as set forth in Chapter 2.

This manual combines conventional stormwater BMPs and green infrastructure BMPs with the intent of allowing sufficient flexibility for the optimization of site utilization while meeting the County's performance objectives for stormwater management and treatment. Other methods of meeting the overall water resources objectives of the County will be considered. For all projects, it is advisable to check with local officials and other agencies to determine applicable project-specific criteria.

a) Goals of Green Infrastructure

To improve upon conventional stormwater management and better meet the goals of the Comprehensive Plan, Pinellas County promotes the implementation of green infrastructure principles and practices, which aim to mimic natural processes. Incorporating green infrastructure into the development process entails the application of the following principles in the design, construction, and operation of the stormwater management system:

1. **Achieve multiple objectives** – Comprehensive stormwater management helps achieve multiple objectives such as managing peak discharge rates and total discharge volume; providing effective stormwater treatment to minimize pollutant loadings; maintaining or improving the hydrologic regime at a site; and retaining or harvesting stormwater onsite for non-potable purposes.
2. **Preserve or restore natural features and resources** – The conservation or restoration of natural features such as floodplains, soils, and vegetation helps to retain or restore hydrologic functions thereby achieving the multiple objectives above.
3. **Minimize soil compaction** – Soil compaction disturbs native soil structure, reduces infiltration rates, and limits root growth and plant survival.
4. **Reduce and disconnect impervious surfaces** – By minimizing impervious surfaces, especially directly connected impervious surfaces, more rainfall can infiltrate into the ground.
5. **Manage stormwater close to the source** - Using source controls to minimize the generation of stormwater or pollutants that can get into stormwater needs to be the first step in managing stormwater.
6. **Use a BMP Treatment Train approach** – Effective stormwater management requires a comprehensive approach that incorporates source controls with multiple structural stormwater BMPs (retention, detention, and filtration) often integrated into the landscaping to create an efficient stormwater management system.

b) Green Infrastructure Site Design Objectives

Green infrastructure facilitates on-site infiltration by applying practices that preserve pervious surfaces, limit the total area of impervious surfaces, and disconnect impervious surfaces. The following site design objectives are key to achieving the County's stormwater hydrology and pollutant load reduction goals:

1. **Conservation Measures** - Preserve or conserve existing site features and assets that facilitate natural hydrologic function.
 - Maximize retention and protection of native forest cover, vegetation, and wetlands and replant trees and other vegetation to intercept, evaporate, and transpire precipitation.
 - Preserve permeable, native soil, and enhance disturbed soils to store and infiltrate stormwater.
 - Retain and incorporate topographic site features that slow, store, and infiltrate stormwater.
 - Retain and incorporate natural stormwater management features and patterns.
 - Minimize site disturbance and compaction of soils through low impact clearing, grading, and construction measures.
2. **Site Planning and Minimization Techniques** - Minimize generation of runoff and pollutants from your project as close to the source as possible
 - Use a multidisciplinary approach that includes planners, engineers, landscape architects, and architects at the initial phases of the project.
 - Locate buildings away from critical areas and soils that provide effective infiltration.
 - Reduce hard surfaces, total impervious surface area, minimize directly connected impervious areas, increase retention of native vegetation, and plant native trees.
3. **Distributed and Integrated Management Practices**
 - Manage stormwater as close to its origin as possible by using small scale, distributed hydrologic controls.
 - Create a hydrologically rough landscape that slows storm flows.
 - Increase reliability of the stormwater management system by providing multiple or redundant green

infrastructure flow control practices.

- Integrate stormwater controls into the development design and use the controls as amenities to create a multifunctional landscape.
 - Reduce the reliance on traditional conveyance and pond technologies.
4. **Low Impact Construction Techniques** - Clearing, grading, and construction measures that minimize site disturbance and promote green infrastructure function include:
- Minimizing the amount of area cleared.
 - Clearing selectively to protect trees and other vegetation.
 - Using smaller and lighter construction equipment where possible.
 - Keeping heavy equipment outside of the drip line of preserved trees.
 - Minimizing grading and importing of fill (e.g., through use of stemwall construction).
 - Keeping heavy equipment off soils where infiltration-dependent stormwater practices will be used.
 - Designating storage areas for construction equipment and materials

Stormwater Control Measure	Construction Timing
Tree Canopy Retention and Drip Line Root Protection	Very Early
Neighborhood Design	Very Early
Vegetated Natural Buffers (VNB)	Early
Minimization of Site Disturbance and/or Construction Footprint	Early
Reducing Directly Connected Impervious Areas (DCIA)	Early
Grassed or Vegetated Swales on Uncompacted Soil (Includes Curb Cuts)	Early – Middle
Permeable Pavements	Middle
Dry Wells or Exfiltration Tanks	Middle
Green Roofs	Middle
Bioretention or Rain Garden	Middle – Late
Tree Boxes and Tree Filters	Middle – Late
Cisterns and Rain Barrels	Middle – Late
Stormwater Reuse Ponds	Middle – Late
Soil Amendments	Late
Florida-Friendly Native landscaping	Late
Drip Irrigation	Late

Figure 6.5.4: Construction timing for various BMPs – Dr. Eban Bean, UF IFAS Extension

5. **Maintenance and Education**

- Develop reliable and long-term maintenance programs to provide clear and enforceable standards.
- Educate owners of green infrastructure projects, landscape management professionals, and other interested parties on the operation and maintenance of green infrastructure systems.
- Protect green infrastructure systems by promoting community participation.
- Maintenance will be different than traditional “gray” BMPs, but ultimately will prove to be less intensive, involved, and costly – a large, deep pond devoid of vegetation is bound to have problems operating as required/permitted, and it is very expensive to maintain and repair. Employing smaller, distributed green infrastructure BMPs will end up being easier and cheaper to maintain over the long term.

6.6. Site Planning and Design with Green Infrastructure

The Importance of Green Infrastructure in Coastal Communities

The United States Clean Water Act designates many coastal water bodies to be available for swimming and shell-fishing, through the establishment of legal obligations to protect and restore “existing” uses of coastal waters. [Conventional stormwater measures jeopardize the quality of coastal waters](#) due to their inability to adequately treat and remove materials in stormwater runoff that can compromise human and environmental health. The coupling of inadequate, conventional stormwater infrastructure with the high population density of the County has resulted in significant stormwater pollution causing impairments to nearly all of the County’s waterbodies. LID that focuses on the implementation of GI for managing stormwater has been shown to have the potential to protect and restore coastal water quality as long as it successfully replicates natural hydrology. GI should become the cornerstone of watershed management strategies for coastal areas and should accompany Total Maximum Daily Load implementation plans.

In addition to safeguarding the quality of Pinellas County’s coastal water, GI facilitates recharging of the groundwater by enhancing infiltration. This is of particular importance to Pinellas County where the vast majority of drinking water is sourced from groundwater from the Floridian Aquifer that relies on rainfall for replenishment. The County has been able to meet water demand despite growing populations through effective water conservation, which has ultimately lowered the demand for [potable water](#). However, variations in weather and rainfall patterns and the looming threat of drought are all causes for concern, highlighting the importance of prioritizing the County’s water resources. Sea-level rise (SLR) presents another looming threat that will exacerbate saltwater intrusion into the groundwater supply, fostering implications of increased costs for potable water. Widespread implementation of GI can help to counteract the effects of saltwater intrusion by [replenishing the groundwater](#) that actively “pushes back” the intrusion of saltwater.

Preserving or enhancing the hydrologic signature of a site to promote management of stormwater volumes and pollutants **at the source**, integrated with a **series of on-site treatment practices**, increases the effectiveness of a stormwater management system. This is typically referred to as a “treatment train” approach to stormwater management. Project planners and engineers are encouraged to evaluate and design sites with a holistic perspective and in a fashion that is consistent with the treatment-train approach.

While potential stormwater infiltration capacity and rates are constrained by predevelopment conditions such as Seasonal High Groundwater Table (SHGWT), soil types, and soil compaction, infiltration-dependent green infrastructure practices can be designed to perform effectively as part of a treatment train under most site conditions in Pinellas County. Optimal areas for locating infiltration-dependent stormwater practices (i.e., those with the highest infiltration rates) should be identified during the site-assessment phase of development.

Project planners and design engineers should consider stormwater an asset that can be used to reduce the impact of development projects on water resources. Rather than designing systems to drain stormwater from the site, green infrastructure promotes retention, treatment and harvesting of stormwater onsite. To encourage the practice of using stormwater as an asset, Pinellas County has included incentives within its Land Development Code that allow open space requirements to be satisfied through green infrastructure stormwater management techniques. Please refer to [Chapter 138, Zoning, of the Land Development Code](#).

Stormwater is a valuable freshwater resource that can be captured and used for a variety of non-potable purposes. Cisterns or rain barrels can be used for collecting, storing, and using rainwater for irrigating lawns and landscape beds, irrigating green roofs, washing vehicles, and toilet flushing as approved by state and Pinellas County health codes. Detention systems can incorporate “stormwater harvesting” to reduce stormwater volume and pollutant loading discharges and save valuable freshwater for landscape irrigation or other non-potable purposes.

Mechanisms to reduce site disturbance before, during, and after construction are some of the most critical elements of an integrated and effective approach to green infrastructure stormwater planning. Opportunities to preserve and promote natural hydrologic functioning of a site are often lost as a result of conventional development practices such as non-selective site clearing, export of native soils, importing of fill, mass

grading, and construction in sensitive areas using heavy machinery. Compacting soils reduces the pore space available for storage and infiltration of stormwater.

To effectively use and integrate green infrastructure practices into a stormwater management system requires sites to be evaluated for green infrastructure compatibility as early as possible in the planning process. Specific site conditions must be carefully evaluated to determine feasibility and to design and construct each green infrastructure practice. This manual supports Pinellas County's goal of applying the green infrastructure concept and design where feasible to enhance existing stormwater management measures and reduce the adverse impacts of land development and redevelopment projects on the County's natural resources.

Assessing a site's natural stormwater management capabilities and resources is a necessary step toward integrating them into the stormwater management system. The site assessment process provides information about current conditions that are essential to implement the site planning and layout activities. Specifically, site assessment should evaluate hydrology, topography, soils, vegetation, wetlands, and water features to identify how stormwater moves through the site before and after development or redevelopment. Projects should be designed and constructed with the objective of preserving and using on-site features to help manage stormwater. Site conditions that need to be evaluated include:

- What natural features (tree canopy, vegetation, depressions, etc.) intercept or capture rain as it falls on the site and return portions of it to the atmosphere via infiltration, evaporation or transpiration?
- What is the topography of the site and does it promote stormwater drainage away from the site or capture and infiltrate stormwater on site?
- Is the site adjacent to a water body or wetlands and does it have any buffer or riparian zones?
- What are the hydrologic soil groups and distributions on-site, and to what extent do they promote infiltration of rainfall (i.e., what are their infiltration rates)? As noted below, many soils in Pinellas County are classified in the B/D hydrologic soil group (moderately well drained when dry, not well-drained when wet) due to a shallow Seasonal High Groundwater Table (SHGWT).
- Where and to what extent have soils been modified, disturbed and/or compacted, reducing infiltration rates and promoting runoff generation?
- What is the elevation of the SHGWT throughout the site and when and how long does it occur?
- Do critical and sensitive areas (wetlands, riparian areas, etc.) that provide capture, uptake, and filtering of pollutants exist on site and have they been protected or disturbed?
- What physical structures (buildings, parking lots, etc.) intercept rainfall and convey it as stormwater to other areas of the site or away from the site?
- What pervious surfaces (natural and structural) allow stormwater to infiltrate to parent soils?
- What impervious surfaces (natural and structural) prevent infiltration of stormwater and promote runoff?
- What engineered stormwater treatment systems exist on site and could they be enhanced or retrofitted to improve performance?

Use the following Site Planning BMPs (Section 6.7) and Source Control BMPs (Section 6.8) to assess your site and begin designing the BMP treatment train.

For assistance with estimating the lifecycle costs of various green infrastructure BMPs, see <https://smartech.gatech.edu/handle/1853/62873>.

6.7. Site Planning Principles

Sustainable Site Planning principles should be applied as part of the development design process to ensure efficient land usage and preservation of the area's natural hydrology. The following twelve (12) sustainable site planning principles should be considered for each project. These site planning principles are associated with Smart Growth practices. Additional information pertaining to sustainable site planning may be found at www.epa.gov/smartgrowth.



Figure 6.7.1. Site Planning responding to existing conditions.

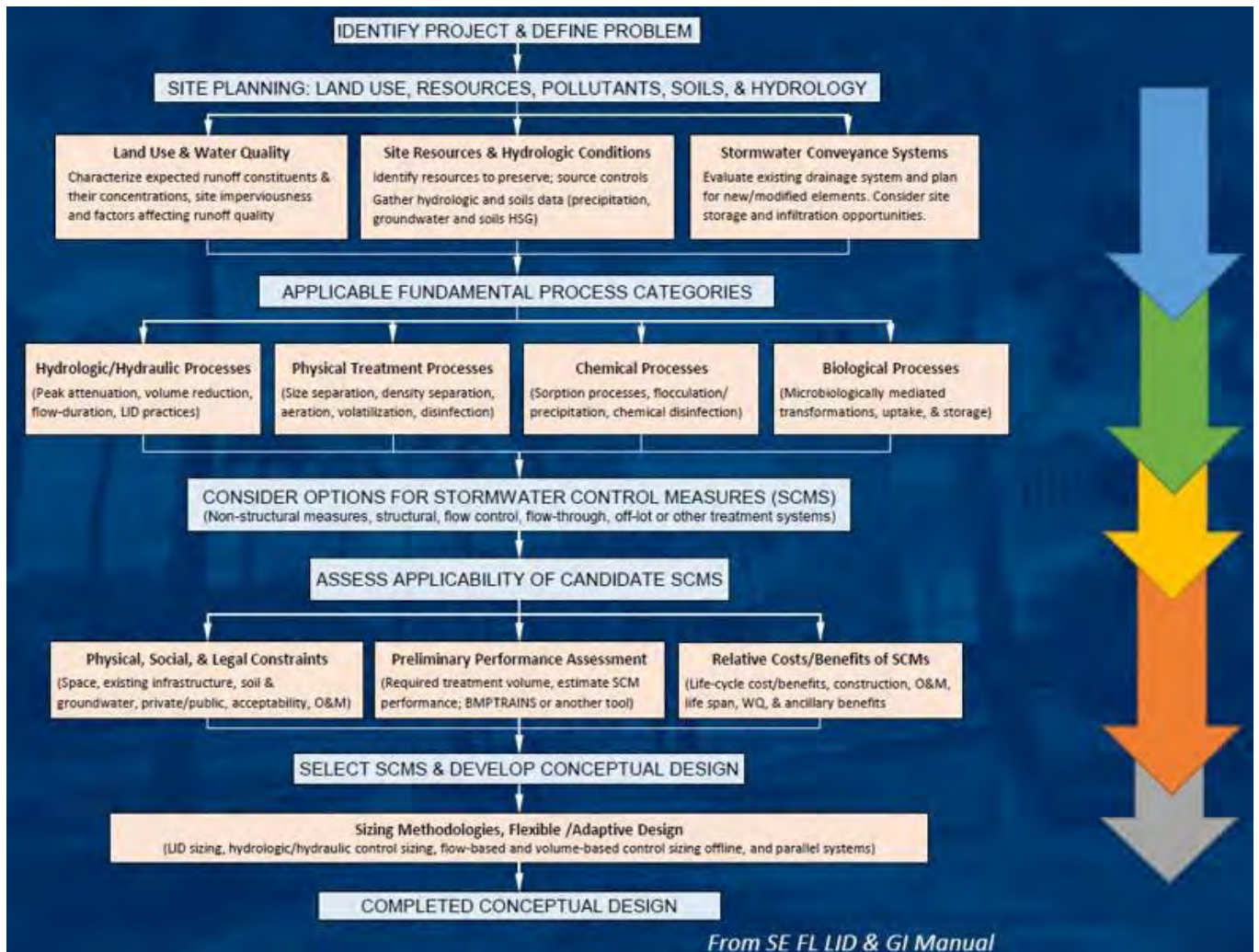

Figure 6.7.2: Conceptual Design Process – graphic from UF IFAS presentation, Dr. Eban Bean

6.7.1. Inventory Site Assets: Hydrology

It's important to identify and retain the predevelopment hydrology to the maximum extent possible, including natural flow/conveyance paths and patterns and drainage features. Maintain or replicate original site hydrology, meaning maintain predevelopment surface runoff, infiltration, and evapotranspiration rates and hydrologic assets of the site to the fullest extent possible. When assessing a site for green infrastructure opportunities, it is important to understand the stormwater sources and sinks in each catchment and sub-catchment, and plan accordingly.

Does runoff leave the site through surface or subsurface drainage? Is there potential for sinkhole formation or stream bank erosion? Although sinkholes form naturally, concentration of flow in small area or increased pressure from storage of large volumes of stormwater can accelerate the process. Both peak flow rate and total volume of runoff can contribute to erosion.

Are there adjacent land uses or sites that will contribute additional stormwater runoff or pollutant loads that will need to be addressed? In this phase of planning, the need for buffer strips or other strategies to protect sensitive areas (water bodies, karst features, desirable wildlife or cultural areas) in or adjacent to your site should also be identified.

6.7.2. Inventory Site Assets: Topography and Watershed Patterns

The predevelopment topography and watershed patterns should drive the stormwater design of a project, rather than the topography and watershed patterns of the site being altered during development to fit a traditional stormwater management plan. Use the topographic/watershed characteristics of the site to guide the road layout and stormwater conveyance features and consider the natural watershed patterns when delineating lots and placing public infrastructure. Topographic/watershed features should also guide lot-level landscape layout and plantings. For instance, avoid re-contouring and installing high-maintenance landscaping or turf, or disturbing areas with steep slopes or natural landscape depressions that should be preserved for their infiltration capacity. Natural depressions should be maintained where possible to promote storage, infiltration, and treatment during typical stormwater events and to capture part of the treatment volume during extreme events.

Consider site vegetation and topography, maintain natural hydrology, and limit compaction of soils as shown in the figures below.

6.7.3. Inventory Site Assets: Soils

Inventory and delineate the extent of all soil types present on site. In many parts of Pinellas County soils have been changed or are a combination of fill dirt often called “urban soils”. Determine their hydrologic group classifications and capacity for stormwater infiltration. Clearly mark on drawings and designate on site all areas that will be vegetated or used in stormwater management to prevent soil compaction and maintain the soil infiltration capacity. Consider any significant differences in infiltration potential when planning and laying out the proposed development. Employ careful site clearing, grading, equipment and materials staging when planning construction to limit compaction and protect native soil characteristics.

6.7.4. Inventory Site Assets: Vegetation

Inventory existing vegetation on the site and conduct a tree survey to identify “specimen trees” and “specimen tree stands”. Protection of trees and native vegetation is intended to promote carbon dioxide absorption, oxygen production, dust filtration, reduction of wind, noise, and glare, soil stabilization and enrichment, erosion prevention, surface drainage improvement and aquifer recharge, water pollution reduction and wildlife habitat. Additional benefits may include energy conservation, temperature moderation, the economic enhancement of improved and vacant lands, scenic beauty, quality of life, and the health, safety, welfare and well-being of the community. Tree BMPs include BMP SP6 – “Natural Area Credit for Specimen Tree Stands”, – in Section 6.7.6., and SW15 – “Rainfall Interceptor Trees”, - in Section 4.15.

6.7.5. Preserve Open Space

Once a thorough inventory of the site assets that facilitate green infrastructure BMPs has been completed, the first planning strategy is to preserve these assets to the maximum extent possible. Consider all areas where open space and pervious areas can be protected. Pinellas County requires open space for specific uses in certain zoning districts; the County also requires landscaping areas for most projects. Green infrastructure stormwater methods may be used for partial credits towards these open space/landscaping requirements. (See [Chapter 138 of the Zoning Code](#).)

Since much of Pinellas County is already developed, not many sites contain significant areas of natural vegetation that can be preserved. However, areas with “specimen tree stands” need special consideration and several established ecological principles should be considered when initially laying out development and setting aside open spaces.

- The main idea is to reduce the length of edges between the development and natural area. Edges have greater disturbance, more predators, and poorer habitat for many species. The width of an

edge varies by species but can extend 150-300 feet into a patch of habitat, equivalent to about an eight-acre circle.

- The shape of natural areas is important for minimizing the effects of development on many plants and animals. Therefore, one 15-acre natural area is much better than five 3-acre natural areas. Similarly, a roughly circular shape has a shorter perimeter than a long narrow or irregularly shaped site with the same area.
- Patches with “soft” edges (gradual & undulating vegetation) are better than those with “hard” edges (straight & sudden)
- It is not always possible to design a natural area with inland areas free of edge effects. However, any open space is better than none, as some species will still benefit despite edge effects.
- Where there are several patches of natural habitat, connecting them with a corridor is desirable. Wide corridors are better than narrow, and natural corridors are better than man-made.
- If both land types exist on site, wet *and* dry areas should be included in a preserved area.
- Preserve rare natural communities over more common ones, using the [Florida Natural Areas Inventory state and global rarity ranking](#).

6.7.6. Natural Area Conservation - Retain Tree Canopy and Natural Landscaping

Tree canopy can be viewed as the first line of defense in stormwater source control. Retaining native and large tree canopies to the maximum extent possible and planning new tree [plantings](#) to maximize tree canopy over the life of the project will help retain and enhance predevelopment interception and evapotranspiration capacity, reducing generation of stormwater runoff.

There is evidence that tree canopies have the potential to intercept approximately 15-20% of the water in a storm event that falls on their leaves. This water is retained by surface tension and reduces the potential for runoff from impervious surfaces directly underneath the canopy. Tree canopies retain rain water on leaves via surface tension (up to 15% of the water that falls on the canopy), a virtual “retention pond in the sky”. Consult Section 4.15 of this Manual for requirements for Interceptor Tree BMP that provide stormwater credits for retaining large native trees on site or for reforesting portions of a site. Tree well technology for soil porosity provides protection underfoot-travel paved areas and allows for regular tree root growth.

Position or plant trees so that when they are fully grown (10-40 yrs., depending on species) they will cover impervious surfaces or shade buildings during the summer months, from noon to late afternoon. Use deciduous trees when and where appropriate to provide shade in the summer months and to maximize solar gain during the winter months. Maximize the amount of tree canopy cover over impervious surfaces to get stormwater credit for using interceptor trees.



Avoid complete site clearing



Retain trees where possible

Natural Area Conservation Load Reduction Credit: Protection of specimen tree stands, or natural areas and their associated vegetation helps maintain the undeveloped hydrology of a site by reducing runoff, promoting infiltration and preventing soil erosion. The undisturbed soils and native vegetation of conservation areas promote rainfall interception and storage, infiltration, runoff filtering and direct uptake of pollutants. Natural areas are eligible for stormwater credit if they remain undisturbed during construction and are protected by a permanent conservation easement prescribing allowable uses and activities on the parcel and preventing future development. Examples of conservation areas include any areas of undisturbed vegetation preserved at the development site, such as forests, floodplains and riparian areas, steep slopes, and stream, wetland and shoreline buffers.



1. **Calculation of Stormwater Treatment Credit** - Specimen tree stands or natural areas that are placed into conservation will be excluded from the runoff calculations used to determine the volume of stormwater that must be treated or to calculate pre- and post-development nutrient loads.
2. **Conditions for Credit** - Proposed conservation areas will meet all of the conditions outlined below to be eligible for credit:
 - The minimum combined area of all specimen tree stands, or natural areas conserved at the site must exceed one-acre.
 - No disturbance may occur in the conservation area during or after construction (i.e., no clearing or grading except for restoration operations or removal of exotic vegetation unless provided for within the conservation easement).
 - The limits of disturbance around each conservation area will be clearly shown on all construction or permit drawings.
 - A long-term vegetation management plan must be prepared to maintain the conservation area in a natural vegetative condition. Managed turf is not considered an acceptable form of vegetation management, and only the passive recreational areas of dedicated parkland are eligible for the credit (e.g., ball fields and golf courses are not eligible).
 - The conservation area must be protected by a perpetual easement that is filed in the public records prior to beginning construction.
 - The credit cannot be granted for natural areas already protected by existing federal, state, local law, or existing conservation easement.

6.7.7 Cluster Design

It is recommended that development activity on a site be consolidated to the level, clear, and upland portions of the property; thus, leaving high quality natural elements undisturbed. Clustering of built infrastructure at the development or subdivision scale is a preferred technique that can significantly reduce the overall environmental impacts of a project. This strategy is useful primarily for residential and mixed-use developments. Cluster design typically reduces the length of roads (and therefore transportation infrastructure costs as well), total impervious area and area needed for stormwater management infrastructure and reduces overall site disturbance. It also allows the opportunity in project design to maintain natural areas and wildlife habitat.

The cluster design approach allows a developer to maximize the allowable density through design flexibility. Through clustering, the maximum allowable units may be provided as smaller lots, attached dwellings, and/or multi-family structures; this allows for open space and other natural assets to remain undisturbed and concentrated as larger systems. By reducing the total project impact, the use of both clustering and smaller lot sizes (in some cases) may allow the developer to increase the total number of developed units or lots, thereby increasing total project revenues.

6.7.8 Fill Material

Design sites to work with existing topography and soils to the greatest extent possible; approach design

solutions that minimize the need to import fill material. Use off-grade construction rather than fill. Fill material in Florida, usually has a significantly different composition from native soils, particularly in the potential for phosphorus (P) leaching. In the example illustrated below, the fill pH was 7.3 vs. 5 in nativesoil, and leachable P was on the order of 50 times as great

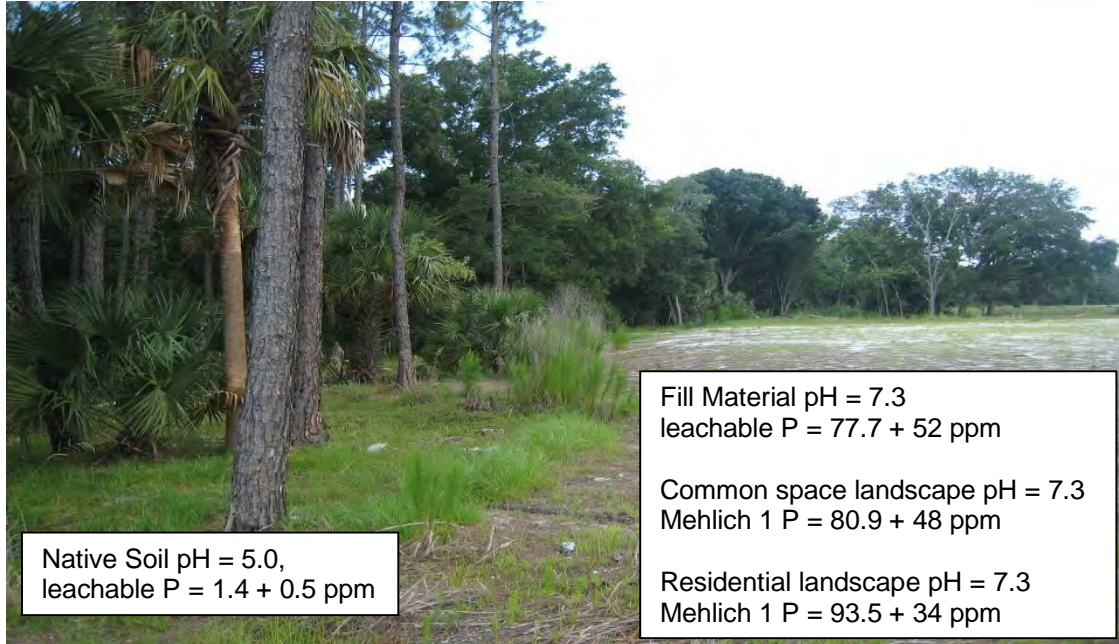

Native vs Fill Material soil composition

6.7.9. Minimize Building Footprint

To reduce the impervious footprint of the project and disturbance of the site, consider multi-story building design options for the project (i.e., build vertically). Buildings with more than one story maximize the square footage to roof area ratio and lessen the stormwater runoff from the site. On sloping sites, rather than importing fill to make a level site for slab-on-grade foundations, use stem-wall construction and minimize the area disturbed and compacted.

6.7.10. Minimize Total Impervious Surface Area

Minimizing total impervious surface area reduces the post-development stormwater volume and peak discharge rate. There are many design options to minimize total impervious surface area, thereby increasing the potential for infiltration of stormwater, particularly with street and parking design.

Street design should look for a layout that reduces the total street length and achieves efficient site access with less paved surfaces. Design projects with narrow street widths. This may also include smaller turnaround features such as “T” and “Y” options as alternatives to cul-de-sacs. When alleyways and auxiliary roads are necessary, use load-bearing pervious pavements or permeable pavers.

Parking lots should be designed to use small parking space dimensions and the fewest number of parking spaces necessary to accommodate the associated use. Pervious pavement can be used for many parking lots, especially for overflow parking (for seasonal or rare events). Maximize infiltration capacity of parking areas by using structurally-reinforced grass areas or pervious gravel areas for overflow parking. Where possible, design impervious areas to first drain into interior recessed rain garden islands with overflow directed via sheet flow across pervious areas to swales or finally a piped conveyance system.

6.7.11. Minimize Directly-Connected Impervious Area (DCIA)

Directly-connected impervious areas allow runoff to be conveyed without interception by permeable areas that allow for infiltration and treatment. Disconnecting impervious areas from roofs, small parking lots, courtyards, driveways, sidewalks and other impervious surfaces allows runoff to flow onto adjacent pervious areas where it is filtered or infiltrated. Reduce DCIAs by designing the site to divert sheet flow into a swale, infiltration basin, rain garden, vegetated natural buffer or pervious area for treatment. Disconnection of rooftops offers an excellent opportunity to harvest this rainwater and either reuse it or distribute it over lawns and other pervious areas where it can be filtered and infiltrated. Downspout disconnection can infiltrate runoff, reduce runoff velocity, and remove pollutants. Alternately, downspouts can be directed to a cistern, rain barrel, dry well, rain garden or landscaped infiltration area (See Rainwater Harvesting BMP).

Use curb cuts or uncurbed roads that will drain to vegetated swales as a method to reduce directly connected impervious areas (See 6.7.12). To the greatest extent possible, drain parking lots to vegetated swales, exfiltration systems, or interior vegetated parking lot islands that have been designed as rain gardens. Incorporate underdrains or elevated culverts to protect against flooding.

At the project level, disconnection of impervious area can reduce the need for costly stormwater conveyance and treatment infrastructure. Instead of gathering all stormwater runoff from parking areas and building roof and piping it to a large, centralized basin, the stormwater should be treated incrementally, close to the source of generation. Gather and treat the stormwater from each roof side into separate, small rain gardens on each side of the building. Again, pervious pavement should be considered for parking or drain runoff to vegetated areas where possible.

As seen in Table 6.10.2, the required stormwater treatment volume is directly related to the amount of DCIA. Disconnecting small areas of impervious cover from the storm drain system can greatly reduce the total volume and rate of stormwater runoff. Credits for surface disconnection are subject to the restrictions below concerning the length, slope, soil characteristics of the pervious area which are designed to prevent any reconnection of runoff with the storm drain system. In some cases, minor grading of the site may be needed to promote overland flow and vegetative filtering.



DCIA Stormwater Treatment Credit - The total disconnected impervious area is removed from the Directly Connected Impervious Area calculations of stormwater treatment volume and included in the non-DCIA calculations when computing the stormwater treatment volume. This will reduce the stormwater volume which then reduces the stormwater pollutant loading.

Conditions for Credit - For the purposes of the stormwater treatment rule, impervious area is disconnected if all the following conditions apply for the overland flow of stormwater:

- The contributing impervious area is not more than 50% larger than the overland flow area.
- Non-directly connected impervious areas include all pervious areas and portions of impervious areas that flow over at least 10 feet of pervious areas with HSG A or B soils and over at least 20 feet of pervious area for other soil types.
- The roof runoff is diverted into a cistern, rain barrel, or other storage device where the water is reused for non-potable purposes (rainwater harvesting).
- The surface slope for overland flow must be between 0.5% and 5.0%.
- The velocity of runoff from a 5-year frequency storm must not exceed 0.15 feet per second.
- The infiltration capacity of soils in the overland flow path must be sufficient and not reduced by compaction, or amendment and tilling will be required to restore permeability.

Soil amendments, as discussed in the Biofiltration Section (Section 4.12), may be needed to restore porosity of compacted pervious areas. Soil amendments refer to tilling, composting, or other amendments to urban soils to recover soil porosity, increase water-holding capacity, and reduce runoff. Soils in many urban areas are highly compacted as a result of prior grading, construction traffic and ongoing soil disturbance. Amendments recover soil porosity by incorporating compost, top soil, and other soil conditioners to improve

the hydrologic properties of lawns or landscaped areas.

6.7.12. Curb Elimination and Curb Cuts

Curbs and gutters are often inconsistent with the goal of maintaining natural hydrology. Curbs concentrate runoff into faster flowing, more erosive streams of water. Simply eliminating curbs and allowing stormwater to drain in sheet flow from roadways onto vegetated areas slows runoff and reduces peak discharge rates. If used in conjunction with downstream infiltration BMPs, total stormwater volume and stormwater pollutant loads are reduced.

Landscape areas and vegetative areas can be effective stormwater management elements. Wheel stops, curbs with cuts and curbs with raised semi-spherical knobs can be used in vehicle use areas without obstructing the flow of stormwater. Pavement must be graded so that stormwater flows through the curb cuts onto the vegetated area. Thus, roadways and other paved areas can be changed from DCIA to non-DCIA areas, reducing the calculated required treatment volume.

If a site does not meet the non-DCIA, the elimination of curbs or curb cuts, etc. can still be used to direct flow onto grassed verges, vegetated swales or rain gardens. It can be used to retrofit areas with existing curbs, by making cuts at low points in the curb to direct runoff onto other green infrastructure stormwater features.



Think this...



...instead of this.

(a) **Design Considerations:** The first design decision is whether curbs are needed at all. In many residential communities, curbs are unnecessary. In commercial and other public areas, curbs are often desired to maintain proper traffic patterns. Tire stops can also serve this purpose. If curbs are desired, eliminating stormwater inlets and piped conveyances can still be considered if runoff is directed to pervious areas through curb cuts. Whether gutters are required depends on how stormwater is being treated and managed downstream. If curb cuts are to be used, their number, placement and design should be evaluated.

- An opening 18 inches wide is recommended to reduce the potential for clogging.
- The sides can be vertical or angled at 45 degrees.
- The bottom of the curb cut must slope away from the pavement.
- A 2" drop is recommended between the pavement and the vegetated area.
- Consider whether a concrete pad or gravel area is needed to dissipate energy and prevent erosion at entry points to rain gardens or parking lot islands.

Note, the street profile must match the intended drainage; i.e., a crowned street will drain to both sides, or a side shed profile will drain to only one side.

(b) **Maintenance:** Inspections are required periodically to check that runoff is flowing as intended, that any curb cuts are not blocked by sediment or debris, and that soil in the downstream vegetated area is not being eroded.

6.8. Source Control BMPs

Often the most cost effective and simple stormwater volume and water quality goals are accomplished by managing rainfall and stormwater runoff at the source. **Source control techniques** can be defined as nonstructural BMPs that reduce the amount of stormwater that runs off a site (**volume source controls**), or act as a preventative to lessen the nutrients and other pollutants that are picked up and carried by stormwater (**load source controls**). These can include many strategies ranging from disconnecting impervious areas to minimizing paved areas to education programs to teach homeowners to use less fertilizer on their [Florida-Friendly Landscapes™](#). Source controls are usually low cost, simple techniques that could be described as the “ounce of prevention” that is worth more than a “pound of cure”.

Typically, the most expensive elements of conventional stormwater systems are the conveyance and treatment structures, particularly as the physical distance from the source to a discharge point increases. When a site is proposed for development or redevelopment, the easiest way to maintain or restore the predevelopment hydrology is to implement control measures as close as possible to the source. Suites of distributed, source control strategies at the lot or project level are the keystones of green infrastructure BMP treatment trains.

6.8.1. Protect Surface Waters and Wetlands

Surface waters is a comprehensive term that includes all rivers, streams, creeks, springs, lakes, ponds, intermittent water courses and associated wetlands that hold or transport water on the ground surface. Protect surface waters and wetland edges by using buffers and native plantings. Required buffers around surface waters or wetlands should be maintained by retaining existing, undisturbed vegetation. The appropriate width of the buffer is determined on a case-by-case basis following a site inspection by the County. Among the factors considered are the potential for adverse impacts both on and off-site, the type of water to be protected and plant and animal communities present.

[Chapter 166 of the Pinellas County Land Development Code](#) establishes buffer requirements for wetlands and other natural resource areas.

6.8.2. Use Selective Site Clearing and Grading

To preserve the natural topography and avoid disturbing native soils, carefully plan clearing, grading, and construction. Then clearly delineate the areas on the ground and instruct all construction personnel on their purpose and importance. This will minimize soil compaction over the entire site - the ultimate goal being completely undisturbed soil in all areas except the building and impervious surface footprint. Use existing roads, future road areas, or previously compacted areas for materials staging.

6.8.3. Retain Natural Landscape Depressions

Natural depressions in the landscape are Mother Nature’s retention systems. They should be preserved where possible to promote storage, infiltration, and treatment of stormwater. Lot lines can be determined in part by location of natural depressions, and one or more per lot can be used to install rain gardens on individual lots. In addition to being green infrastructure assets, these natural landscape depressions can be potential environmental and marketing (homeowner) amenities.

6.8.4. Minimize Soil Disturbance and Compaction

The fertility, infiltration capacity, extent of compaction and stability of native soils will constrain the landscape design and management plan to varying extents. All green infrastructure BMP projects should evaluate the likely impacts of development on site soils and attempt to minimize adverse impacts. This should be done to the maximum extent possible throughout the project by preserving and protecting planned vegetated areas and protecting soils that will not be covered by impervious materials.

As demonstrated in the adjacent table, research on infiltration rates of sandy soils has demonstrated that compaction by construction equipment reduces infiltration rates by between 80 and 99 percent. This has a greater impact than the soil classification in many cases, and stormwater runoff may be significantly

underestimated by ignoring the effects of compaction.

Compaction of the top 6 inches is primarily related to tire pressure, and compaction of greater depths is related to the total weight of the equipment, affecting primarily the top foot of soil, but some compaction continues up to 3 feet. The degree of compaction varies with the soil type, pH, the organic and mineral content and moisture level. The upper layers of sandy soil can recover in 4-9 years, but some soils with high clay content have taken more than 40 years to recover. ⁱ

Remember that regardless of how well a structural infiltration-based BMP is designed, it will only achieve its design goals if the infiltration capacity of site soils meets design standards. Similarly, even the hardiest and most drought-tolerant trees and plantings cannot thrive if the soils in which they are planted have been excessively compacted. Although soils disturbed during site preparation and construction should be amended with compost to restore some permeability and infiltration capacity, most soils cannot be returned to their natural state. Avoiding compaction is far preferable and less expensive. It is imperative that sites intended for infiltration BMPs be clearly designated and not traversed by heavy construction equipment.

Table 6.8.4. Changes in Infiltration Rates from Soil Compaction

SOIL TYPE	INFILTRATION RATE (IN/HR)	
	PITT ET. AL. (Alabama)	GREGORY (Alachua County)
Sandy Soils	13.0	14.8 - 25
Compacted Sandy Soils	1.4	0.3 – 6.9
Clay Soils	9.8	NA
Compacted Clay Soils	0.2	NA

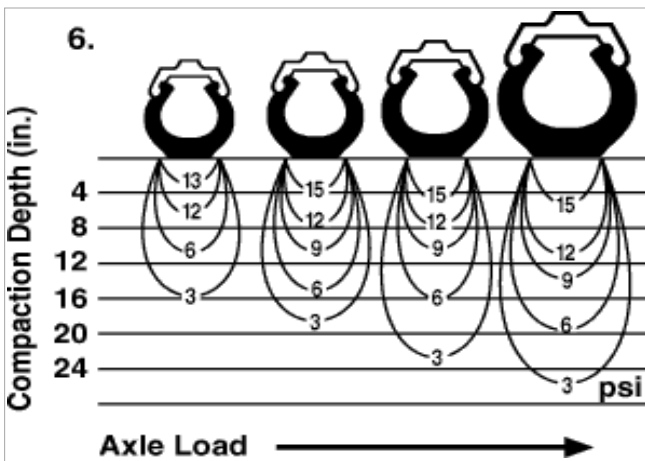

Up to 80% of compaction occurs during the first pass of a vehicle!

Figure 6.8.a – Soil Compaction and Depth Exhibit.

6.8.5. Build with the Landscape Slope

Retain the natural slope of the landscape by designing buildings and infrastructure around existing topography, rather than re-contouring the land to fit the building design. Build with the slope of the landscape by considering stem wall construction or pier and beam/raised floor foundations (rather than the traditional slab-on-grade) for homes and buildings. Raised floor construction without exterior fill on sloped sites reduces fill needs and lot-level soil disturbance.

6.8.6. Retain Native Landscapes at the Lot Level

Minimize the planned area requiring imported or constructed landscapes. Plant and maintain Florida-friendly or native vegetation wherever possible (i.e. celebrate Florida's native plant diversity). Minimize use of turf grass except where outside active recreation is planned and frequent. Plant native vegetation in beds that will require little or no irrigation after establishment. Native trees and shrubs can be watered with temporary perforated hoses laid on top of the ground and covered by mulch.

6.8.7. [Florida-Friendly Landscaping™](#) and Fertilizer Use

Recent studies have shown that nitrate levels are rising in many local water bodies, especially springs. Nitrate is a form of nitrogen that is found in inorganic fertilizers. If applied incorrectly, nitrogen can leach into our ground water or wash off the land and into lakes, rivers and the Gulf. Once in our water bodies, nutrients from fertilizer may cause algae to grow. Algae can form large blooms that shade out beneficial aquatic plants and use oxygen that fish need to survive.

Minimize new landscaped areas requiring supplemental inputs of fertilizer and irrigation by creating a [Florida-Friendly Landscape™](#). Plan your site for low-maintenance and resource-efficient landscapes that have the capacity to thrive without supplemental inputs of irrigation, fertilizers, pesticides, herbicides, etc. For the entire site, minimize the area of landscapes that require irrigation. Minimize turf lawns, replace turf with native drought tolerant vegetation, and/or plant drought-tolerant grasses for Pinellas County (such as Bahia, Zoysia, or Seashore Paspalum) to reduce irrigation demand. [Pinellas County Chapter 58, Landscape Maintenance and Fertilizer](#)



Photo Credit: SWFWMD

regulates use of urban landscape fertilizers. These rules are intended to reduce potential pollution that might result from application of excess fertilizer to lawns. For more information on proper fertilizer use in Pinellas County visit <http://www.pinellascounty.org/fertilizer>.

To protect Pinellas County's numerous lakes, streams, and estuarine waters from nutrient pollution, the County Adopted [the Landscape Maintenance and Fertilizer Use and Application Ordinance](#) in 2010.

The ordinance requires that all granular landscape fertilizer sold and used in the County meet or exceed a 50% Slow Release Nitrogen (SRN) requirement. Further, liquid fertilizers containing nitrogen cannot be applied at an application rate greater than 0.5 lbs. of readily available nitrogen per 1000 sq. ft. at any time based on the soluble fraction of formulated fertilizer.

TURF SPECIES	Bahia grass	Bermuda	Centipede	St. Augustine	Zoysia
Timing of Application: Only apply fertilizer to actively growing turf (needs mowing at least once every two weeks) between October 1 and May 31.					
Maximum pounds of Nitrogen per fertilizer application					
Spring	2	2	2	2	2
Fall or Winter	1	1	1	1	1
Maximum Annual Pounds	2-4	3-4	2-3	2-4	2-4

Additional ordinance requirements:

- Not more than 1 lbs. of total nitrogen per 1000 sq. ft. per application may be applied during the spring,
- Not more than 1 lb. total nitrogen per 1000 sq. ft. per application may be applied during the fall or winter, and
- No more than 4 lbs. of nitrogen may be applied annually.
- No fertilizer containing nitrogen and/or phosphorus may be applied to turf and/or landscape plants during the restricted season from June 1 through September 30.
- Because local soils contain naturally occurring phosphorus, fertilizer containing phosphorous cannot be used unless a soil test approved by the County demonstrates a deficiency exists.
- Nitrogen fertilizer will not be applied on newly established turf or new landscape plants for the first 30 days.
- Fertilizer will not be applied within ten feet from the top of bank (TOB) of any surface water, landward edge of the top of a seawall, designated wetland or wetland.
- Since irrigation with reclaimed water provides both nitrogen and phosphorus to the landscape it is recommended that fertilizer be further reduced to prevent water quality degradation. Reclaimed water quality information is available at www.pinellascounty.org/fertilizer.
- All commercial fertilizer applicators will have been trained in the [Florida Green Industry BMP Program](#), or equivalent, as required in [Section 403.9338, F.S.](#), and certified pursuant to the requirements in [Section 482.1562, F.S.](#) and [Chapter 58, Landscape Maintenance and Fertilizer Use of the Pinellas County Code of Ordinances](#).
- All landscape maintenance professionals will be certified through a County approved program pursuant to the requirements of [Chapter 58, Landscape Maintenance and Fertilizer Use of the Pinellas County Code of Ordinances](#).



Stormwater Treatment Credit - Developments designed in accordance with the principles of the [Florida-Friendly Landscaping™ program](#), will receive a three percent (3%) nutrient load reduction credit. Since this is a Source Control BMP that minimizes the amount of nitrogen and phosphorus fertilizer applied, the load reduction credit can be claimed first when performing nutrient loading calculations.

Conditions for Credit - A development project will meet all of the conditions outlined below to qualify for the Florida-Friendly Landscaping™ stormwater treatment credit:

- The entire development project will have all landscaping designed and constructed in accordance with the principles of the Florida Yards and Neighborhoods program including 6.8.8. of this manual.

- The development will implement, and record deed restrictions and other restrictive covenants based on the Model FYN Deed Restrictions and Restrictive Covenants.
- All fertilizers and their application will be consistent with the requirements in [Chapter 58, Landscape Maintenance and Fertilizer Use of the Pinellas County Code of Ordinances](#).
- All landscape maintenance will be consistent with the provisions of the [County's Landscape Management Best Management Practices certification program](#).
- The publication entitled *A Guide for Homeowners: Preventing Urban Runoff Pollution* available at <http://www.pinellascounty.org/fertilizer> will be provided to each new buyer within the development.

6.8.8. Install Efficient Irrigation Systems

Rain sensors or rain shut-off device are designed to interrupt the cycle of an automatic irrigation system when a specific amount of rainfall has occurred.

Florida is one of just a few states with a rain sensor statute. The most recent version of this statute (2010) states: "Any person who operates an automatic landscape irrigation system will properly install, maintain, and operate technology that inhibits or interrupts operation of the system during periods of sufficient moisture." ([Florida Statute 373.62](#)). Thus, all automatic landscape irrigation systems require rain sensors, or other shut off devices such as soil moisture sensor irrigation controllers.

When irrigation is necessary, use water conserving, low flow, programmable, and/or targeted irrigation systems. Landscaping beds with shrubs will be on separate zones from turf and drip irrigation is recommended. If native plants are used, irrigation may be removed or turned off after they are well established, approximately one year. Many different types of irrigators are available. Consider which is most efficient for each application. To maximize irrigation efficiency of automatic in-ground irrigation systems, consider smart water application technologies such as evapotranspiration (ET) controllers or soil moisture sensors (SMS). When using soil moisture sensors, the run time for each irrigation zone can be divided into several short cycles, allowing the moisture level to be checked between cycles to optimize the amount of water delivered.

Grasses are dormant during winter from about November until mid-March. Dormant grasses require little to no watering. Watering may be needed in April, May, and October since those months are usually dry. Irrigate in the hour before dawn to reduce water loss due to evaporation or wind. Irrigate only one or two days per week (as per current Water Management District watering regulations). Use rain monitors and/or soil moisture sensors to reduce unnecessary water use and regulate irrigation timers. Where possible, irrigate with non-potable water such as rainwater (See Rainfall Harvesting BMP), stormwater (See Stormwater Harvesting BMP), or reclaimed water. Further, if using reclaimed water, be sure to find out the concentration of nitrogen and phosphorus and avoid overwatering and/or overspray onto impervious surfaces.



A soil moisture sensor, buried in the turf root zone prevents irrigation when it is not needed.

This will increase runoff and nutrient loading to downstream stormwater conveyances and water bodies.

6.8.9. Use Non-Potable Water Supply for Irrigation

Incorporate non-potable water as the primary source for irrigation: reclaimed water, roof runoff stored in rain barrels or cisterns, or harvested stormwater. At the lot level, consider rainwater harvesting with cisterns or rain barrels for subsequent use to irrigate landscapes. While the relatively small volume stored in rain barrels will not measurably reduce stormwater from the site, they may be sufficient for irrigating small garden areas and may increase occupant's awareness of water use and promote conservation.



A rainwater harvesting cistern used for irrigation.

6.8.10. Community and Homeowner Education

All community developments should include a community or homeowner education program. This is especially true for developments that incorporate green infrastructure BMPs into their stormwater treatment train.

- Place signs in public areas to inform residents about natural resources, with panels that can be easily changed as desired to teach about different issues.
- Establish a website for residents gives wide ranging information, including water and energy efficiency, native landscaping, conservation of resources, waste reduction and local wildlife identification.
- Provide information brochures to prospective and new homeowners to introduce them to the community, its resources and efforts to protect natural resources.

6.9. Performance Monitoring and Maintenance

6.9.1. Evaluating the Effectiveness of the Stormwater Management System

A stormwater management system must be evaluated on its ability to reduce both the hydrologic and pollutant loading effects associated with any development or redevelopment project. The goal of green infrastructure is a stormwater and land use management strategy that strives to mimic pre-disturbance hydrologic characteristics. Reducing stormwater pollutant loads is accomplished largely by reducing the volume of stormwater that is discharged from a site. Therefore, evaluating a stormwater management system's hydrologic benefits requires an assessment of the change in stormwater volume before and after a project is completed. The amount of stormwater volume reduction will depend on the site's soil types, seasonal high water table conditions, and the non-structural and structural BMPs used at the site.

6.9.2. Best Management Practices (BMP) Presumptions

Stormwater management systems designed and constructed in accordance with the criteria in this manual are presumed to achieve a specific level of rate, volume or pollutant load reduction. Consequently, monitoring of the quality or quantity of the stormwater discharged from a permitted stormwater management system typically is not required. However, the presumption of performance depends on the stormwater system being properly operated, inspected, and maintained to ensure that it continues to function as permitted. The County reserves the right to require monitoring in cases where alternative methods are employed for stormwater management or when atypical conditions exist.

6.9.3. Inspections

Section 1.8 of this manual specifies inspection standards for the various types of structural BMPs used in Pinellas County. The County reserves the right to require monitoring of the discharge from any permitted stormwater management system, especially those discharging to impaired waters.

6.10 Design References

6.10.1 Calculation of Runoff Rates

For sites with a total area of one-acres or less, the Rational Method may be used to determine peak runoff rates. This method relates peak rate of runoff or discharge to rainfall intensity, drainage area, and soil and land use/cover characteristics by the equation:

$$Q = CiA$$

Where:

Q = Peak rate of runoff, in cubic feet per second.

C = Runoff coefficient representing a ratio of runoff rate to rainfall intensity (dimensionless).

i = Rainfall intensity, in inches/hour, which is expected to occur for a duration equal to the time of concentration of the drainage area represented by A.

A = Area of drainage basin, in acres.

Equation 6.10.1

6.10.2 Calculating Stormwater Pollutant Loading

A methodology for calculating site-specific annual average stormwater pollutant loadings is provided below. However, other continuous simulation methods, such as EPA SWMM, ICPR version 4, or other public or proprietary software approved by the County, may also be used to calculate pre-development and post-development hydrology and loadings.

6.10.3 Calculation of Pre-Development and Post-Development Hydrology

To calculate hydrology and pollutant loading from the proposed project, develop a table similar to Table 6.10.1. to summarize land use information. Determine the pre-development and post-development characteristics of each of the individual watersheds or drainage basins at the project site. The directly connected impervious area (DCIA) consists of those impervious areas that are directly connected to the stormwater conveyance system. Impervious areas also are considered to be DCIA if stormwater from the area occurs as concentrated shallow flow over a short pervious area such as grass or a swale. Non-directly connected impervious areas include all pervious areas and portions of impervious areas that flow over pervious areas sufficient to allow infiltration before significant runoff volumes are generated.

Table 6.10.1 Example Land Use Categories Matrix to Calculate Loadings

	<i>Total watershed area</i>	<i>Non-DCIA CN</i>	<i>DCIA percentage</i>
Pre-development			
Low Density Residential			
Single Family			
Multi-Family			
Low Intensity Commercial			
High Intensity Commercial			
Light Industrial			
Highway			
Natural Vegetated Community			
Golf Courses			
Post-development			
Low Density Residential			
Single Family			
Multi-Family			
Low Intensity Commercial			
High Intensity Commercial			
Light Industrial			
Highway			
Natural Vegetated Community			

The Manual provides tabular solutions to a series of calculations for determining annual runoff volumes in Precipitation Zone 4 (not to be confused with the FDOT IDF data Zone 6 which encompasses Pinellas County). Table 6.10.2 summarizes the calculated mean annual runoff coefficients (“C value”) as a function of curve number and DCIA in Precipitation Zone 4. These values reflect the average long-term runoff coefficients (C Values) over a wide range of DCIA and curve number combinations. The information contained in Table 6.10.1 is used to estimate the annual runoff volume for a given parcel under either pre- or post- development conditions. The mean annual rainfall depth (51”) is multiplied by the appropriate mean annual runoff coefficient (C value) based upon the DCIA and curve number characteristics of the site as follows:

Equation 6.10.2 Annual Runoff Volume (ac-ft.) =

$$\text{Area (acres)} \times \text{Mean Annual Rainfall (inches)} \times \text{C Value} \times \frac{1 \text{ ft}}{12 \text{ in}}$$

Linear interpolation can be used to estimate annual runoff coefficients for combinations of DCIA and curve numbers that fall between the values in the Table. For “naturally occurring” undeveloped conditions it should be assumed that the percent DCIA is equal to 0.0.

Zone 4 Mean Annual Runoff Coefficients (C Values) as a Function Of DCIA Percentage and Non-DCIA Curve Number (CN)																					
NDCIA CN	Percent DCIA																				
	0	5	10	15	20	25	30	35	40	45	50	55	60	65	70	75	80	85	90	95	100
30	0.004	0.045	0.086	0.127	0.168	0.209	0.250	0.291	0.332	0.373	0.414	0.455	0.496	0.536	0.577	0.618	0.659	0.700	0.741	0.782	0.823
35	0.007	0.048	0.089	0.129	0.170	0.211	0.252	0.293	0.333	0.374	0.415	0.456	0.497	0.537	0.578	0.619	0.660	0.701	0.741	0.782	0.823
40	0.011	0.051	0.092	0.133	0.173	0.214	0.254	0.295	0.336	0.376	0.417	0.458	0.498	0.539	0.579	0.620	0.661	0.701	0.742	0.782	0.823
45	0.016	0.056	0.096	0.137	0.177	0.217	0.258	0.298	0.339	0.379	0.419	0.460	0.500	0.540	0.581	0.621	0.662	0.702	0.742	0.783	0.823
50	0.022	0.062	0.102	0.142	0.182	0.222	0.262	0.302	0.342	0.382	0.423	0.463	0.503	0.543	0.583	0.623	0.663	0.703	0.743	0.783	0.823
55	0.030	0.070	0.109	0.149	0.189	0.228	0.268	0.308	0.347	0.387	0.427	0.466	0.506	0.546	0.585	0.625	0.664	0.704	0.744	0.783	0.823
60	0.040	0.080	0.119	0.158	0.197	0.236	0.275	0.314	0.353	0.393	0.432	0.471	0.510	0.549	0.588	0.627	0.667	0.706	0.745	0.784	0.823
65	0.054	0.092	0.131	0.169	0.208	0.246	0.285	0.323	0.362	0.400	0.438	0.477	0.515	0.554	0.592	0.631	0.669	0.708	0.746	0.785	0.823
70	0.071	0.109	0.147	0.184	0.222	0.259	0.297	0.335	0.372	0.410	0.447	0.485	0.522	0.560	0.598	0.635	0.673	0.710	0.748	0.785	0.823
75	0.096	0.132	0.168	0.205	0.241	0.277	0.314	0.350	0.387	0.423	0.459	0.496	0.532	0.568	0.605	0.641	0.678	0.714	0.750	0.787	0.823
80	0.130	0.165	0.199	0.234	0.268	0.303	0.338	0.372	0.407	0.442	0.476	0.511	0.546	0.580	0.615	0.650	0.684	0.719	0.754	0.788	0.823
85	0.182	0.214	0.246	0.278	0.310	0.342	0.374	0.406	0.438	0.470	0.502	0.534	0.566	0.599	0.631	0.663	0.695	0.727	0.759	0.791	0.823
90	0.266	0.294	0.322	0.350	0.378	0.406	0.433	0.461	0.489	0.517	0.545	0.573	0.600	0.628	0.656	0.684	0.712	0.740	0.767	0.795	0.823
95	0.429	0.449	0.469	0.488	0.508	0.528	0.547	0.567	0.587	0.606	0.626	0.646	0.665	0.685	0.705	0.725	0.744	0.764	0.784	0.803	0.823
98	0.616	0.626	0.636	0.647	0.657	0.667	0.678	0.688	0.699	0.709	0.719	0.730	0.740	0.750	0.761	0.771	0.782	0.792	0.802	0.813	0.823

Table 6.10.2. Mean Annual Runoff Coefficient

6.10.4. Calculation of Pre-Development (Current) Stormwater Pollutant Loading

The pre-development annual mass loadings of total phosphorus and total nitrogen are calculated by multiplying the pre-development annual runoff volume (derived in **Section 6.10.3**) by the land use specific runoff characterization data (event mean concentrations or EMCs) for Total Phosphorus (TP) and Total Nitrogen (TN) listed in **Table 6.10.3** for pre-development land use conditions. The mass loading calculation is provided as **Equation 6.10.3**.

Equation 6.10.3. Annual Mass Loading = Annual Runoff Volume x EMC

The various components of Equation 6.10.3 are expressed in different units and require some conversion factors, as provided below.

$$\text{Annual Mass Loading (lb./year)} = \text{Annual Runoff Volume (ac-ft./year)} \times 43,560 \text{ ft}^2/\text{ac} \times 7.48 \text{ gal/ft}^3 \times 3.785 \text{ liter/gal} \times \text{EMC (mg/l)} \times 1 \text{ lb./453,592 mg}$$

Table 6.10.3. Stormwater Pollutant Loading Input Data

<i>Annual Rainfall</i>	<i>51" Rainfall Zone 4 for BMP Trains Model</i>					
Stormwater Event Mean Concentrations (mg/l)						
Land Use Category	Total N	Total P	BOD	TSS	Copper	Zinc
Low Density Residential ¹	1.61	0.191	3.95	18.75	0.008	0.0031
Single Family	2.07	0.327	7.9	37.5	0.016	0.062
Multi-Family	2.32	0.520	11.30	77.90	0.009	0.086
Low Intensity Commercial	1.13	0.186	7.60	59.90	0.017	0.083
High Intensity Commercial	2.40	0.345	11.30	69.90	0.015	0.160
Light Industrial	1.20	0.260	7.60	60.00	0.003	0.057
Highway	1.52	0.200	5.20	46.00	0.025	0.116
Natural Vegetated Community	1.15	0.55	1.9	4.7	0.003	0.007
Agricultural Land Uses						
Pasture	3.51	0.686	5.10	67.10	-	-
Citrus	2.24	0.183	2.60	15.50	0.003	0.012
Row Crops	2.65	0.593	-	19.80	0.022	0.030
Conventional rooftops	1.05	0.12				
1. Average of single-family and undeveloped values						

6.10.5 Calculation of Post-Development Stormwater Pollutant Loading

The post-development annual mass loadings of total phosphorus and total nitrogen are calculated similarly to the pre-development loadings by multiplying the post-development annual runoff volume (derived in Section 6.10.3) by the land use specific runoff characterization data (event mean concentrations or EMCs) for total phosphorus and total nitrogen listed in Table 6.10.3 for post-development land use conditions. The mass loading calculation is provided as Equation 6.10.3.

6.10.6 Designing the BMP Treatment Train to Meet Required Load Reductions

Once the pre-development and post-development loadings have been calculated and the required percent reduction of TN and TP have been established, the stormwater BMP treatment train can be designed. This Manual includes a variety of BMPs, both nonstructural and structural, that can be used to reduce nutrients in stormwater discharges. Stormwater treatment systems are generally most effective when designed to include a combination of BMPs in series to achieve the required pollutant removal efficiency. This concept is called the “BMP treatment train”.

Treatment efficiencies of BMPs in series must account for the reduced loading transferred to subsequent downstream treatment devices. After treatment occurs in the first system, a load reduction has occurred which is a function of the type of BMP used to provide treatment. After load reduction in the initial BMP, the remaining load consists of pollutant mass that was not removed. This mass is then treated by the second BMP with the nutrient reduction efficiency determined by the particular type of BMP used.

As stormwater pollutant concentrations or stormwater volumes are reduced in each BMP in the treatment train, the ability of a BMP to further reduce stormwater pollutant concentrations and loads is reduced. The treatment efficiency used for downstream BMPs must account for the diminishing effectiveness of stormwater treatment. Examples of how to calculate the overall pollutant load reduction effectiveness of a BMP Treatment Train, including where there are multiple inflow locations, are contained in the Case Studies in the Appendices of this Manual. BMP design examples provided in Chapter 6 illustrate the use of multiple wet ponds and multiple dry retention basins in series.

To assist designers in determining the pollutant load reduction effectiveness of proposed stormwater systems, the University of Central Florida Stormwater Management Academy has created the BMPTRAINS Model software. This model is available online at <http://www.stormwater.ucf.edu/>.

First, select the BMPs that will be used to meet the required TP load reductions. Information on the nutrient load reduction credits for individual BMPs is provided in Chapter 5 of this Manual. In addition, a summary of DEP’s BMP pollutant load reduction credits used in the TMDL/BMAP program is provided in Appendix D. Once the BMPs for TP load reductions are selected, determine if the BMPs used to meet the required TP load reduction will achieve the required level of TN load reduction. Typically, for retention systems they will but for wet detention systems they will not. If they do, complete the design of the stormwater treatment system. If they do not, either modify the selected BMPs or add BMPs to increase the pounds of TN reduction until the system meets the required amount of load reduction.

6.10.7 Tables to assist with determining load reduction efficiencies:

Table 6.10.4. Required Retention Treatment Volumes (in Inches) to Achieve an 80% Average Annual Pollutant Load Reduction - (From Evaluation of Current Stormwater Design Criteria within the State of Florida, Final Report Submitted to the FDEP, June 2007, Harvey Harper and David Baker, Environmental Research and Design, Inc.)

Coastal (Zone 4)																			
NDCIA CN	Percent DCIA																		
	10	15	20	25	30	35	40	45	50	55	60	65	70	75	80	85	90	95	100
30	0.23	0.27	0.37	0.44	0.50	0.59	0.67	0.73	0.81	0.89	0.96	1.04	1.12	1.20	1.27	1.35	1.43	1.51	1.59
35	0.24	0.29	0.39	0.45	0.51	0.60	0.67	0.74	0.82	0.90	0.97	1.05	1.13	1.20	1.28	1.36	1.43	1.51	1.59
40	0.26	0.33	0.41	0.46	0.52	0.61	0.69	0.75	0.83	0.91	0.98	1.05	1.13	1.21	1.28	1.36	1.43	1.51	1.59
45	0.31	0.37	0.43	0.48	0.55	0.63	0.70	0.76	0.85	0.92	0.99	1.06	1.14	1.21	1.29	1.36	1.44	1.51	1.59
50	0.40	0.42	0.46	0.51	0.59	0.66	0.72	0.79	0.87	0.93	1.00	1.08	1.15	1.22	1.29	1.37	1.44	1.51	1.59
55	0.51	0.48	0.51	0.56	0.63	0.69	0.75	0.82	0.89	0.95	1.02	1.09	1.16	1.23	1.30	1.37	1.44	1.51	1.59
60	0.65	0.58	0.59	0.63	0.68	0.73	0.78	0.85	0.92	0.98	1.04	1.11	1.18	1.24	1.31	1.38	1.45	1.51	1.59
65	0.80	0.72	0.70	0.71	0.74	0.78	0.84	0.90	0.95	1.01	1.07	1.14	1.20	1.26	1.33	1.39	1.45	1.52	1.59
70	0.96	0.86	0.82	0.81	0.83	0.87	0.91	0.95	1.00	1.05	1.11	1.17	1.22	1.28	1.34	1.40	1.46	1.52	1.59
75	1.10	1.01	0.97	0.95	0.95	0.97	0.99	1.02	1.07	1.11	1.16	1.21	1.26	1.31	1.37	1.42	1.47	1.53	1.59
80	1.24	1.16	1.11	1.09	1.08	1.08	1.10	1.12	1.15	1.19	1.22	1.26	1.30	1.35	1.39	1.44	1.49	1.53	1.59
85	1.36	1.30	1.26	1.23	1.22	1.22	1.23	1.24	1.25	1.28	1.30	1.33	1.36	1.40	1.43	1.47	1.50	1.54	1.59
90	1.47	1.43	1.40	1.38	1.37	1.36	1.36	1.37	1.38	1.39	1.40	1.42	1.44	1.46	1.48	1.50	1.53	1.56	1.59
95	1.54	1.53	1.52	1.51	1.51	1.50	1.50	1.50	1.50	1.51	1.51	1.52	1.52	1.53	1.54	1.55	1.56	1.57	1.59
98	1.56	1.56	1.56	1.56	1.56	1.56	1.56	1.56	1.56	1.56	1.56	1.56	1.57	1.57	1.57	1.58	1.58	1.58	1.59

Table 6.10.5. Dry Retention System Mean Annual Nutrient Load Reduction Efficiency For Various Runoff Depths As A Function Of DCIA And Non-DCIA Curve Number (Rainfall Zone 4) - (From Evaluation of Current Stormwater Design Criteria within the State of Florida, Final Report Submitted to the FDEP, June 2007, Harvey Harper and David Baker, Environmental Research and Design, Inc.)

Mean Annual Mass Removal Efficiencies (%) for 0.10 inches of Retention for Zone 4																		
NDCIA CN	Percent DCIA																	
	0-15	20	25	30	35	40	45	50	55	60	65	70	75	80	85	90	95	100
30	50.2	41.7	35.6	31.0	27.4	24.6	22.4	20.5	18.9	17.5	16.3	15.3	14.3	13.5	12.8	12.2	11.6	11.1
35	49.3	41.1	35.2	30.7	27.3	24.5	22.3	20.4	18.8	17.4	16.3	15.2	14.3	13.5	12.8	12.2	11.6	11.1
40	48.2	40.4	34.8	30.4	27.0	24.3	22.1	20.3	18.7	17.4	16.2	15.2	14.3	13.5	12.8	12.2	11.6	11.1
45	46.7	39.6	34.2	30.0	26.8	24.1	22.0	20.2	18.6	17.3	16.2	15.2	14.3	13.5	12.8	12.2	11.6	11.1
50	45.0	38.5	33.4	29.5	26.4	23.9	21.8	20.1	18.5	17.2	16.1	15.1	14.2	13.5	12.8	12.2	11.6	11.1
55	42.9	37.1	32.5	28.9	25.9	23.5	21.5	19.9	18.4	17.1	16.0	15.0	14.2	13.4	12.8	12.1	11.6	11.1
60	40.5	35.6	31.5	28.1	25.4	23.1	21.2	19.6	18.2	17.0	15.9	15.0	14.1	13.4	12.7	12.1	11.6	11.1
65	37.8	33.7	30.2	27.2	24.7	22.6	20.8	19.3	18.0	16.8	15.8	14.9	14.1	13.3	12.7	12.1	11.6	11.1
70	34.8	31.6	28.7	26.1	23.9	22.0	20.3	18.9	17.7	16.6	15.6	14.7	14.0	13.3	12.6	12.1	11.6	11.1
75	31.4	29.1	26.8	24.7	22.8	21.1	19.7	18.5	17.3	16.3	15.4	14.6	13.8	13.2	12.6	12.0	11.5	11.1
80	27.6	26.2	24.6	22.9	21.4	20.1	18.9	17.8	16.8	15.9	15.1	14.3	13.7	13.0	12.5	12.0	11.5	11.1
85	23.4	22.8	21.8	20.8	19.7	18.7	17.7	16.9	16.0	15.3	14.6	14.0	13.4	12.8	12.4	11.9	11.5	11.1
90	19.0	18.9	18.6	18.0	17.4	16.8	16.2	15.6	15.0	14.1	13.9	13.4	13.0	12.5	12.1	11.8	11.4	11.1
95	14.8	14.8	14.7	14.6	14.4	14.2	13.9	13.7	13.4	13.1	12.8	12.6	12.3	12.0	11.8	11.5	11.3	11.1
98	12.8	12.8	12.7	12.6	12.5	12.4	12.3	12.2	12.1	12.0	11.9	11.8	11.6	11.5	11.4	11.3	11.2	11.1

Mean Annual Mass Removal Efficiencies (%) for 0.20 inches of Retention for Zone 4																		
NDCIA CN	Percent DCIA																	
	0-15	20	25	30	35	40	45	50	55	60	65	70	75	80	85	90	95	100
30	72.8	64.2	57.0	51.1	46.3	42.2	38.8	35.9	33.4	31.2	29.3	27.6	26.1	24.8	23.6	22.5	21.5	20.6
35	71.5	63.4	56.5	50.7	46.0	42.0	38.6	35.8	33.3	31.2	29.3	27.6	26.1	24.8	23.6	22.5	21.5	20.6
40	69.8	62.3	55.7	50.2	45.6	41.7	38.4	35.6	33.2	31.1	29.2	27.6	26.1	24.7	23.5	22.5	21.5	20.6
45	67.7	60.9	54.8	49.5	45.1	41.4	38.2	35.4	33.0	30.9	29.1	27.5	26.0	24.7	23.5	22.5	21.5	20.6
50	65.2	59.2	53.6	48.7	44.5	40.9	37.8	35.2	32.8	30.8	29.0	27.4	25.9	24.7	23.5	22.4	21.5	20.6
55	62.3	57.2	52.2	47.7	43.7	40.3	37.4	34.8	32.6	30.6	28.9	27.3	25.9	24.6	23.4	22.4	21.5	20.6
60	59.0	54.9	50.5	46.4	42.8	39.6	36.8	34.4	32.3	30.3	28.7	27.1	25.8	24.5	23.4	22.4	21.4	20.6
65	55.2	52.1	48.5	44.9	41.7	38.8	36.2	33.9	31.8	30.0	28.4	27.0	25.6	24.4	23.3	22.3	21.4	20.6
70	51.0	48.9	46.1	43.1	40.2	37.7	35.3	33.2	31.3	29.6	28.1	26.7	25.4	24.3	23.2	22.3	21.4	20.6
75	46.3	45.3	43.2	40.8	38.5	36.3	34.2	32.4	30.6	29.1	27.7	26.4	25.2	24.1	23.1	22.2	21.4	20.6
80	41.2	41.0	39.7	38.0	36.2	34.5	32.8	31.2	29.7	28.4	27.1	26.0	24.9	23.9	23.0	22.1	21.3	20.6
85	36.0	36.0	35.5	34.5	33.4	32.1	30.9	29.7	28.5	27.4	26.3	25.3	24.4	23.5	22.7	22.0	21.3	20.6
90	30.7	30.7	30.6	30.2	29.6	29.0	28.2	27.4	26.6	25.9	25.1	24.4	23.7	23.0	22.3	21.7	21.1	20.6
95	25.4	25.4	25.4	25.3	25.1	24.9	24.6	24.3	23.9	23.6	23.2	22.8	22.4	22.1	21.7	21.3	20.9	20.6
98	22.8	22.7	22.6	22.6	22.5	22.4	22.2	22.1	22.0	21.8	21.7	21.5	21.4	21.2	21.1	20.9	20.8	20.6

Mean Annual Mass Removal Efficiencies (%) for 0.30-inches of Retention for Zone 4																		
NDCIA CN	Percent DCIA																	
	0-15	20	25	30	35	40	45	50	55	60	65	70	75	80	85	90	95	100
30	83.7	76.9	70.5	64.8	59.7	55.3	51.4	48.0	45.0	42.4	40.0	37.9	36.1	34.3	32.7	31.3	30.0	28.8
35	82.2	75.9	69.8	64.3	59.3	55.0	51.2	47.9	44.9	42.3	40.0	37.9	36.0	34.3	32.7	31.3	30.0	28.8
40	80.3	74.7	68.9	63.6	58.9	54.6	50.9	47.7	44.7	42.2	39.9	37.8	36.0	34.2	32.7	31.3	30.0	28.8
45	78.0	73.0	67.8	62.8	58.2	54.2	50.6	47.4	44.5	42.0	39.7	37.7	35.9	34.2	32.7	31.3	30.0	28.8
50	75.3	71.1	66.3	61.7	57.4	53.6	50.1	47.0	44.3	41.8	39.6	37.6	35.8	34.1	32.6	31.2	30.0	28.8
55	72.1	68.8	64.6	60.4	56.5	52.8	49.5	46.6	43.9	41.5	39.4	37.4	35.7	34.0	32.6	31.2	30.0	28.8
60	68.5	66.0	62.6	58.9	55.3	51.9	48.8	46.0	43.5	41.2	39.1	37.2	35.5	33.9	32.5	31.2	30.0	28.8
65	64.5	62.9	60.2	57.0	53.8	50.8	47.9	45.3	42.9	40.8	38.8	37.0	35.3	33.8	32.4	31.1	29.9	28.8
70	60.0	59.3	57.3	54.7	52.0	49.3	46.8	44.4	42.2	40.2	38.4	36.7	35.1	33.6	32.3	31.0	29.9	28.8
75	55.1	55.1	53.9	52.0	49.8	47.6	45.4	43.3	41.3	39.5	37.8	36.2	34.8	33.4	32.1	30.9	29.8	28.8
80	50.2	50.2	49.7	48.6	47.0	45.3	43.5	41.8	40.1	38.5	37.0	35.6	34.3	33.1	31.9	30.8	29.8	28.8
85	45.0	45.0	44.9	44.3	43.4	42.3	41.0	39.8	38.4	37.2	36.0	34.8	33.7	32.6	31.6	30.6	29.7	28.8
90	39.6	39.6	39.6	39.4	39.0	38.4	37.7	36.9	36.1	35.2	34.3	33.5	32.7	31.8	31.0	30.3	29.5	28.8
95	34.1	34.1	34.1	34.0	33.8	33.6	33.3	33.0	32.7	32.3	31.9	31.5	31.0	30.6	30.1	29.7	29.3	28.8
98	31.2	31.2	31.1	31.0	30.9	30.8	30.6	30.5	30.4	30.2	30.1	29.9	29.7	29.6	29.4	29.2	29.0	28.8

Mean Annual Mass Removal Efficiencies (%) for 0.40-inches of Retention for Zone 4																		
NDCIA CN	Percent DCIA																	
	0-15	20	25	30	35	40	45	50	55	60	65	70	75	80	85	90	95	100
30	89.1	84.4	79.1	74.1	69.3	65.0	61.1	57.6	54.4	51.6	49.0	46.6	44.4	42.5	40.7	39.0	37.5	36.1
35	87.6	83.3	78.4	73.5	68.9	64.7	60.9	57.4	54.3	51.4	48.9	46.5	44.4	42.5	40.7	39.0	37.5	36.1
40	85.8	81.9	77.4	72.8	68.4	64.3	60.6	57.2	54.1	51.3	48.8	46.4	44.3	42.4	40.6	39.0	37.5	36.1
45	83.5	80.2	76.1	71.8	67.6	63.7	60.1	56.8	53.8	51.1	48.6	46.3	44.2	42.4	40.6	39.0	37.5	36.1
50	80.8	78.2	74.6	70.6	66.7	63.0	59.6	56.4	53.5	50.8	48.4	46.2	44.1	42.3	40.5	38.9	37.5	36.1
55	77.8	75.8	72.7	69.2	65.6	62.2	58.9	55.9	53.1	50.5	48.2	46.0	44.0	42.2	40.5	38.9	37.4	36.1
60	74.2	73.0	70.5	67.5	64.3	61.1	58.1	55.2	52.6	50.1	47.8	45.7	43.8	42.0	40.4	38.8	37.4	36.1
65	70.3	69.8	67.9	65.4	62.6	59.8	57.0	54.4	51.9	49.6	47.4	45.4	43.6	41.9	40.3	38.8	37.4	36.1
70	66.0	66.0	64.8	62.9	60.6	58.2	55.7	53.4	51.1	48.9	46.9	45.0	43.3	41.7	40.1	38.7	37.4	36.1
75	61.7	61.7	61.2	59.9	58.1	56.1	54.1	52.0	50.0	48.1	46.2	44.5	42.9	41.4	39.9	38.6	37.3	36.1
80	57.0	57.0	56.9	56.2	55.0	53.6	51.9	50.3	48.6	46.9	45.3	43.8	42.3	41.0	39.6	38.4	37.2	36.1
85	52.0	52.0	52.0	51.7	51.1	50.2	49.1	47.9	46.6	45.3	44.0	42.8	41.5	40.4	39.2	38.1	37.1	36.1
90	46.8	46.8	46.8	46.8	46.4	46.0	45.3	44.6	43.8	43.0	42.1	41.2	40.3	39.5	38.6	37.7	36.9	36.1
95	41.4	41.4	41.4	41.3	41.2	41.0	40.7	40.4	40.1	39.7	39.3	38.9	38.5	38.0	37.5	37.1	36.6	36.1
98	38.5	38.4	38.4	38.3	38.2	38.1	37.9	37.8	37.7	37.5	37.4	37.2	37.0	36.9	36.7	36.5	36.3	36.1

Mean Annual Mass Removal Efficiencies (%) for 0.50-inches of Retention for Zone 4

NDCIA CN	Percent DCIA																	
	0-15	20	25	30	35	40	45	50	55	60	65	70	75	80	85	90	95	100
30	92.1	88.8	84.4	80.5	76.3	72.4	68.6	65.2	62.0	56.4	56.4	53.9	51.7	49.5	47.6	45.8	44.1	42.6
35	90.7	87.7	84.0	79.9	75.9	72.0	68.4	65.0	61.9	56.3	56.3	53.9	51.6	49.5	47.6	45.8	44.1	42.6
40	88.9	86.4	82.9	79.1	75.3	71.5	68.0	64.7	61.6	56.2	56.2	53.8	51.5	49.4	47.5	45.7	44.1	42.6
45	86.8	84.7	81.6	78.1	74.5	70.9	67.5	64.3	61.3	56.0	56.0	53.6	51.4	49.4	47.5	45.7	44.1	42.6
50	84.3	82.7	80.1	76.9	73.5	70.2	66.9	63.9	61.0	55.8	55.8	53.5	51.3	49.3	47.4	45.7	44.1	42.6
55	81.4	80.4	78.2	75.4	72.3	69.2	66.2	63.3	60.5	55.5	55.5	53.2	51.1	49.2	47.3	45.6	44.0	42.6
60	78.1	77.6	75.9	73.6	70.9	68.0	65.2	62.5	59.9	55.1	55.1	53.0	50.9	49.0	47.2	45.6	44.0	42.6
65	74.5	74.5	73.3	71.4	69.1	66.6	64.1	61.6	59.2	54.7	54.7	52.6	50.6	48.8	47.1	45.5	44.0	42.6
70	70.8	70.8	70.2	68.9	67.0	64.9	62.7	60.5	58.3	54.1	54.1	52.1	50.3	48.6	46.9	45.4	43.9	42.6
75	66.7	66.7	66.6	65.7	64.4	62.7	60.9	59.0	57.1	53.3	53.3	51.5	49.8	48.2	46.7	45.2	43.8	42.6
80	62.4	62.4	62.4	61.9	61.1	59.9	58.6	57.1	55.5	52.3	52.3	50.7	49.2	47.8	46.4	45.0	43.8	42.6
85	57.7	57.7	57.7	57.6	57.1	56.4	55.5	54.5	53.3	50.8	50.8	49.6	48.3	47.1	45.9	44.7	43.6	42.6
90	52.8	52.8	52.8	52.8	52.6	52.2	51.7	51.1	50.3	48.7	48.7	47.9	47.0	46.1	45.2	44.3	43.4	42.6
95	47.6	47.6	47.6	47.6	47.5	47.3	47.1	46.8	46.5	45.8	45.8	45.4	44.9	44.5	44.0	43.5	43.0	42.6
98	44.8	44.8	44.7	44.7	44.6	44.5	44.3	44.2	44.1	43.8	43.8	43.6	43.5	43.3	43.1	42.9	42.7	42.6

Mean Annual Mass Removal Efficiencies (%) for 0.60-inches of Retention for Zone 4

NDCIA CN	Percent DCIA																	
	0-15	20	25	30	35	40	45	50	55	60	65	70	75	80	85	90	95	100
30	94.0	91.6	88.6	85.1	81.5	77.9	74.5	71.3	68.2	65.3	62.6	60.1	57.8	55.6	53.6	51.7	49.9	48.3
35	92.6	90.6	87.7	84.5	81.0	77.5	74.2	71.0	68.0	65.2	62.5	60.1	57.8	55.6	53.6	51.7	49.9	48.3
40	91.0	89.2	86.7	83.6	80.3	77.0	73.8	70.7	67.8	65.0	62.4	59.9	57.7	55.5	53.5	51.7	49.9	48.3
45	89.0	87.6	85.4	82.6	79.5	76.4	73.3	70.3	67.4	64.7	62.2	59.8	57.6	55.4	53.5	51.6	49.9	48.3
50	86.7	85.7	83.8	81.3	78.5	75.6	72.6	69.8	67.0	64.4	61.9	59.6	57.4	55.3	53.4	51.6	49.9	48.3
55	84.0	83.5	82.0	79.8	77.3	74.6	71.8	69.1	66.5	64.0	61.6	59.4	57.2	55.2	53.3	51.5	49.9	48.3
60	80.9	80.9	79.8	78.0	75.8	73.4	70.9	68.3	65.9	63.5	61.2	59.0	57.0	55.0	53.2	51.5	49.8	48.3
65	77.9	77.9	77.3	75.9	74.0	71.9	69.6	67.4	65.1	62.9	60.7	58.7	56.7	54.8	53.1	51.4	49.8	48.3
70	74.5	74.5	74.2	73.3	71.9	70.1	68.2	66.1	64.1	62.1	60.1	58.2	56.3	54.5	52.9	51.3	49.7	48.3
75	70.8	70.8	70.8	70.2	69.2	67.8	66.3	64.6	62.8	61.0	59.2	57.5	56.8	54.2	52.6	51.1	49.7	48.3
80	66.8	66.8	66.8	66.6	65.9	65.0	63.9	62.6	61.1	59.6	58.1	56.6	55.1	53.7	52.3	50.9	49.5	48.3
85	62.5	62.5	62.5	62.4	62.1	61.5	60.8	59.9	58.8	57.7	56.6	55.4	54.1	52.9	51.7	50.5	49.4	48.3
90	57.9	57.9	57.9	57.9	57.8	57.5	57.0	56.5	55.9	55.1	54.4	53.5	52.7	51.8	51.0	50.0	49.2	48.3
95	53.0	53.0	53.0	53.0	52.9	52.8	52.6	52.4	52.1	51.8	51.4	51.0	50.6	50.2	49.7	49.3	48.8	48.3
98	50.4	50.4	50.3	50.3	50.2	50.1	50.0	49.9	49.7	49.6	49.5	49.3	49.2	49.0	48.8	48.7	48.5	48.3

Mean Annual Mass Removal Efficiencies (%) for 0.70-inches of Retention for Zone 4																		
NDCIA CN	Percent DCIA																	
	0-15	20	25	30	35	40	45	50	55	60	65	70	75	80	85	90	95	100
30	95.2	93.4	91.1	88.3	85.3	82.2	79.1	76.1	73.2	70.5	67.9	65.4	63.1	60.9	58.9	56.9	55.1	53.4
35	94.0	92.4	90.3	87.7	84.8	81.8	78.8	75.8	73.0	70.3	67.7	65.3	63.0	60.9	58.8	56.9	55.1	53.4
40	92.4	91.2	89.3	86.9	84.1	81.2	78.3	75.5	72.7	70.1	67.6	65.2	62.9	60.8	58.8	56.9	55.1	53.4
45	90.6	89.7	88.0	85.8	83.3	80.6	77.8	75.1	72.4	69.8	67.4	65.0	62.8	60.7	58.7	56.8	55.1	53.4
50	88.5	87.9	86.5	84.6	82.3	79.7	77.1	74.5	72.0	69.5	67.1	64.8	62.6	60.6	58.6	56.8	55.0	53.4
55	86.0	85.8	84.8	83.1	81.1	78.7	76.3	73.9	71.4	69.0	66.7	64.5	62.4	60.4	58.5	56.7	55.0	53.4
60	83.4	83.4	82.7	81.4	79.6	77.5	75.3	73.0	70.7	68.5	66.3	64.2	62.2	60.3	58.4	56.6	55.0	53.4
65	80.6	80.6	80.3	79.3	77.8	76.0	74.1	72.0	69.9	67.8	65.8	63.8	61.9	60.0	58.2	56.5	54.9	53.4
70	77.4	77.4	77.4	76.8	75.7	74.2	72.6	70.8	68.9	67.0	65.1	63.3	61.5	59.7	58.0	56.4	54.9	53.4
75	74.1	74.1	74.1	73.8	73.1	72.0	70.6	69.1	67.6	65.9	64.2	62.6	60.9	59.3	57.8	56.2	54.8	53.4
80	70.5	70.5	70.5	70.4	69.9	69.2	68.2	67.0	65.8	64.5	63.1	61.6	60.2	58.8	57.4	56.0	54.7	53.4
85	66.5	66.5	66.5	66.5	66.3	65.8	65.2	64.4	63.5	62.5	61.4	60.3	59.2	58.0	56.8	55.7	54.5	53.4
90	62.2	62.2	62.2	62.2	62.1	61.9	61.6	61.1	60.6	59.9	59.2	58.5	57.7	56.8	56.0	55.1	54.3	53.4
95	57.6	57.6	57.6	57.6	57.6	57.5	57.4	57.2	57.0	56.7	56.3	56.0	55.6	55.2	54.8	54.3	53.9	53.4
98	55.3	55.3	55.2	55.2	55.1	55.0	54.9	54.8	54.7	54.6	54.5	54.4	54.2	54.1	53.9	53.7	53.6	53.4

Mean Annual Mass Removal Efficiencies (%) for 0.80-inches of Retention for Zone 4																		
NDCIA CN	Percent DCIA																	
	0-15	20	25	30	35	40	45	50	55	60	65	70	75	80	85	90	95	100
30	96.0	94.7	92.9	90.7	88.2	85.5	82.7	80.0	77.3	74.7	72.2	69.9	67.6	65.5	63.4	61.5	59.7	57.9
35	94.9	93.8	92.1	90.0	87.6	85.1	82.4	79.7	77.1	74.6	72.1	69.8	67.5	65.4	63.4	61.5	59.6	57.9
40	93.5	92.6	91.2	89.2	87.0	84.5	81.9	79.4	76.8	74.3	71.9	69.6	67.4	65.3	63.4	61.4	59.6	57.9
45	91.9	91.2	90.0	88.2	86.2	83.8	81.4	78.9	76.4	74.0	71.7	69.5	67.3	65.2	63.3	61.4	59.6	57.9
50	89.9	89.6	88.6	87.0	85.2	83.0	80.7	78.4	76.0	73.7	71.4	69.2	67.1	65.1	63.2	61.4	59.6	57.9
55	87.6	87.6	86.9	85.6	84.0	82.0	79.9	77.7	75.4	73.2	71.1	69.0	66.9	65.0	63.1	61.3	59.6	57.9
60	85.3	85.3	84.9	84.0	82.5	80.8	78.9	76.8	74.8	72.7	70.6	68.6	66.6	64.8	62.9	61.2	59.5	57.9
65	82.7	82.7	82.6	81.9	80.8	79.3	77.6	75.8	73.9	72.0	70.1	68.2	66.3	64.5	62.8	61.1	59.5	57.9
70	80.0	80.0	80.0	79.5	78.7	77.5	76.1	74.5	72.9	71.1	69.4	67.6	65.9	64.2	62.5	61.0	59.4	57.9
75	76.9	76.9	76.9	76.7	76.2	75.3	74.2	72.9	71.5	70.0	68.5	66.9	65.3	63.8	62.3	60.8	59.3	57.9
80	73.6	73.6	73.6	73.6	73.2	72.6	71.8	70.8	69.7	68.5	67.2	65.9	64.6	63.2	61.9	60.5	59.2	57.9
85	70.0	70.0	70.0	70.0	69.8	69.5	68.9	68.2	67.4	66.6	65.6	64.6	63.5	62.4	61.3	60.2	59.0	57.9
90	66.0	66.0	66.0	66.0	66.0	65.8	65.5	65.1	64.6	64.1	63.4	62.7	62.0	61.2	60.4	59.6	58.8	57.9
95	61.7	61.7	61.7	61.7	61.7	61.7	61.6	61.4	61.2	60.9	60.7	60.4	60.0	59.6	59.2	58.8	58.4	57.9
98	59.6	59.6	59.6	59.5	59.5	59.4	59.3	59.2	59.1	59.0	58.9	58.8	58.7	58.5	58.4	58.2	58.1	57.9

Mean Annual Mass Removal Efficiencies (%) for 0.90-inches of Retention for Zone 4																		
NDCIA CN	Percent DCIA																	
	0-15	20	25	30	35	40	45	50	55	60	65	70	75	80	85	90	95	100
30	96.7	95.7	94.2	92.4	90.3	88.0	85.6	83.1	80.7	78.3	75.9	73.7	71.5	69.4	67.4	65.5	63.7	62.0
35	95.7	94.8	93.5	91.8	89.8	87.6	85.3	82.8	80.4	78.1	75.8	73.6	71.4	69.4	67.4	65.5	63.7	62.0
40	94.4	93.7	92.5	91.0	89.1	87.0	84.8	82.5	80.2	77.9	75.6	73.4	71.3	69.3	67.3	65.5	63.7	62.0
45	92.8	92.4	91.4	90.0	88.3	86.4	84.3	82.0	79.8	77.6	75.4	73.2	71.2	69.2	67.2	65.4	63.6	62.0
50	91.0	90.9	90.1	88.9	87.4	85.6	83.6	81.5	79.3	77.2	75.1	73.0	71.0	69.0	67.2	65.4	63.6	62.0
55	89.0	89.0	88.5	87.6	86.2	84.6	82.7	80.8	78.8	76.7	74.7	72.7	70.8	68.9	67.0	65.3	63.6	62.0
60	86.9	86.9	86.7	86.0	84.8	83.4	81.7	79.9	78.1	76.2	74.3	72.4	70.5	68.7	66.9	65.2	63.5	62.0
65	84.5	84.5	84.5	84.1	83.2	82.0	80.5	78.9	77.2	75.5	73.7	71.9	70.2	68.4	66.7	65.1	63.5	62.0
70	82.1	82.1	82.1	81.8	81.2	80.2	79.0	77.7	76.2	74.6	73.0	71.3	69.7	68.1	66.5	64.9	63.4	62.0
75	79.3	79.3	79.3	79.2	78.8	78.1	77.2	76.1	74.8	73.5	72.0	70.6	69.1	67.7	66.2	64.8	63.3	62.0
80	76.3	76.3	76.3	76.3	76.0	75.6	74.9	74.0	73.1	72.0	70.8	69.6	68.3	67.1	65.8	64.5	63.2	62.0
85	73.0	73.0	73.0	73.0	72.9	72.6	72.1	71.5	70.8	70.0	69.2	68.2	67.3	66.2	65.2	64.1	63.0	62.0
90	69.3	69.3	69.3	69.3	69.3	69.1	68.9	68.6	68.1	67.6	67.1	66.5	65.8	65.1	64.3	63.6	62.8	62.0
95	65.3	65.3	65.3	65.3	65.3	65.3	65.2	65.1	64.9	64.7	64.4	64.2	63.9	63.5	63.2	62.8	62.4	62.0
98	63.4	63.4	63.4	63.3	63.3	63.3	63.2	63.1	63.0	62.9	62.9	62.8	62.6	62.5	62.4	62.2	62.1	62.0

Mean Annual Mass Removal Efficiencies (%) for 1.00-inch of Retention for Zone 4																		
NDCIA CN	Percent DCIA																	
	0-15	20	25	30	35	40	45	50	55	60	65	70	75	80	85	90	95	100
30	97.2	96.4	96.2	93.7	91.9	90.0	87.9	85.7	83.5	81.2	79.0	76.9	74.8	72.8	70.9	69.1	67.3	65.6
35	96.2	95.6	94.5	83.1	91.4	89.6	87.5	85.4	83.2	81.1	78.9	76.8	74.8	72.8	70.9	69.0	67.2	65.6
40	95.1	94.6	93.6	92.4	90.8	89.0	87.1	85.1	82.9	80.8	78.7	76.7	74.7	72.7	70.8	69.0	67.2	65.6
45	93.6	93.4	92.6	91.5	90.0	88.4	86.5	84.6	82.6	80.5	78.5	76.5	74.5	72.6	70.7	68.9	67.2	65.6
50	92.0	91.9	91.4	90.4	89.1	87.6	85.9	84.0	82.1	80.1	78.2	76.2	74.3	72.5	70.6	68.9	67.2	65.6
55	90.2	90.2	89.9	89.1	88.0	86.6	85.1	83.4	81.5	79.7	77.8	75.9	74.1	72.3	70.5	68.8	67.1	65.6
60	88.3	88.3	88.1	87.6	86.7	85.5	84.1	82.5	80.8	79.1	77.3	75.6	73.8	72.1	70.4	68.7	67.1	65.6
65	86.1	86.1	86.1	85.8	85.1	84.1	82.9	81.5	80.0	78.4	76.8	75.1	73.5	71.8	70.2	68.6	67.1	65.6
70	83.9	83.9	83.9	83.7	83.2	82.4	81.4	80.3	78.9	77.5	76.0	74.5	73.0	71.5	70.0	68.5	67.0	65.6
75	81.3	81.3	81.3	81.3	81.0	80.4	79.6	78.7	77.6	76.4	75.1	73.8	72.4	71.0	69.6	68.3	66.9	65.6
80	78.6	78.6	78.6	78.6	78.4	78.1	77.5	76.8	75.9	74.9	73.9	72.8	71.6	70.4	69.2	68.0	66.8	65.6
85	75.6	75.6	75.6	75.6	75.5	75.3	74.9	74.4	73.8	73.1	72.3	71.4	70.5	69.6	68.6	67.6	66.6	65.6
90	72.2	72.2	72.2	72.2	72.2	72.1	71.9	71.6	71.2	70.8	70.3	69.7	69.1	68.5	67.8	67.1	66.3	65.6
95	68.5	68.5	68.5	68.5	68.5	68.5	68.4	68.3	68.2	68.0	67.8	67.6	67.3	67.0	66.7	66.3	65.9	65.6
98	66.8	66.8	66.8	66.7	66.7	66.7	66.6	66.6	66.5	66.4	66.3	66.3	66.1	66.0	65.9	65.8	65.7	65.6

6.10.8 Green roof/Cistern Harvesting Design Curves and Equations:

The green roof/cistern harvesting design curves and equations for Pinellas County (based on Tampa) are shown below:

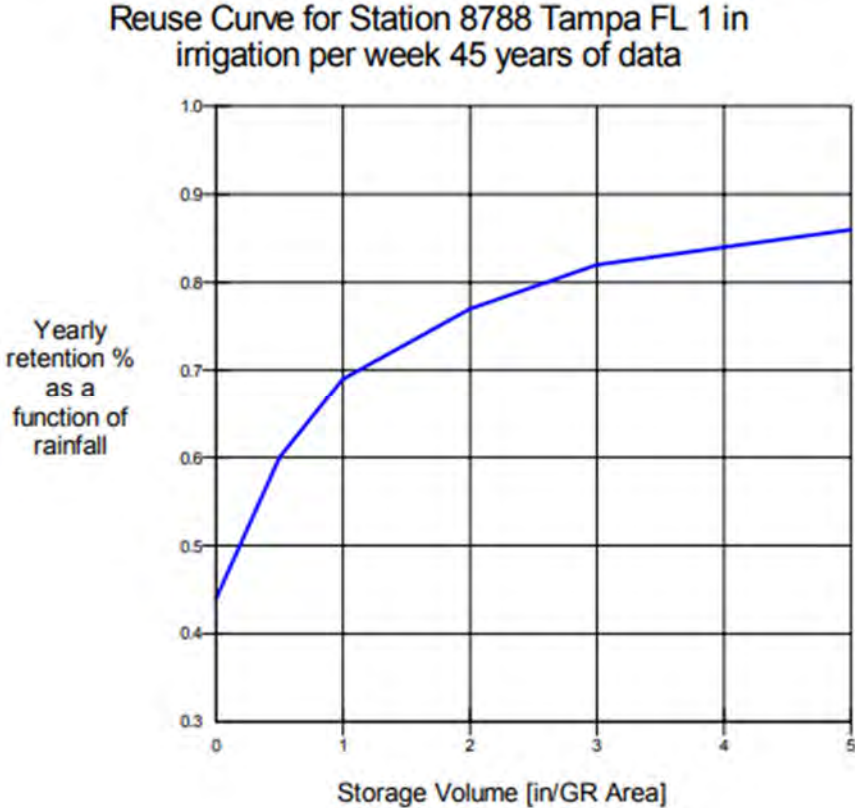
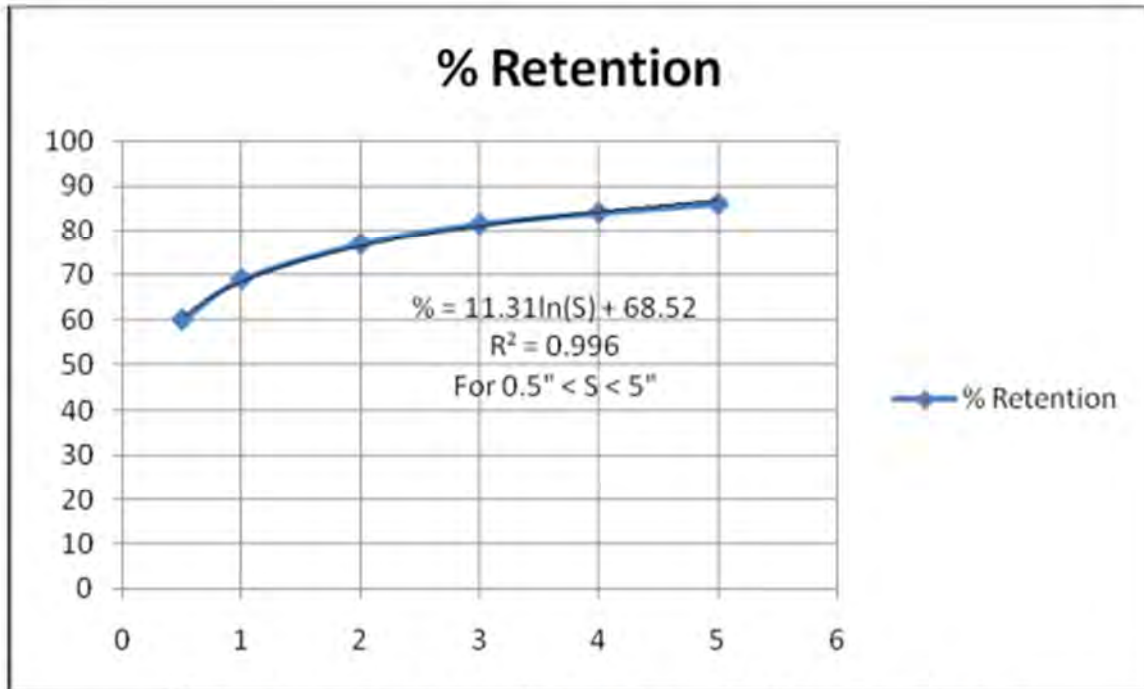

Figure 6.10.1. Green roof Harvesting Design Curve for Tampa Florida Area Using 45 years of data.

Link to source:

http://www.stormwater.ucf.edu/research/hardin_publications/Hardin_Mike_GreenRoofThesis.pdf



At Tampa, percent yearly retention by a greenroof with no cistern is 44%.

Figure 6.10.2. Yearly retention of a green roof including a cistern with storage values between 0.5 inches and 5 inches.

The design curves and equations are based on cistern storage values of between one-half inch (0.5”) and five inches (5.0”). The upper storage limit of five inches was set because there is marginal improvement in pollutant removal above five inches. For example, in St. Petersburg, the yearly retention of a green roof/cistern system is:

% RETENTION = 11.31 Ln(S)+68.52 If cistern storage is 2”, this becomes:

$$\% \text{ RETENTION} = 11.31 \text{ Ln}(2)+68.52 = (11.31 \times 0.69315) + 68.52 = 7.84 + 68.52 = 76.36\%$$

Where:

Ln – Natural Logarithm

This is considerably larger than the 43% retention by the green roof alone.

6.10.9 Removal Efficiency of TP and TN Based on Residence Time:

The relationship between removal efficiency of total phosphorus in wet detention ponds as a function of mean annual residence time is given in Figure 6.10.3. The best-fit relationship for the remaining data was obtained using a second-order relationship involving the natural log of the residence time. The best-fit equation is also provided on Figure 6.10.3. for the relationship between total phosphorus removal efficiency and residence time. This equation provides an extremely good fit between the two variables, with an R² of 0.979. This value indicates that residence time explains approximately 97% of the observed variability in removal efficiencies for total phosphorus in wet detention ponds.

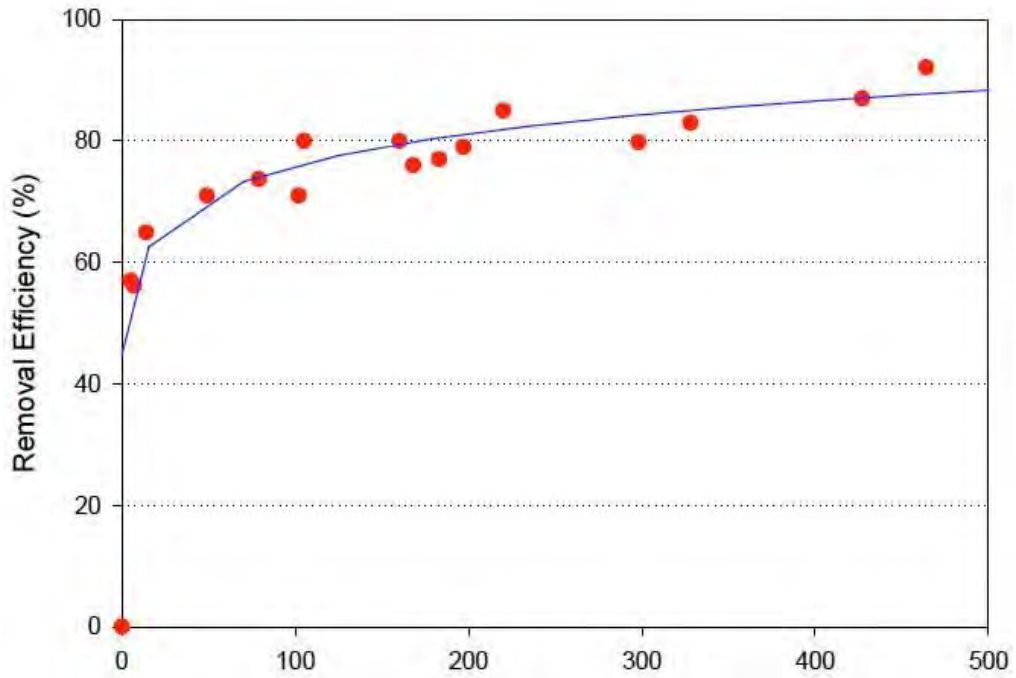

Figure 6.10.3. Removal Efficiency of Total Phosphorus in Wet Detention Ponds as a Function of Residence Time (From *Evaluation of Current Stormwater Design Criteria within the State of Florida*, Final Report

Submitted to the FDEP, June 2007, Harvey Harper and David Baker, Environmental Research and Design, Inc.).

Relationships between mean annual residence time and removal efficiencies for total nitrogen in wet detention ponds for stormwater are illustrated in Figure 6.8.3. The best-fit for the relationship between removal efficiency and residence time for total nitrogen was obtained using a hyperbolic equation for stormwater. The final version of this equation is also summarized on Figure 6.8.3. The R² value of 0.800 suggests that residence time explains approximately 80% of the observed variability in removal efficiencies for total nitrogen in wet detention ponds.

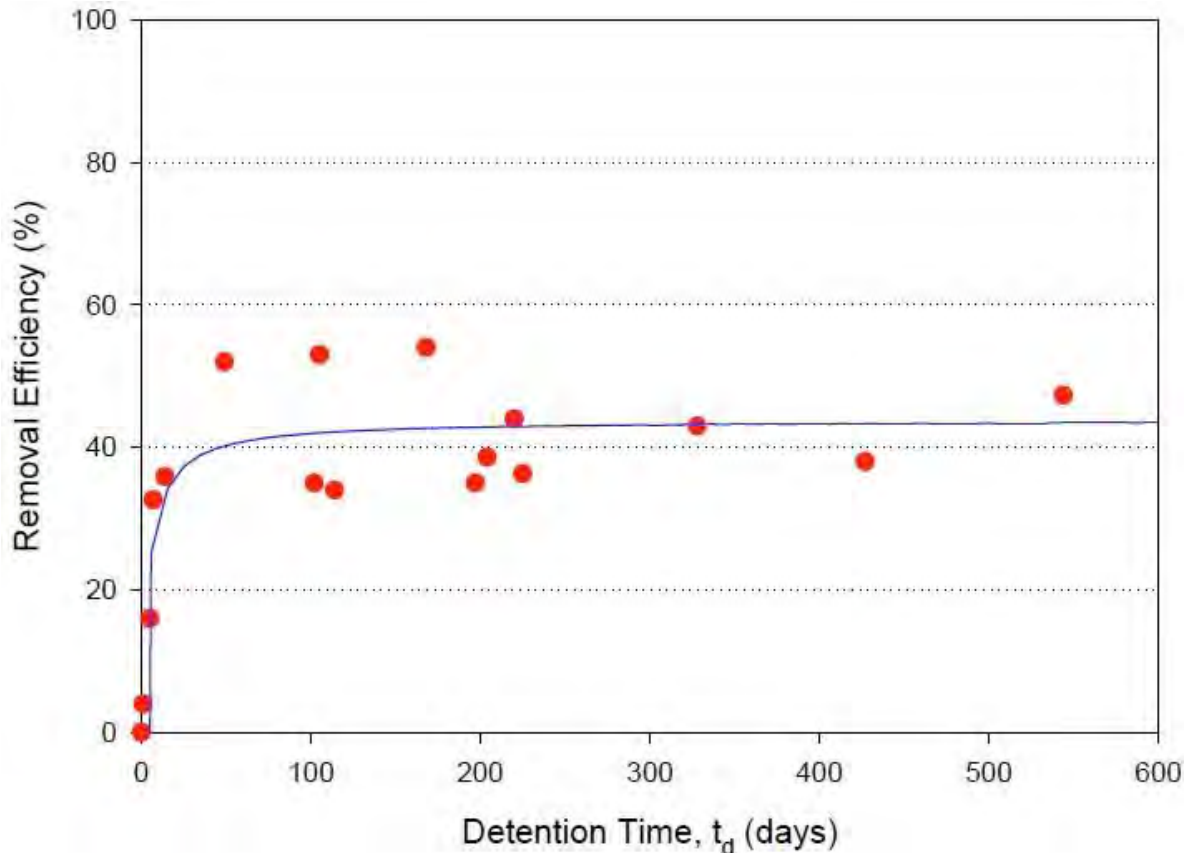

Figure 6.10.4. Removal Efficiency of Total Nitrogen in Wet Detention Ponds as a Function of Residence Time (From Evaluation of Current Stormwater Design Criteria within the State of Florida, Final Report Submitted to the FDEP, June 2007, Harvey Harper and David Baker, Environmental Research and Design, Inc.).

Page intended to be blank



PINELLAS COUNTY
STORMWATER MANUAL
APPENDICES



Appendix A – Methodologies

The methodologies in this Appendix are intended to aid applicants in designing stormwater treatment systems to meet the design and performance criteria of this Manual. These methodologies are by no means the only acceptable method for designing stormwater management systems. Applicants proposing to use alternative methodologies are encouraged to consult with County or SWFWMD staff in a pre-application conference.

A.1. Methodologies, Recovery Analysis, and Soil Testing for Retention Systems

A.1.1. Description

“Retention systems” are a family of Best Management Practices (BMPs) designed to store a defined quantity of runoff, allowing it to percolate through vegetation and permeable soils into the shallow groundwater aquifer, or re-enter the atmosphere through evaporation, and evapotranspiration. Stormwater retention works best using a variety of BMPs throughout the project site. Examples of common retention BMPs include (but are not limited to):

- Retention basins, which are constructed or natural depressional areas where the basin bottom is graded as flat as possible, and turf, seed & mulch (or other equivalent materials) are established to promote infiltration and stabilize the basin slopes. These retention systems are discussed in greater detail in **Section 6.1.** of this *Manual*.
- Underground Exfiltration Trenches that are discussed in greater detail in **Section 6.2.** of this *Manual*.
- Underground Retention Systems that are discussed in greater detail in **Section 6.3.** of this *Manual*.
- Vegetated treatment swales with or without swale blocks that are discussed in greater detail in **Section 6.4.** of this *Manual*.
- Vegetated Natural Buffers that are discussed in greater detail in **Section 6.5.** of this *Manual*.
- Pervious pavement with perimeter edge constraints that are discussed in greater detail in **Section 6.6.** of this *Manual*.

Each of the BMPs listed above have their individual advantages and disadvantages. Cross-sectional diagrams for each of these BMPs are provided in their respective sections of the *Manual* as noted above. It is not the intent of this section to cover all potential designs. Professional judgment must be used in the design and review of proposed retention BMPs.

The soil's saturated hydraulic conductivity, depth to the Seasonal High Ground Water Table (SHGWT) and depth to the confining unit (i.e., clay, hardpan, etc.) must be such that the retention system can percolate the Required Treatment Volume (RTV) within a specified time following a storm event. After drawdown has been completed, retention BMPs do not hold any water, thus the systems are normally “dry.” Unlike detention BMPs, the RTV for retention systems is not discharged to surface waters.

Retention systems provide excellent removal of most stormwater pollutants. Substantial amounts of suspended solids, oxygen demanding materials, heavy metals, bacteria, some varieties of pesticides and nutrients such as phosphorus may be removed as runoff percolates through the soil profile.

Besides pollution control, retention systems can be used to promote the recharge of ground water, to prevent saltwater intrusion in coastal areas and maintain ground water levels in aquifer recharge areas. Retention systems can also be used to help meet the runoff volume criteria for systems that discharge to closed basins or land-locked lakes. However, the use of retention systems is not appropriate if they contribute to a violation of Minimum Flows or Levels in the receiving waters, or if they adversely impact wetlands by hydrologic alteration.

A.1.2. Required Treatment Volume (RTV)

The RTV necessary to achieve the required treatment efficiency will be routed to the retention BMP and percolated into the ground. The required level of nutrient removal is specified in Section 5.1.1 of this Manual. The RTV and other design criteria for each type of retention BMP is specified in the section of the Manual for that particular BMP.

A.1.3. Recovery Time of the RTV

All retention systems must provide the capacity for the RTV of stormwater to recover to the bottom of the system within 72 hours following a storm event, assuming an average Antecedent Runoff Condition (ARC II). The locations of the RTV (and its corresponding bottom) are shown in the supporting graphic figures of the various BMP Sections noted above. A safety factor of two (2.0) must be used in the recovery analysis of the RTV. Two possible ways to apply this safety factor are:

- (a) Reducing the design saturated hydraulic conductivity rates by half; or
- (b) Designing for the required RTV drawdown to occur within half of the required drawdown time.

The safety factor of two (2.0) is based on the high probability of:

- Soil compaction during clearing and grubbing operations,
- Improper construction techniques that result in additional soil compaction under the retention BMP,
- Inadequate long-term maintenance of the retention BMP, and
- Geologic variations and uncertainties in obtaining the soil test parameters for the recovery/mounding analysis (noted in subsequent sections below). These variations and uncertainties are especially suspect for larger retention BMPs.

In retention systems, the RTV recovers (is drawn down or dissipated) by natural soil infiltration into the groundwater table, evaporation, or evapotranspiration. The opposite is true for underdrain effluent detention systems, which rely on artificial recovery methods such as underground perforated stormwater pipes. Areas with seasonal high groundwater tables (SHGWT) close to the surface should avoid reliance on retention and infiltration-based BMPs. Please make sure to follow the recommendations of each BMP for limitations on clearances to SHGWT.

Antecedent Runoff Condition (ARC), formally known as Antecedent Moisture Condition (AMC), refers to the amount of moisture and storage in the soil profile prior to a storm event. Antecedent soil moisture is an indicator of wetness and availability of soil to infiltrate water. The ARC can vary from dry to saturated, depending on the amount of rainfall received prior to a given point in time. Therefore, "average ARC" (ARC II) means the soil is neither dry nor saturated, but at an average moisture condition at the beginning of a storm event when calculating recovery time for retention systems.

A.1.4. Infiltration Processes

When stormwater runoff enters the retention BMP, standing water begins to infiltrate. This water percolates into the soil in two distinct stages, either vertically (Stage One) through the BMP bottom (unsaturated flow), or horizontally (Stage Two) through the side slopes (saturated flow). One flow direction or the other will predominate depending (primarily) on:

- The depths to the water table and confining unit (i.e., clay or hardpan) below the bottom of the retention BMP, and
- The soil's saturated hydraulic conductivity.

The following paragraph briefly describes the two stages of infiltration, and subsequent subsections present accepted methodologies for calculating infiltration rates and recovery times for unsaturated vertical (Stage One) and saturated horizontal (Stage Two) flow.

Initially, the subsurface conditions are assumed to be:

- The depth to the initial water table below the bottom of the BMP.
- Unsaturated soils above the water table.

When the water begins to infiltrate, it is driven downward as unsaturated flow by the combined forces of gravity and capillary action. Once the unsaturated soil below the BMP becomes saturated (fills the voids in the soil), the water table begins to "mound" (refer to **Figure A.1.1., Ground Water Mounding Beneath a Retention System, below.**

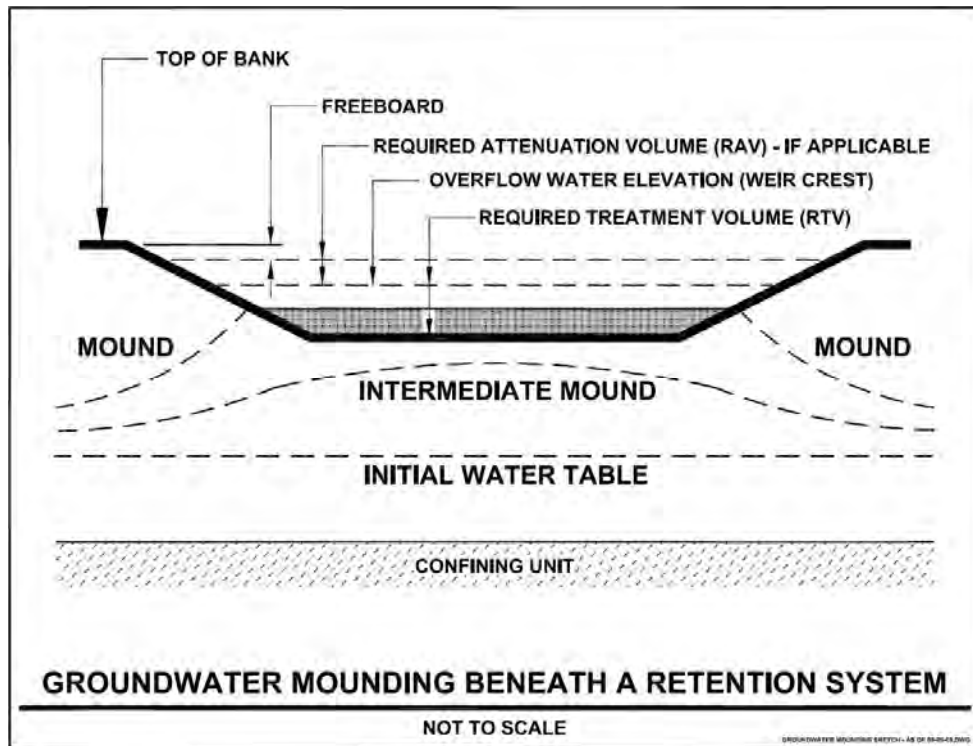

A.1.5. Accepted Methodologies for Determining Retention BMP Recovery

A. Acceptable methodologies for calculating retention BMP recovery are presented below in **Table A.1. 1**

Vertical Unsaturated Flow	Horizontal Saturated Flow
Green and Ampt Equation	Simplified Analytical Method
Hantush Equation	PONDFLOW
Horton Equation	Modified MODRET
Darcy Equation	
Holton Equation	

Several of these methodologies are available in commercial software products. The Agencies can neither endorse any software program nor certify software results.

B. Additional requirements for calculating retention BMP recovery

Unless the normal Seasonal High Ground Water Table (SHGWT) is greater than or equal to two feet below the bottom of the BMP system, unsaturated vertical flow prior to saturated horizontal mounding will be conservatively ignored in the recovery analyses. This is not an unrealistic assumption since the height of the capillary fringe in fine sands is on the order of six inches, and a partially mounded water table condition may be remnant from a previous storm event.

A.1.6. Requirements, Guidance and Recommendations for Manual Computations or Computer Simulations

Computer-based ground water flow models are routinely used by practicing engineers and hydrogeologists to predict the time for percolation of the Required Treatment Volume (RTV). The reliability of the output of these models cannot exceed the reliability of the input data. **Input data assessment is probably the most neglected single task in the ground water modeling process.** The accuracy of computer simulations hinges on the quality and completeness of the input data.

The computer models listed in the previous section require input values of the retention BMP dimensions, retained stormwater runoff volume (the RTV) and the following set of aquifer parameters:

- Thickness or elevation of base of mobilized (or effective) aquifer
- Weighted horizontal saturated hydraulic conductivity of mobilized aquifer
- Fillable porosity of mobilized aquifer
- Ambient water table elevation which, for design purposes, is usually the normal Seasonal High Ground Water Table (SHGWT)

Calculated recovery times are most sensitive to the input value for the aquifer's **saturated hydraulic conductivity**.

A. **Determination of Aquifer Thickness**

Standard Penetration Test (SPT) borings are recommended for definition of the aquifer thickness, especially where the ground water table is deep. This type of boring provides a continuous measure of the relative density/consistency of the soil (as manifested by the SPT "N" values). A relative density-texture (-200 value) better identifies an aquitard or confining unit.

Manual "bucket" auger borings (when supplemented with classification testing) can also be used to define the thickness of the uppermost aquifer (i.e., the depth to the confining unit), especially for small retention ponds and swales.

Definition of SPT "N" Values

The Standard Penetration Test (SPT) consists of driving a split-barrel sampling "spoon" or sampler a distance of 30 cm (12 in) after first "seating" the sampler 15 cm (6 in) by dropping a 63.5 kg (140 lb) hammer from a height of 76 cm (30 in). In field practice, the sampler is driven to a designated depth through a borehole using a long rod, and the hammer strikes the top end of the rod above the ground surface. The operator counts the number of blows that it takes to advance the sampler each of three 15 cm (6 in) increments. When the sampler has penetrated 45 cm (18 in) into the soil at the bottom of the borehole, the operator adds the number of blows for the second and third increments. This combined number is the result of the SPT and is called the "blow count" and is customarily designated as "N" or the "N value". It directly reflects the penetration resistance of the ground or the soil under investigation.

Definition of a Confining Unit

The confining unit is a hydraulically restrictive layer (i.e., a clay layer, hardpan, etc.). For many recovery / mounding simulations, the confining unit can be considered as a restrictive layer that has a saturated hydraulic conductivity an order of magnitude (10 times) less than the soil strata (sands) above. In some cases, the "Physical & Chemical Properties table" [within the older NRCS soil surveys (legacy documents)] identifies these soil strata as having a vertical hydraulic conductivity (permeability by NRCS) of 0.06 to 0.6 inches per hour, with the soil above having a permeability of 0.6 to 6.0 inches per hour.

Another method to supplement the identification of a confining unit is to carefully review the SPT boring logs for increases in the SPT "N" values. SPT "N" values (blow counts) alone should be avoided as the primary method to identify a confining unit.

Definition of a Hardpan

A hardpan is a hardened or cemented soil horizon or layer. The soil material is sandy, loamy, or clayey and is cemented by iron oxide, silica, calcium carbonate or other substances.

Definition of a Spodic Horizon

Florida's pine Flatwoods areas typically have a spodic horizon into which organic matter has accumulated. In many cases, this spodic horizon is locally called a hardpan. Pine Flatwoods are the most predominant natural landscape in Florida, comprising approximately 8.4 million acres.

B. Estimated Normal Seasonal High Ground Water Table (SHGWT)

In estimating the normal SHGWT, the contemporaneous measurements of the water table are adjusted upward or downward taking into consideration numerous factors, including:

- Antecedent rainfall
- Soils on the project site.
- Examination of the soil profile, including redoximorphic features, SPT "N" values, depth to "hardpan" or other impermeable horizons (such as clayey fine sands and clays), etc.
- Consistency of water levels with adjacent surface water bodies and knowledge of typical hydraulic gradients (water table slopes).
- Vegetative indicators
- Effects of existing and future development, including stormwater ditches, modification of land cover, subsurface drains, irrigation, septic tank drainfields, etc.
- Hydrogeologic setting, including the potentiometric surface of Floridian aquifer and degree of connection between the water table aquifer and the Floridian aquifer.
- Soil Morphological Features

In general, the measurement of the depth to the ground water table is less accurate in SPT borings when drilling fluids are used to maintain an open borehole. Therefore, when SPT borings are drilled, it may be necessary to drill an auger boring adjacent to the SPT to obtain a more precise stabilized water table reading. In poorly drained soils (HSG "B/D" and "D"), the auger boring should be left open, preferably using Piezometer pipe, long enough (at least 24 hours) for the water table to stabilize in the open hole.

If there is ground water relief within the footprint of the pond, the average ground water contour should be considered representative of the pond.

C. Estimation of Horizontal Hydraulic Conductivity of Aquifer

The following hydraulic conductivity tests are required for retention BMPs:

- Laboratory hydraulic conductivity test on an undisturbed sample (constant or falling head)
- Uncased or fully screened auger hole
- Cased hole with uncased or screened extension with the base of the extension at least one (1) foot above the confining layer
- Pump test, when accuracy is important and hydrostratigraphy is conducive to such a test method.
- Slug Test(s)

Of the above methods, the most cost-effective is the laboratory hydraulic conductivity test on an undisturbed horizontal sample. However, it becomes difficult and expensive to obtain undisturbed hydraulic conductivity tube samples under the water table or at depths greater than 5 feet below ground surface.

Pump tests are the most expensive of the recommended hydraulic conductivity test methods. Therefore, it is recommended that pump tests be used in cases where the effective aquifer is relatively thick (greater than 10 feet) and where the environmental, performance, or size implications of the system justifies the extra cost of such a test.

When the aquifer is layered, it is possible to combine several layers and consider the resulting medium as homogenous. If the flow through such layers is mainly horizontal, the arithmetic mean of the hydraulic conductivity estimates of the individual layers should be used to obtain determine the effective hydraulic conductivity (K_e) of the mobilized aquifer as follows:

$$K_{xxx} = \frac{\sum K_{xxx} d_x}{\sum d_x}$$

where,

K_{xe} is the effective hydraulic conductivity in the x direction
 K_{xi} is the hydraulic conductivity of a layer i in the x direction
 d_i is the thickness of layer i

Note that these layers are above the restrictive layer of hardpan or clayey material. Since the most permeable layer will control the value of the weighted hydraulic conductivity, it is important that the hydraulic conductivity of this layer be tested.

For design purposes of all retention BMPs, a saturated hydraulic conductivity value over 40 feet per day will not be allowed for fine-grained sands, and 60 feet per day for medium-grained sands.

If the mobilized aquifer is thick with substantial saturated and unsaturated zones, it is worthwhile to consider performing a laboratory permeameter test on an undisturbed sample from the upper unsaturated profile and also performing one of the in-situ tests to characterize the saturated portion of the aquifer.

D. Estimation of Fillable Porosity

In Florida, the receiving aquifer system for retention BMPs predominantly comprises poorly graded (i.e., relatively uniform particle size) fine sands. In these materials, the water content decreases rather abruptly with the distance above the water table and thus has a well-defined capillary fringe.

Unlike the hydraulic conductivity parameter, the fillable porosity of the poorly graded fine sand aquifers in Florida are in a narrow range (20 to 30%) and can be estimated with much more reliability.

For fine sand aquifers, it is therefore recommended that a fillable porosity in the range of 20% to 30% be used in infiltration calculations.

The higher values of fillable porosity will apply to the well- to excessively-drained, hydrologic group "A" fine sands, which are generally deep, contain less than 5% by weight passing the U.S. No. 200 (0.074 mm) sieve, and have a natural moisture content of less than 5%.

No specific field or laboratory testing requirement is recommended, unless there is a reason to obtain a more precise estimate of fillable porosity. In such a case, it is recommended that the following equation be used to compute the fillable porosity:

$$\text{Fillable porosity} = (0.9 N) - (w \gamma_d / \gamma_w)$$

Where N = total porosity

W = natural moisture content (as a fraction)

γ_d = dry unit weight of soil

γ_w = unit weight of water

E. Maximum depth to the SHGWT and confining unit for the required recovery/mounding analysis

The maximum depths that will be allowed to the SHGWT and the top of the confining unit will be the higher values of:

- The field confirmed SHGWT or confining unit depth(s) from the boring(s) / test pit(s), or
- The termination depth of the field boring / test pit if a SHGWT or confining unit is not encountered.

F. Requirements and recommendations regarding constructed breaches in the confining unit

- A detention or retention BMP will not be excavated to a depth that breaches an aquitard such that it would allow for lesser quality water to pass, either way, between the two systems. In those geographical areas where there is not an aquitard present, the depth of the pond will not be

excavated to within two feet of the underlying limestone which is part of a drinking water aquifer.

- Standard Penetration Test (SPT) borings will be required for any type of deep BMP that has the potential for breaching an aquitard.

A.1.7. Requirements, Guidance and Recommendations for BMP Soil Testing

One of the most important steps in the evaluation of a stormwater BMPs is determining which test methods and how many tests should be conducted per system. Typically, soil borings and saturated hydraulic conductivity measurements are conducted for each BMP. Soil testing requirements listed in this Section of the Manual represent the minimum. It is the responsibility of the registered professional to determine if additional soil borings and hydraulic saturated conductivity tests beyond the minimum are needed due to site conditions. Additional tests will be required if initial testing results deviate to such an extent that they do not provide reasonable assurance that the site conditions are represented by the data provided.

Standard Penetration Test (SPT) borings or auger borings are commonly used to determine the subsurface soil and ground water table conditions. Test borings provide a reasonable soil profile and an estimate of the relative density of the soils. However, measurement of the ground water table depth from SPT borings is usually less accurate than from auger borings. Measurement of hydraulic conductivity requires more specialized tests as described in the previous section.

To measure saturated infiltration, several methods are employed in both the laboratory and in the field. Generally, laboratory tests require collection of an “undisturbed” sample of soil, in either the vertical or horizontal condition, often by means of a Shelby tube. Measurements are performed on the sample via a constant head or falling head condition in a laboratory permeameter. Other methods that involve “remolding” of the soil sample are generally not as accurate as the undisturbed sample methodology.

Field methods for measuring saturated hydraulic conductivity include auger hole tests, piezometer tests, and pumping tests. Although these tests can be more time consuming, they test a larger volume of soil and generally provide more representative results.

A. Restrictions on the use of double ring infiltrometer tests

The double-ring infiltrometer field test is used for estimating in-situ infiltration rates. If used, these tests must be conducted at the depth of the proposed pond bottom and will only be used to obtain the initial “unsaturated” hydraulic conductivity. Once the ground water mound rises to the BMP bottom, the results of a double-ring infiltrometer test are not valid. The rate obtained using the double ring infiltrometer is divided by two to obtain the infiltration rate during flowing conditions (e.g. swales).

B. Requirements for soil testing

Information related to soils must include the following:

- Soils test results will be included as part of a supporting soils/geotechnical report of a project's ERP application. This report must be certified by the appropriate Florida registered professional.
- For all soil borings that are used to estimate the depth to the Seasonal High Ground Water Table (SHGWT), the soil colors will be denoted by both their English common name and their corresponding Munsell color notation (i.e., light yellowish brown – 10YR 6/4).

- Soil test locations will be located on the construction drawings, or as an option, the permit review drawings that are submitted as part of the ERP application to the Agency. The horizontal locations of the soil borings/tests will be placed on the appropriate plan sheet(s), and vertical locations of the soil borings/tests will be placed on the appropriate retention BMP cross-section(s). The designation number of each test on the plan or cross-section sheets will correspond to the same test number in the supporting soils/geotechnical report (i.e., SPT #1, Auger boring #2, hydraulic conductivity test #3, etc.).
- The vertical datum of the soil tests results will be converted to the same datum of the plan sheets and retention BMP cross-sections. For instance, the geo-technical consultant's certified report shows the top of the confining unit in SPT #1 as six feet Below Land Surface (BLS). The design consultant of record must then convert this BLS data to the vertical datum of the cross-section sheet for the BMP (NGVD29, NAVD88, or another vertical datum specified by the appropriate regulatory agency).

The location and number of soil borings and saturated hydraulic conductivity tests performed are usually based on the various site characteristics and requires considerable professional judgment and experience in the decision process. At a minimum, the following number of tests will be required for each proposed BMP unless the specific BMP design criteria do not require soil testing:

The minimum number of required Soil Borings - The greater of the following two criteria:

- One for each BMP, drilled to at least ten feet below the bottom of the proposed BMP system. For instance, if a BMP has a pond bottom five feet below existing land surface, the minimum boring depth will be 15 feet below existing land surface.
- For BMPs larger than 0.25-acre, retention systems within Sensitive Karst Areas, complex hydrogeology, appreciable topographic relief under the retention BMP, or areas that been filled or otherwise disturbed to change the site's soil characteristics such as in certain urban areas or reclaimed mined lands:

$$B = 1 + \sqrt{2A} + \frac{L}{2\pi W}$$

Where:

B = number of required borings under each retention BMP, drilled to at least ten feet below the bottom of the proposed BMP system. For instance, if a retention pond has a pond bottom 5 feet below existing land surface, the minimum boring depth will be 15 feet below existing land surface (rounded up or down to the next whole number).

A = average BMP area in acres (measured at the control elevation)

L = length of the BMP in feet (length is the longer of the dimensions)

W = width of the BMP, in feet

π = PI, approximately 3.14

- For swales, a minimum of one boring will be taken for each 500 linear feet or for each soil type that the swale will be built on.

For the recovery / mounding analysis, SPT borings should be continuously sampled at least two feet into the top of the hydraulically restrictive layer. If a restrictive layer is not encountered, the boring will

be extended to at least ten feet below the bottom of the pond / system. As a minimum, the depth of the exploratory borings should extend to the base elevation of the aquifer assumed in analysis, unless nearby deeper borings or well logs are available.

Minimum number of required Saturated Hydraulic Conductivity tests - At a minimum, the following number of tests will be required for each proposed BMP unless the specific BMP design criteria do not require saturated hydraulic conductivity testing. The greater of the following two criteria:

- One for each BMP, taken no shallower than the proposed bottom of the BMP system, or deeper if determined by the design professional to be needed for the particular site conditions. However, if the system will be built on excessively drained soils, the applicant may propose a lesser number of tests based on plans, test results, calculations or other information, that the number of tests is appropriate for the specific site conditions.
- For BMPs larger than 0.25-acre, retention systems within Sensitive Karst Areas, complex hydrogeology, appreciable topographic relief under the retention BMP, or urbanized (or reclaimed mining) areas that have undergone previous soil disturbance:

$$P = 1 + (B / 4)$$

Where:

P = number of saturated hydraulic conductivity tests for each retention BMP, taken no shallower than the proposed bottom of the retention system, or deeper if determined by the design professional to be needed for the particular site conditions (rounded up or down to the next whole number). However, if the system will be built on excessively drained soils, the applicant may propose a lesser number of tests based on plans, test results, calculations or other information, that the number of tests is appropriate for the specific site conditions.

B = number of required borings (from above).

- For wet detention, stormwater harvesting, or underdrain BMPs that have the potential for impacting adjacent wetlands or potable water supply wells, the hydraulic conductivity tests will be required between the location of the BMP and the adjacent wetlands or well.

Appendix B – Rainfall Distribution

SOUTHWEST FLORIDA WATER MANAGEMENT DISTRICT

Figure D-1
Twenty-Four-Hour Two-Year Return Period
Rainfall Map

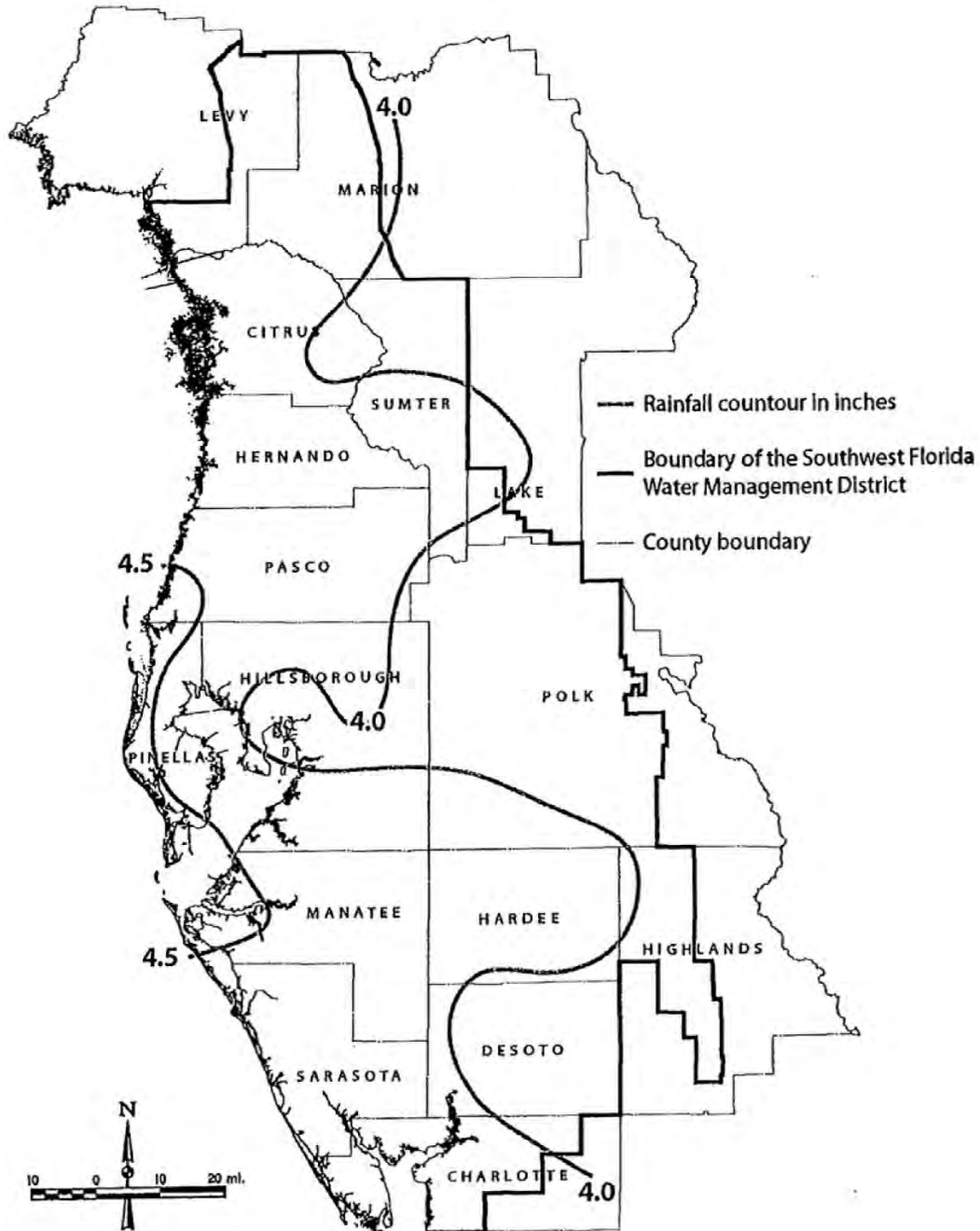

SOUTHWEST FLORIDA WATER MANAGEMENT DISTRICT

Figure D-2
Twenty-Four-Hour Mean Annual Return Period (2.33 years)
Rainfall Map

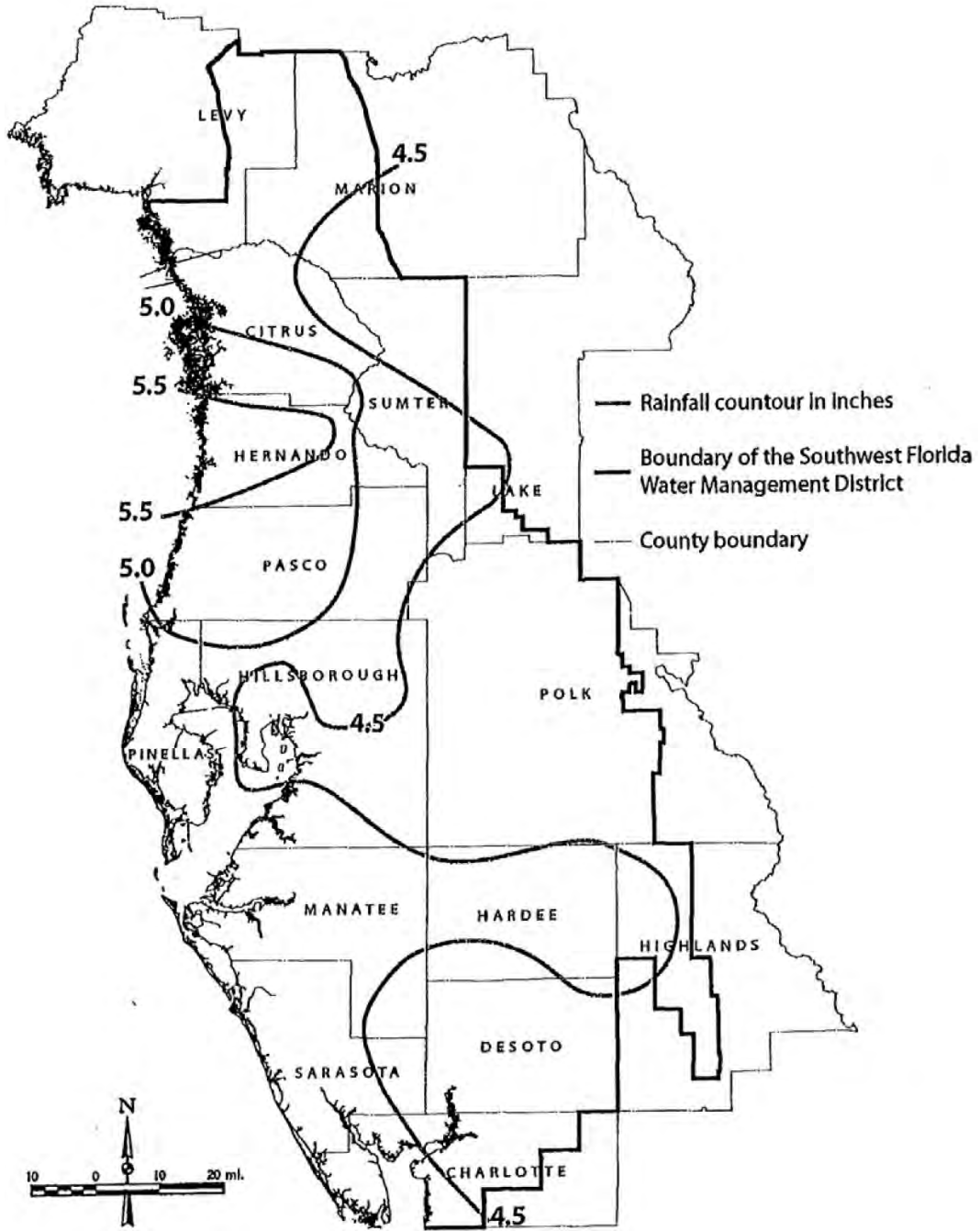

SOUTHWEST FLORIDA WATER MANAGEMENT DISTRICT

Figure D-3
Twenty-Four-Hour Five-Year Return Period
Rainfall Map

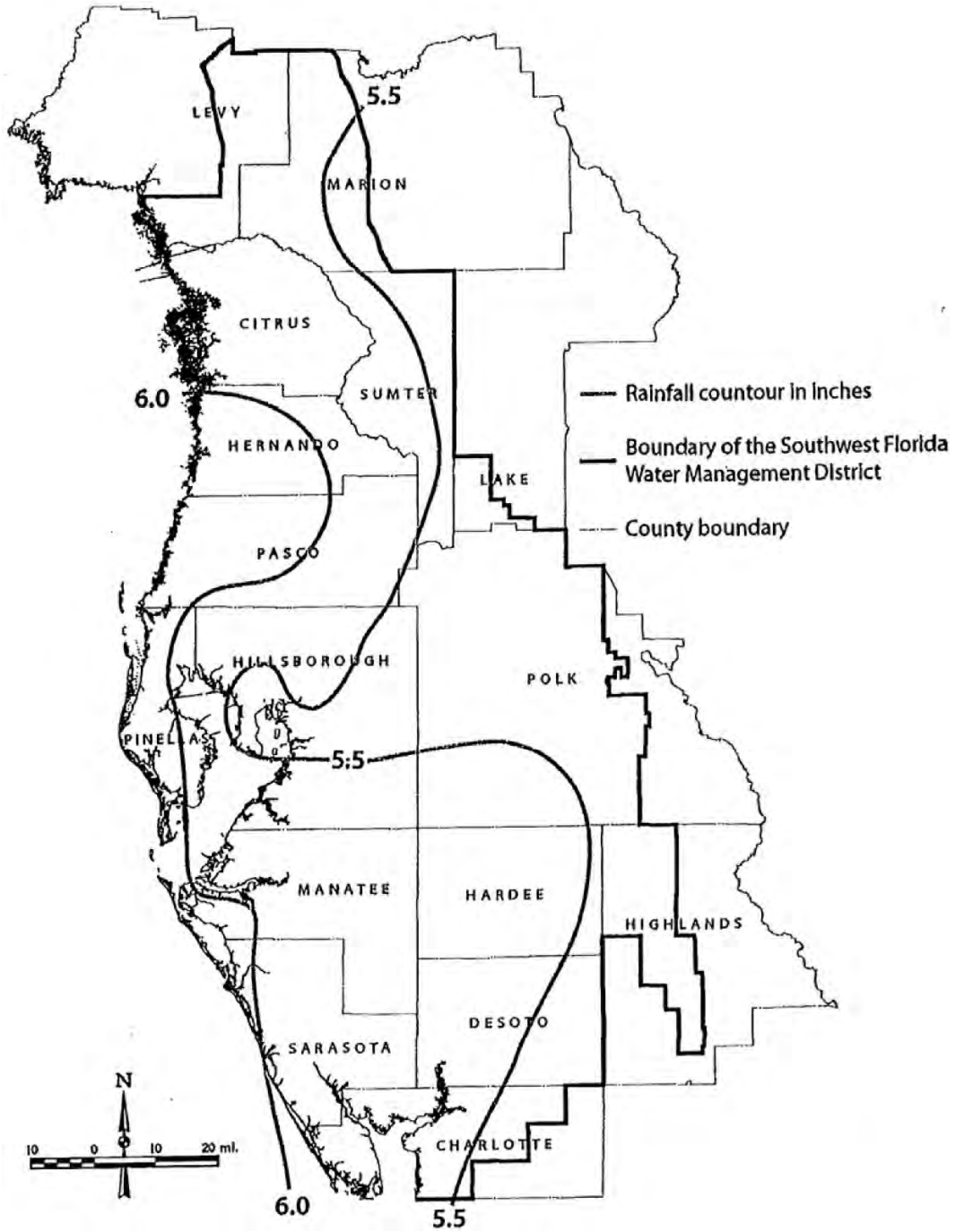

SOUTHWEST FLORIDA WATER MANAGEMENT DISTRICT

Figure D-4
Twenty-Four-Hour Ten-Year Return Period
Rainfall Map

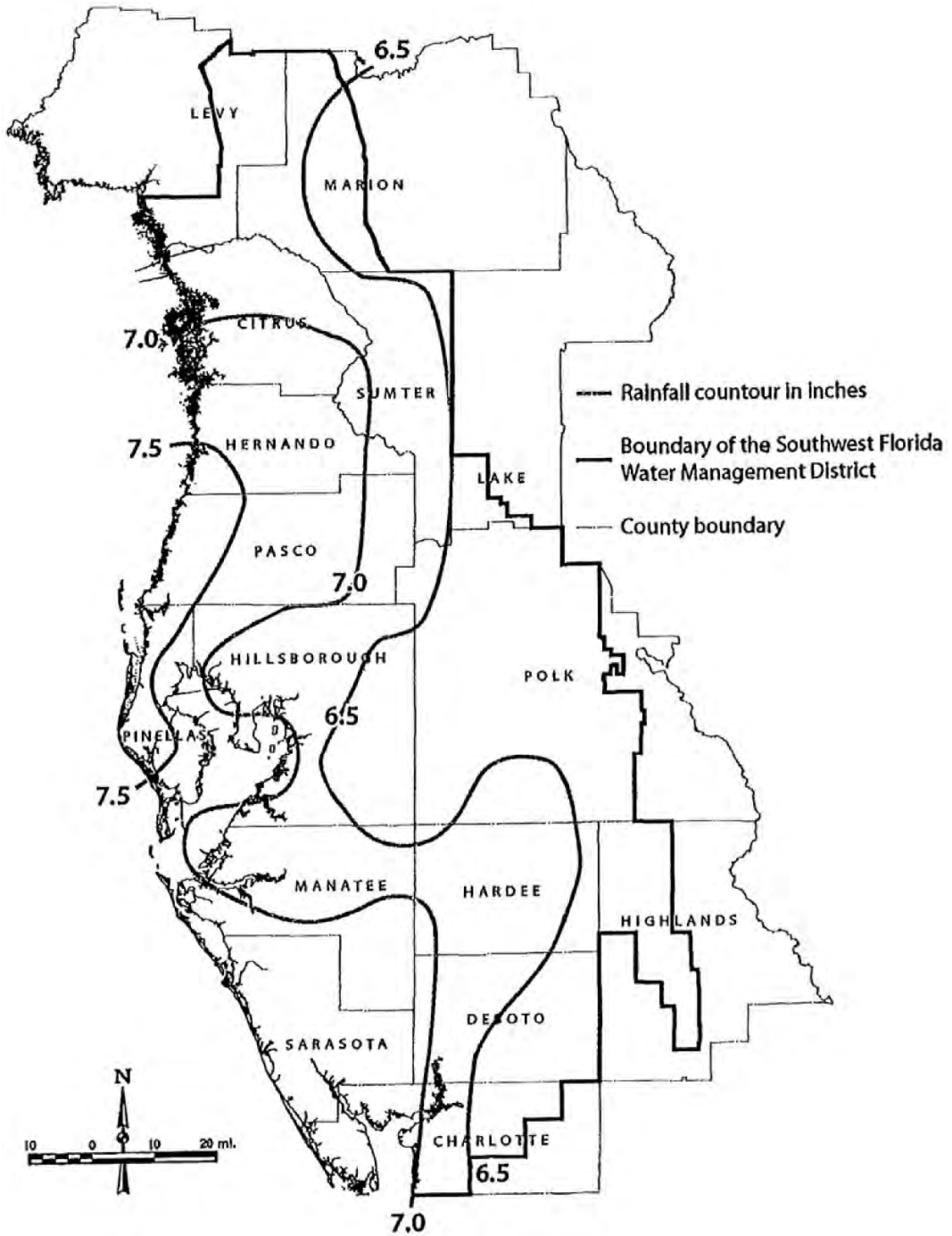

SOUTHWEST FLORIDA WATER MANAGEMENT DISTRICT

Figure D-5
Twenty-Four-Hour Twenty-Five-Year Return Period
Rainfall Map

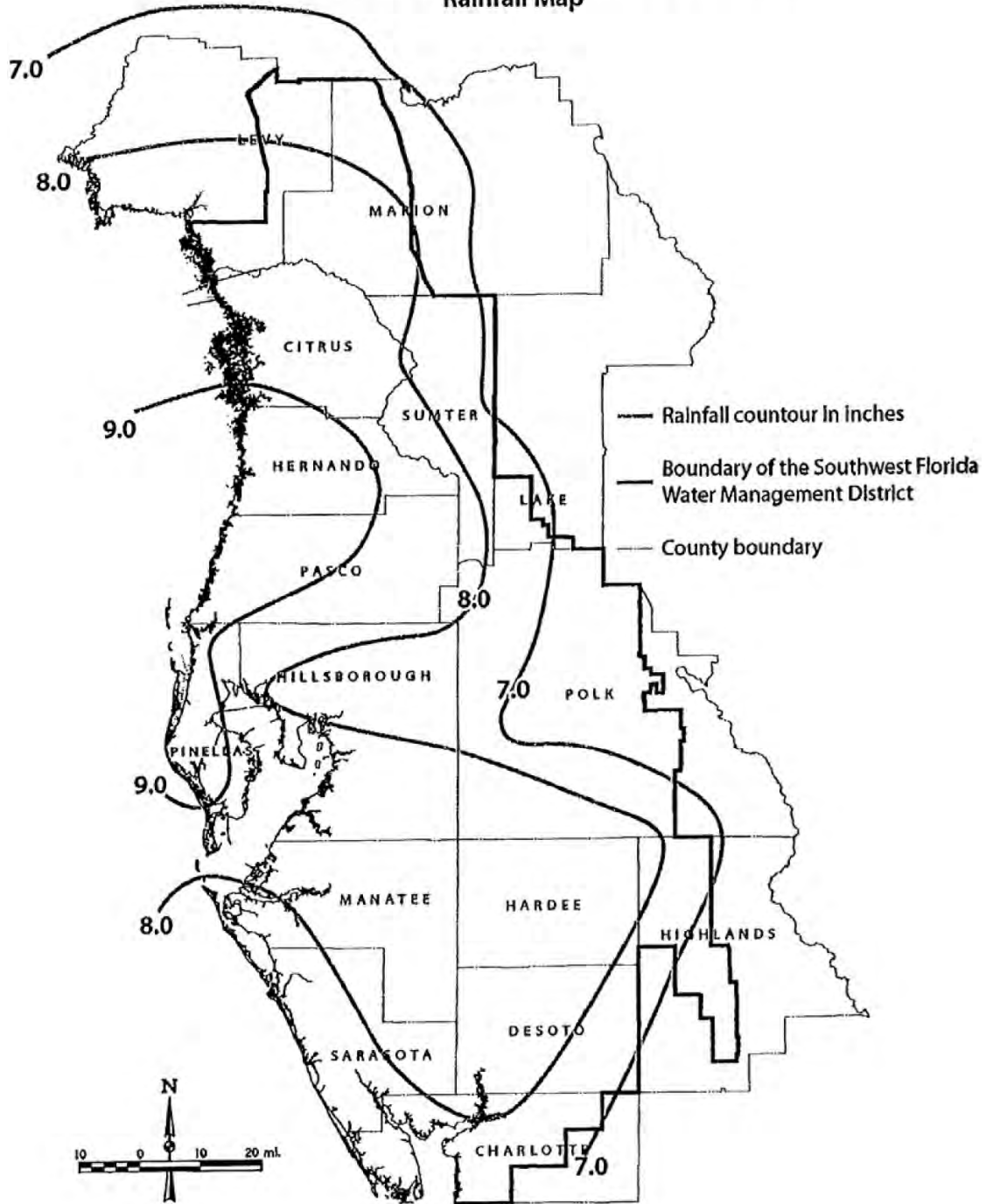

SOUTHWEST FLORIDA WATER MANAGEMENT DISTRICT

Figure D-6
Twenty-Four-Hour Fifty-Year Return Period
Rainfall Map

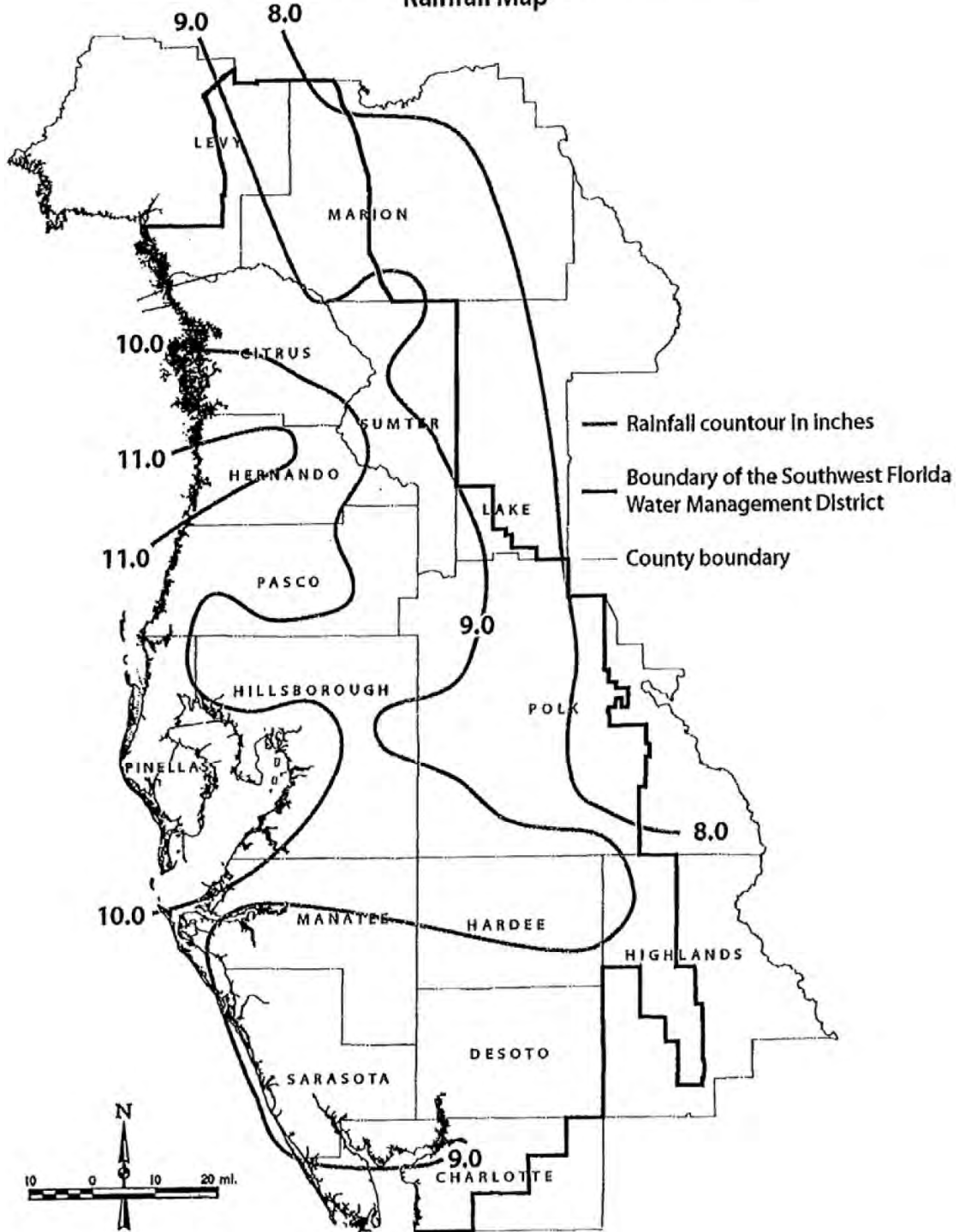

SOUTHWEST FLORIDA WATER MANAGEMENT DISTRICT

Figure D-7
Twenty-Four-Hour One-Hundred-Year Return Period
Rainfall Map

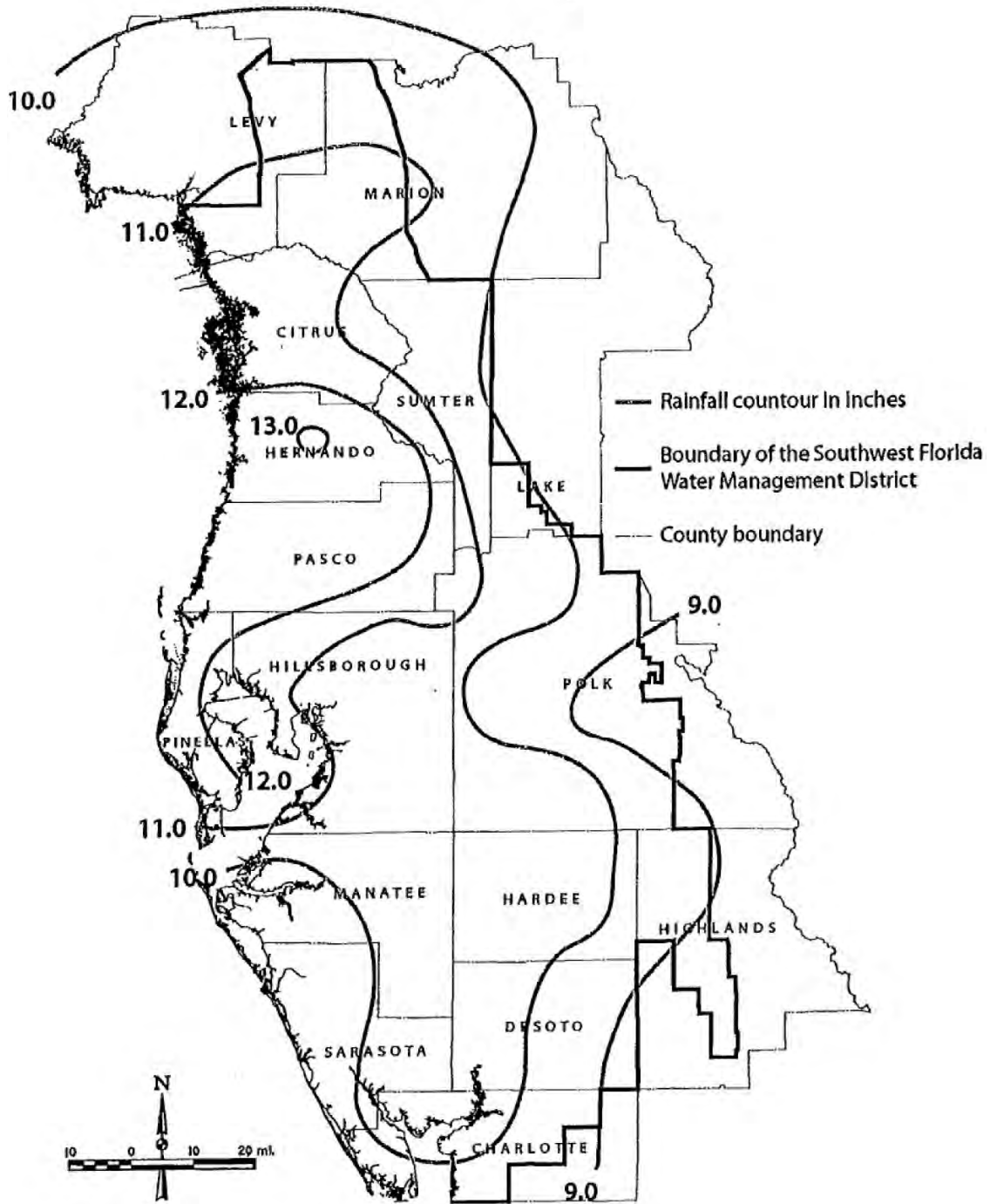

Table B-1. Type II Florida Modified Rainfall Distribution

TABLE D-1
RAINFALL RATIOS (ACCUMULATED 24-HOUR TOTAL)
SCS TYPE II FL. MODIFIED

<u>TIME (HR)</u>	
0.0	.000
0.5	.006
1.0	.012
1.5	.019
2.0	.025
2.5	.032
3.0	.039
3.5	.047
4.0	.054
4.5	.062
5.0	.071
5.5	.080
6.0	.089
6.5	.099
7.0	.110
7.5	.122
8.0	.134
8.5	.148
9.0	.164
9.5	.181
10.0	.201
10.5	.226
11.0	.258
11.5	.308
12.0	.607
12.5	.719
13.0	.757
13.5	.785
14.0	.807
14.5	.826
15.0	.842
15.5	.857
16.0	.870
16.5	.882
17.0	.893
17.5	.904
18.0	.913
18.5	.923
19.0	.931
19.5	.940
20.0	.948
20.5	.955
21.0	.962
21.5	.969
22.0	.976
22.5	.983
23.0	.989
23.5	.995
24.0	1.000

D-13

Appendix C – Stormwater Retrofits

C.1. Description

Since much of Pinellas County was developed before the implementation of Florida's Stormwater Treatment Rule in 1982, a major challenge facing the county's residents is how to "retrofit" the county's existing "drainage systems" to provide stormwater treatment. An urban stormwater retrofit is a project that adds treatment to an existing stormwater management system serving existing land uses that results in reduced stormwater pollutant loadings. Generally, retrofit projects are large regional stormwater systems that are constructed by the public sector and do not serve new development or redevelopment. However, retrofit projects can also include a public-private partnership wherein the part of the treatment capacity is reserved for future development or redevelopment.

C.2. Goals and Performance Standards

Section 62-40.432(2)(c), F.A.C., states that pollutant loading from older stormwater management systems will be reduced as necessary to restore or maintain the designated uses of waters. Load reduction requirements established in adopted TMDLs or BMAPs should be considered in the design of retrofit projects to maximize load reduction credits. If the applicant has conducted, and the County has approved, an analysis that provides reasonable assurance that the proposed retrofit will provide the intended pollutant load reduction from the existing system or systems, the retrofit project will not be required to comply with the performance standards set forth in Section 3.1.1 of this Manual. The applicant for a retrofit project must provide reasonable assurance that the retrofit project itself will not result in new adverse water quality and quantity impacts to receiving waters.

C.3. Design and Selection of Applicable BMPs

The applicant should conduct a feasibility assessment to determine which BMP(s) and design criteria will provide the greatest pollutant removal in the most cost-effective manner given the limitations of the project site. When site conditions allow, stormwater retrofit BMPs will be designed to the BMP design criteria set forth in this Manual. However, in many cases, site constraints commonly encountered in existing, developed areas can limit the type and size of stormwater BMPs used for retrofitting. In addition to the traditional treatment BMPs specified in this Manual, a number of other BMPs may be suitable for regional retrofitting projects including "stormwater parks" and alum injection systems. However, it is best to select BMPs for retrofit projects that provide the greatest "bang for the buck" in reducing stormwater pollutants.

Appendix D – Florida Department of Environmental Protection Management Action Plan

Best Management Practice (BMP) Efficiencies

Table 1. Provisional Stormwater BMPs			
Standard BMPs	TP % Reduction	TN % Reduction	Data Source
Off-line Retention 0.25" treatment volume	40	40	Harper, H. & D. Baker. 2007. <i>Evaluation of Current Stormwater Design Criteria within the State of Florida.</i>
Off-line Retention 0.50" treatment volume	62	62	
Off-line Retention 0.75" treatment volume	75	75	
Off-line Retention 1.00" treatment volume	84	84	
On-line Retention 0.25" treatment volume	30	30	
On-line Retention 0.50" treatment volume	52	52	
On-line Retention 0.75" treatment volume	65	65	
On-line Retention 1.00" treatment volume	74	74	
Wet detention ponds	Reduction from Figure 13.2 given the project's residence time	Reduction from Figure 13.3 given the project's residence time	Figures from March 2010 Department of Environmental Protection and Water Management Districts <i>Environmental Resource Permit Draft Stormwater Quality Applicant's Handbook</i>
BMP treatment trains using a combination of BMPs	Use BMP Treatment Train (TT) equation: BMP TT Efficiency = $Eff_1 + ((1 - Eff_1) * Eff_2)$	Use BMP Treatment Train (TT) equation: BMP TT Efficiency = $Eff_1 + ((1 - Eff_1) * Eff_2)$	Figures from March 2010 Department of Environmental Protection and Water Management Districts <i>Environmental Resource Permit Draft Stormwater Quality Applicant's Handbook</i>
Dry detention	10	10	Harper, H. & D. Baker. 2007. <i>Evaluation of Current Stormwater Design Criteria within the State of Florida.</i>
Baffle box	2.3	0.5	Final Report Contract S0236 Effectiveness of Baffle Boxes
Nutrient baffle box (2 nd generation)	15.5	19.05	Final Report Contract S0236 Effectiveness of Baffle Boxes
Grass swales with swale blocks or raised culverts	Use on-line retention BMPs above	Use on-line retention BMPs above	Evaluation of Harper data

Table 1. Provisional Stormwater BMPs			
<i>Standard BMPs</i>	<i>TP % Reduction</i>	<i>TN % Reduction</i>	<i>Data Source</i>
Grass swales without swale blocks or raised culverts	50% of value for grass swales with swale blocks or raised culverts	50% of value for grass swales with swale blocks or raised culverts	Evaluation of Harper data
Alum injection	90	50	Evaluation of Harper data
Stormwater reuse	Estimate amount water not discharged annually because used for irrigation.	Estimate amount water not discharged annually because used for irrigation.	Evaluated on a case-by-case basis
Stormceptor	13	2	Final Report Contract S0095 Sanford Stormceptor project
Continuous deflective separation (CDS) units	10	Not applicable	Final Report Contract WM793 Broadway Outfall Project
Street sweeping	Determine the dry weight/volume of material collected annually and multiply by values provided by the Florida Stormwater Association (FSA) University of Florida (UF) municipal separate storm sewer system (MS4) BMP project	Determine the dry weight/volume of material collected annually and multiply by values to be provided by FSA UF MS4 BMP project	Final Report of FSA UF MS4 BMP Project
Catch basin inserts/inlet filters	Determine the dry weight/volume of material collected annually and multiply by values to be provided by FSA UF MS4 BMP project	Determine the dry weight/volume of material collected annually and multiply by values to be provided by FSA UF MS4 BMP project	Final Report of FSA UF MS4 BMP Project
Septic tank phase out	Based on values from ArcNLET model	Based on values from ArcNLET model	https://people.sc.fsu.edu/~mye/ArcNLET/index.html

Note: The Draft Stormwater Quality Applicant's Handbook is located at http://publicfiles.dep.state.fl.us/dwrm/stormwater/stormwater_rule_development/docs/ah_rule_draft_031710.pdf

Table 1. Provisional Stormwater BMPs			
<i>Provisional BMPs</i>	<i>TP % Reduction</i>	<i>TN % Reduction</i>	<i>Data Source</i>
Public education	1-6, depending on extent of program	1-6, depending on extent of program	Evaluation of Center for Watershed Protection. 2002. Watershed Treatment Model Version 3.1. See separate calculation spreadsheet.
Muck removal/ restoration dredging	Case-by-case depending on the nutrient flux of the muck	Case-by-case depending on the nutrient flux of the muck	FDEP Muck Removal Credit Guidance (developed for the Indian River Lagoon BMAPs)
Aquatic vegetation harvesting	Based on the total mass of material collected, type of plant(s), and associated nutrient content in the dry material	Based on the total mass of material collected, type of plant(s), and associated nutrient content in the dry material	FDEP Removal of Aquatic Vegetation for Nutrient Credits (developed for the Indian River Lagoon BMAPs)

Table 1 from Mark Clark, Stormwater Considerations in Residential Developments, PowerPoint presentation 1-17-09.

Appendix E – Pinellas County Receiving Waters and TMDL Status

For more information on TMDLs, and a searchable list of those applicable to Pinellas County, please visit: <https://pinellas.gov/regulatory-programs>

Appendix F – Inspection Form

OPERATION AND MAINTENANCE INSPECTION CERTIFICATION

Instructions: Submit this form to the County within 30 days of completion of the inspection after any failure of a stormwater management system or deviation from the permit.

Permit No.: _____ Application No.: _____ Date Issued: _____

Identification or Name of Stormwater Management System: _____

Phase of Stormwater Management System (if applicable): _____

Inspection Date: _____

Inspection results: (check all that apply)

- The undersigned hereby certifies that the works or activities are functioning in substantial conformance with the permit. This certification is based upon on-site observation of the system conducted by me or my designee under my direct supervision and my review of as-built plans.
- The following maintenance was conducted since the last inspection (attach additional pages if needed):

-
- The undersigned hereby certifies that I or my designee under my direct supervision has inspected this surface water management system and the system does not appear to be functioning in substantial conformance with the permit. I am aware that maintenance or alteration is required to bring the system into substantial compliance with the terms and conditions of the permit. As appropriate, I have informed the owner of the following:
 - (a) The system does not appear to be functioning properly;
 - (b) That maintenance or repair is required to bring the system into compliance; and
 - (c) If maintenance or repair measures are not adequate to bring the system into compliance, the system may have to be replaced or an alternative design constructed subsequent to approval by the County.

The following components of the system do not appear to be functioning properly (attach additional pages if needed):

Name of Inspector: _____ Florida Registration Number: _____

Company Name: _____

Mailing Address: _____

City _____ State: _____ Zip Code: _____

Phone: _____ Fax: _____ Email: _____

Signature of Inspector Date

Report Reviewed by Permittee:

Name of Permittee: _____

Signature of Permittee Date

Title (if any)

Appendix G – Definitions and Acronyms

<i>Term</i>	<i>Definition</i>
“Best Management Practice” or “BMP”	A design/land management practice used to manage and treat stormwater runoff and prevent or reduce erosion.
“Closed Watershed/Drainage Basin”	Any drainage basin in which the runoff does not have a surface outfall up to and including the 100-year flood level OR any drainage basin that does not ultimately discharge to a tidal waterbody.
“Confining unit”	A stratum or layer of clay, hardpan, organic mucks, or other material that restricts the movement of water below that strata or layer.
“Control elevation”	The lowest elevation at which water can be released through a control device.
“Detention”	The collection and temporary storage of stormwater with subsequent gradual release of the stormwater.
“Directly connected impervious area,” or “DCIA”	The area covered by a building, impermeable pavement, and/or other impervious surfaces, which drains directly into the conveyance without first flowing across sufficient permeable vegetated land area to allow for infiltration of runoff.
“Development” or “development activity”	<p>a) The construction, installation, alteration, and demolition or removal of a structure or an impervious surface.</p> <p>b) Clearing, scraping, grubbing or otherwise removing, altering or destroying the vegetation of a site.</p> <p>c) Adding, removing, exposing, excavating, leveling, grading, digging, burrowing, dumping, piling, dredging, or otherwise significantly disturbing the soils or altering the natural topographic elevations of the site.</p> <p>d) The maintenance of a lawn and its ancillary vegetation, excluding uplands as required in sections 166-50 and 166-51, is exempted.</p> <p>e) Redevelopment /partial redevelopment of existing commercial building</p>
“Diameter at breast height” or “dbh”	A method of expressing the diameter of the trunk or bole of a standing tree.
“Discharge”	To allow or cause water to flow to receiving waters or off-site properties.
“Elevation”	Vertical height, for the purposes of this manual all elevations referenced are in NAVD88
“Existing land use”	The land use activities that exist on the project site as of the effective date of this Manual.
“Hydrologic Unit Code” or “HUC”	The hydrologic cataloging unit assigned to a geographic area representing a surface drainage basin.
“Impervious”	Land surfaces that do not allow, or minimally allow, the penetration of water; such as building roofs, non-porous concrete and asphalt pavements, and some fine grained or compacted soils.

"Invasive or nuisance vegetation"	A species found on the Florida Exotic Pest Plant Council list http://www.fleppc.org/
"Common Plan of Development"	Any development which consists of multiple (3 or more) lots under common ownership or are to be developed in separate stages or phases as part of common plan requiring a site plan review.
"Florida-Friendly™"	Any practice associated with landscaping, such as groundcover, plants, trees, mulch, watering, fertilization, pest management, etc. that has been categorized as suitable for Florida's unique environment. Certain types of landscaping, such as synthetic turf and rubber mulch, are not considered Florida-Friendly™ and are prohibited from use as groundcover and stormwater BMP stabilization under this manual.
"Green Infrastructure"	Any BMP that preserves, restores, or mimics natural processes. For stormwater management, green infrastructure BMPs allow rainwater to filter through vegetation and soil at its source rather than being piped and directed it elsewhere. This approach reduces stormwater runoff and provides many other ancillary benefits, including water quality, habitat, air quality, energy use reduction, aesthetic, social, and economic gains. These types of BMPs are not limited just to stormwater management and may include infrastructure used to protect banks/shores from erosion, such as living shorelines.
"Large Site"	Any parcel greater than 1 acre.
"Littoral zone"	That portion of a wet detention pond that is designed to contain rooted aquatic plants.
Major Stormwater/Drainage Channel	A stormwater conveyance system identified in the County's Stormwater Master Plan or Watershed Management Plans that drains an area of 200 or more acres.
"Net improvement"	The performance standard for stormwater discharges that are required to cause net improvement (overall reduction of pollutants) of the receiving water body for those parameters that do not meet standards.
"Nuisance tree"	Those trees listed in Table 138-3653.a or found on the Florida Exotic Pest Plant Council list http://www.fleppc.org/
"Off-line"	The storage of a specified volume of stormwater so that subsequent runoff in excess of the specified volume does not flow into the BMP storing the initial volume of stormwater.

“On-line”	A flow- through retention or detention BMP with an inflow and an outflow that provides stormwater treatment within the flow path of runoff.
“Open Watershed/Drainage Basin”	Any drainage basin not meeting the definition of a closed drainage basin.
“Operate” or “operation”	To cause or to allow a system to function.
“Outstanding Florida Waters” or “OFWs”	A waterbody/feature designated by the Florida Department of Environmental Protection (DEP) under the authority of Section 403.061(27) Florida Statutes that is worthy of special protection because of its natural attributes.
“Pre-development”	Land use and hydrologic conditions existing prior to conducting proposed development activities.
“Post-development”	Land use and hydrologic conditions existing after proposed development activities are completed.
“Permanent pool”	That portion of a wet detention pond that holds water between the normal water level and the top of the anoxic zone excluding any water volume claimed as wet detention bleed-down volume.
“Permeable Surface”	Land and surfaces that are capable of being infiltrated, by liquids (gases are irrelevant).
“Project area”	The area being modified or altered in conjunction with an activity requiring a permit.
“Redevelopment”	Any manmade material change to improved real estate resulting in a change in footprint, including but not limited to buildings or other structures, mining, dredging, filling, grading, paving, excavation or drilling operations. Demolition which removes existing impervious surfaces to the native soil surface.

<p>“Registered professional”</p>	<p>A professional registered or licensed by and in the State of Florida and who possesses the expertise and experience necessary for the competent preparation, submittal and certification of documents and materials, and performing other services required in support of permitting, constructing, altering, inspecting, and operating a proposed or existing activity regulated under Part IV of Chapter 373, F.S. Examples of registered professionals, authorized pursuant to Chapter 455, F.S., and the respective practice acts by</p>
	<p>which they are regulated, are professional engineers licensed under Chapter 471, F.S., professional landscape architects licensed under Chapter 481, F.S., professional surveyors and mappers under Chapter 472, F.S., and professional geologists licensed under Chapter 492, F.S.</p>
<p>“Retention”</p>	<p>A stormwater treatment system designed to prevent the discharge of a given volume of stormwater runoff into surface waters by complete on-site storage of that volume.</p>
<p>“Seasonal high groundwater table” (SHGWT)</p>	<p>The zone of runoff water saturated soil at the highest average depth during the wettest season of the year during periods of normal rainfall, based upon site specific factors described in Section 21 of this Manual.</p>
<p>“Semi-impervious”</p>	<p>Land surfaces that partially restrict the penetration of water; included as examples are pervious pavements, lime rock, and other compacted materials.</p>
<p>“Small Site”</p>	<p>Any parcels that are one acre or less.</p>
<p>“Soil Survey”</p>	<p>A document prepared by the U.S. Natural Resources Conservation Service that provides soil maps and interpretations useful for guiding decisions about soil selection, use, and management.</p>

<p>“Specimen tree”</p>	<p>(1) Any tree in fair or better condition which equals or exceeds the following diameter sizes:</p> <ul style="list-style-type: none"> a. Large hardwoods, e.g., oaks, hickories, sweetgums, gum, etc., 36 inches dbh. b. Large softwoods, e.g., pines, cypress, cedars, etc., 20 inches dbh. <p>(2) A tree in fair or better condition must meet the following minimum standards:</p> <ul style="list-style-type: none"> a. A life expectancy of greater than 15 years. b. A relatively sound and solid trunk with no extensive decay or hollow, and less than 20 percent radial trunk dieback. c. No more than one major and several minor dead limbs (hardwoods only). d. No major insect or pathological problem. <p>(3) A lesser sized tree can be considered a specimen if it is a rare or unusual species, of exceptional quality, or of historical significance.</p> <p>(4) A lesser size tree can be considered a specimen if it is specifically used by a builder, developer, or design professional as a focal point in a project of landscape.</p>
<p>“Stormwater”</p>	<p>Precipitation that accumulates in natural and/or constructed storage and stormwater systems during and immediately following a storm event.</p>
<p>“Stormwater harvesting”</p>	<p>The beneficial use of treated stormwater to reduce the volume of stormwater and the associated pollutant load discharged from a stormwater treatment system, but specifically does not include reclaimed water as defined in Chapter 62-610, F.A.C.</p>
<p>“Stormwater management system”</p>	<p>A system which is designed and constructed or implemented to control discharges which are necessitated by rainfall events, incorporating methods to collect, convey, store, absorb, inhibit, treat, use, or reuse water to prevent or reduce flooding, overdrainage, environmental degradation, and water pollution or otherwise affect the quantity and quality of discharges from the system.</p>
<p>“Stormwater treatment system”</p>	<p>A system which is designed and constructed or implemented to reduce the pollutant loadings in stormwater discharges by incorporating methods to collect, convey, store, absorb, treat, use, or reuse stormwater.</p>

"Swale"	<p>A manmade trench which:</p> <ol style="list-style-type: none"> (1) Has a top width to depth ratio of the cross-section equal to or greater than 6:1, or side slopes equal to or flatter than 3 feet horizontal to 1 foot vertical; (2) Contains contiguous areas of standing or flowing water only following a rainfall event; (3) Is planted with or has stabilized vegetation suitable for soil stabilization, stormwater treatment, and nutrient uptake; and (4) Is designed to take into account the soil erodibility, soil percolation, slope, slope length, and watershed/drainage area so as to prevent erosion and reduce pollutant concentration of any discharge.
"Tailwater"	The receiving water elevation (or pressure) at the final discharge point of the stormwater management system. (NAVD88)
"Variance"	A deviation or adjustment from the dimensional and technical provision of the Administrative Code other than those already listed as Administrative Adjustments.
"State water quality standards"	Those standards set forth in Chapters 62-4, 62-302, 62-520, and 62-550, F.A.C., including the antidegradation provisions of paragraphs 62-4.242(1)(a) and (b), F.A.C., subsections 62-4.242(2) and (3), F.A.C., and Rule 62-302.300, F.A.C.
"Waters of the state"	Those waters defined in Section 403.031(13), F.S.
"Wet detention"	The collection and temporary storage of stormwater in a permanently wet impoundment in such a manner as to provide for treatment through physical, chemical, and biological processes with subsequent gradual release of the stormwater.
"Wetlands"	<p>Those areas that are inundated or saturated by surface water or groundwater at a frequency and a duration sufficient to support, and under normal circumstances do support, a prevalence of vegetation typically adapted for life in saturated soils.</p> <p>Soils present in wetlands generally are classified as hydric or alluvial or possess characteristics that are associated with reducing soil conditions. The prevalent vegetation in wetlands generally consists of facultative or obligate hydrophytic macrophytes that are typically adapted to areas having soil conditions described above. These species, due to morphological, physiological, or reproductive adaptations, have the ability to grow, reproduce or persist in aquatic environments or anaerobic soil conditions. The landward extent of wetlands is delineated pursuant to Rules 62-340.100 through 62-340.550, F.A.C., as ratified by Section 373.4211, F.S.</p>

Acronyms

Full Term

AASHTO

Association of State Highway Transportation Officials

ADT	Average Daily Traffic
ARC	Antecedent Runoff Condition
ASTM	American Society for Testing Material
BAM	Biosorption Activated Media
BMAP	Basin Management Action Plan
BMP	Best Management Practices
BOD	Biological Oxygen Demand
CC&R	Conditions Covenants and Restrictions
CGP	Construction Generic Permit
CN	Curve Number
CUP	Consumptive Use Permit
CY	Container Yard
dbh	Diameter at Breast Height
DCIA	Directly Connected Impervious Area
DEP	Department of Environmental Protection
DOT	Department of Transportation
EIA	Equivalent Impervious Area
EMC	Event Mean Concentrations
EPA	Environmental Protection Agency
ERIK	Embedded Ring Infiltrometer Kit
ERP	Environmental Resource Permit
ET	Evapotranspiration
F.A.C.	Florida Administrative Code
FDOT	Florida Department of Transportation
FDEP	Florida Department of Environmental Protection

FEMA	Federal Emergency Management Agency
F.S.	Florida Statute
FYN	Florida Yards and Neighborhoods
GR	Green roof
HSG	Hydrologic Soils Groups
HOA	Home Owners Association
HUC	Hydrologic Unit Code
IDF	Intensity-Duration-Frequency
ISA	International Society of Arboriculture
KCL	Potassium Chloride
LDC	Land Development Code
LEED	Leadership in Energy and Environmental Design
LID	Low Impact Development
LOS	Level of Service
MAPS	Managed Aquatic Plant Systems
MS4	Municipal Separate Storm Sewer System
N	Nitrogen
NAVD	North American Vertical Datum
NOAA	National Oceanic and Atmospheric Administration
NPDES	National Pollutant Discharge Elimination System
NRCS	Natural Resources Conservation Service
NTU	Nephelometric Turbidity Units
O&M	Operations and Maintenance
OFW	Outstanding Florida Waters

P	Phosphorus
pH	Potential Hydrogen
psi	Pounds per Square Inch
REV	Rate-Efficiency-Volume
RTV	Required Treatment Volume
SC	Source Control
SHGWT	Seasonal High Groundwater Table
SMS	Soil Moisture Sensors
SP	Site Planning
SPT	Standard Penetration Test
SRN	Slow-Release Nitrogen
SW	Stormwater
SWFWMD	Southwest Florida Water Management District
SWMM	Storm Water Management Model
SWMP	Stormwater Master Plan
SWPPP	Stormwater Pollution Prevention Plan
T _c	Time of Concentration
TMDL	Total Maximum Daily Loads
TN	Total Nitrogen
TOB	Top of Bank
TP	Total Phosphorus
TSS	Total Suspended Solids
USDA	United States Department of Agriculture
VNB	Vegetated Natural Buffers
WUP	Water Use Plan

Appendix H: Example Projects Using Green Infrastructure

Residential

Name	Location	Additional Information
Madera residential community	Gainesville, FL	https://www.asla.org/uploadedFiles/CMS/Advocacy/Federal_Government_Affairs/Stormwater_Case_Studies/StormwaterCase455MaderaCommunityandModelCenterGainesvilleFL.pdf
Magdalene Reserve	Tampa, FL	https://www.asla.org/uploadedFiles/CMS/Advocacy/Federal_Government_Affairs/Stormwater_Case_Studies/Stormwater%20Case%20347%20Magdalene%20Reserve.%20Tampa.%20FL.pdf

Mixed-Use

Name	Location	Additional Information
Encore	Tampa, FL	https://encoretampa.com/category/media-coverage/
201 Main Street, LLC (Café/Condo development)	Safety Harbor, FL	Tree box filter, permeable pavers

Commercial

Name	Location	Additional Information
Armature Works	Tampa, FL	https://armatureworks.com/
Curtis Hixon Waterfront Park	Tampa, FL	https://www.rsandh.com/projects/curtis-hixon-waterfront-park/
Largo Mall	Largo, FL	Pervious parking spaces

Governmental

Name	Location	Additional Information
Scott Street	Tampa, FL	Green gutters
MacDill AFB	Tampa, FL	Living shoreline
Bioactivated Media (BAM Pilot Project)	Pinellas County, FL	Modular wetland, rain garden, and water polisher upflow filter

Pervious residential streets	Largo, FL	Henrietta and Jean Streets
Recreation center	Largo, FL	Rain garden
Nutrient removing baffle box	Tarpon Springs, FL	Structure has a clear top and educational signage and is adjacent to the Pinellas Trail
Anderson Park	Pinellas County, FL	Rain garden
Pinellas County Extension	Largo, FL	Bioretention cell in parking lot
PK Avenue	Auburndale, FL	Bioswales
Siesta Waterway Project	Sarasota, FL	Stormwater management channel – no-mow slopes with native vegetation
Honore Avenue	Sarasota, FL	Bioswales
Dune treatment systems	Venice, FL	Sand dune treatment systems planted with natives like railroad vine
Veterans Memorial and Freedom Pavilion	Englewood, FL	Bioswales
5 th Street Revitalization	Palmetto, FL	Biofiltration planter boxes, pervious pavement, rain gardens/bioswales, green gutters

For details on more development projects that use green infrastructure and the benefits realized, visit:

<https://uli.org/wp-content/uploads/ULI-Documents/HarvestingtheValueofWater.pdf>

Some additional case studies were done as part of the development of this stormwater manual and they can be found here:

http://www.pinellascounty.org/drs/stormwater_manual.htm

Appendix I: Bioretention Media Supplemental Specification

In recognition that there are different manufacturers of bioretention media/biosorption activated media(BAM) with many types of mixtures available, Pinellas County has developed a specification to outline the requirements for the use of bioretention media/BAM. The specification includes requirements for the composition, delivery, handling, storage, testing, quality, installation, and performance of bioretention media/BAM.

This specification can be found here: <https://pinellas.gov/stormwater-manual>

Appendix J: List of Plants and Trees for BMPs

To assist applicants with the selection of suitable plants, Pinellas County has developed a [searchable list of suggested plants, trees, and groundcover](#).

Some important notes regarding the list:

- Trees may require additional engineered soil depth.

- This list presents some landscape favorites known for being highly drought tolerant and/or flood tolerant. The list does not represent all possible plant/tree species – there are many more native and Florida Friendly plant options that could be used. For more options, please visit:
 - UF IFAS [Florida Friendly Landscaping Program](#):
 - [Florida-Friendly Landscaping™ Guide to Plant Selection & Landscaping Design](#) by the University of Florida Institute of Flood and Agriculture Sciences (UF/IFAS)
 - [Florida Friendly™ Interactive Plant search tool](#)
 - [Florida Yards and Neighborhoods plant database](#)
 - [Florida Native Plant Society – Native Plants for your Area search tool](#)

- Any plants on the [Florida Friendly Plant \(FFP\) List](#) can receive credit from Pinellas County Development Review Services if they are used in the appropriate USDA zone and meet the minimum size, spacings, grade, etc. requirements of [Section 138 of the Land Development Code \(LDC\)](#). If the customer chooses to use a species not on the FFP list, the plant(s) cannot be used to satisfy any plant requirement under the LDC. All plants native to Florida are considered “Florida Friendly”.



PINELLAS COUNTY
STORMWATER MANUAL
REFERENCES



REFERENCES

- Austin Texas (2012). City of Austin Texas Environmental Criteria Manual. Section 1.6, Austin. Caltrans
- (2006). Highway 267 Filter Fabric Sand Trap Pilot Study, 2004–2005 Interim Report, California Department of Transportation, CTSW-RT-05-157.01.1.
- Chang, N., F. Hossain, M. Wanielista (2010). Filter Media for Nutrient Removal in Natural Systems and Built Environments: Previous Trends and Perspectives. *Environmental Engineering Sciences*, Volume 27, Number 9, pp 689-706.
- EPA, Environmental Protection Agency (2008). Stormwater Technology Fact Sheet: Sand Filters. Washington D.C. EPA 832-F-99-007, September.
- Hardin, M., M. Wanielista, and M. Chopra (2012). A Mass Balance Model for Designing Green roof Systems that Incorporate a Cistern for Re-Use. *Water*, 4, 1, doi: 10.3390/w40.
- Kim, H. H., E. A. Seagren, and A. P. Davis (2003). Engineered Bioretention for Removal of Nitrate from Stormwater Runoff, *Water Environment Research*, 75 (4): 355–367.
- Ma, J., K. Tracy, and J. Lenhart (2009). Phosphorus Removal in Urban Runoff Using Adsorptive Filtration Media, *Proceedings of Storm-Con 2009*, August 16–20, Anaheim, CA.
- MassHighway (2004). Storm Water Handbook for Highways and Bridges, Massachusetts Highway Department.
- Milesi, C., S. A. de Ridder, D. DeLeon, H. Wachter (2006). A Comparison of Two Media Filtration BMP Treatments for the Removal of PAHs and Phthalates from Roadway Runoff, *Proceedings of StormCon 2006*. July 24–27, Denver, CO.
- O'Reilly, A., M. Wanielista, N. Chang, Z. Xuan, and W. Harris (2012). Nutrient removal using biosorption activated media: Preliminary biogeochemical assessment of an innovative stormwater infiltration basin. *Journal: Science of the Total Environment*. May.
- Pitt, R. and S. Clark (2010). Evaluation of Biofiltration Media for Engineered Natural Treatment Systems, Department of Civil, Construction and Environmental Engineering, University of Alabama.
- Ryan, P., M. Wanielista and N. Chang (2009). Nutrient Reduction in Stormwater Pond Discharge Using a Chamber Up-flow Filter and Skimmer (CUFS), *Water, Air and Soil Pollution*, doi:10.1007/s11270-009-0174-x, Aug.
- Wanielista, Martin and Ni-Bin Chang (2008). Alternative Stormwater Sorption Media for the Control of Nutrients, Final Report: Project #B236, Southwest Florida Water Management District, Brooksville, FL.
- Wanielista, Martin, Ni-Bin Chang, Andrew Randall, Manoj Chopra, Mike Hardin, Jamie Jones, Andrew Hood, and Sultan Salamah (2014). Demonstration Bio Media for Ultra-urban Stormwater Treatment, Florida Department of Transportation, Tallahassee, FL.
- Williams, Shane and Martin Wanielista (2015). Improved Nitrogen Efficiencies in Dry Ponds, Florida Stormwater Association Annual Meeting, June 18.
- WSDOT (2008). Washington State Department of Transportation Highway Runoff Manual, M 31-16.01, Environmental and Engineering Programs Design Office.