

Denhardt and Rubenstein
Attorneys at Law

James W. Denhardt

Lauren Christ Rubenstein

2700 First Avenue North
St. Petersburg, Florida 33713
Telephone (727) 327-3400
Facsimile (727) 323-0888

November 23, 2021

Pinellas County Board of
County Commissioners
315 Court Street
Clearwater, Florida 33756

RE: Dock Variance Request Pertaining to Historic Boathouse at 3612 E. Maritana Drive

Dear Commissioners:

This is a Variance Request concerning the historic boathouse located at 3612 E. Maritana Drive, St. Pete Beach. This request is being filed in conjunction with the applicant's Water and Navigation permit (WND-21-00540) for a small 10' x 16' floating dock with an additional tie pole for stability and a 14' x 4' aluminum gangway (see sketch attached hereto as Exhibit A). These minor additions to the existing dock are needed to enter and exit the applicant's boat that is currently moored at the property.

The applicants, Kelly Lee McFrederick and Jack Rice, acquired the property in January of 2021. The deeded land has 200 feet of original seawall protected by rip-wrap built up from 1941. The property, known as the "Captain's House," features a historic dock and boathouse that was constructed at some point between 1920 and 1940, which has received Local Historic Designation by the City of St. Pete Beach (the Local Historic Designation approval letter is attached hereto as Exhibit B). One of the better-known property owners was John L. Downing, Jr. (M HONOR) boat captain, who was Augie Bush's boat captain of Miss Budweiser. In fact, when you visit the Gulf Beaches Historical Museum, you are immediately greeted with a photograph circa 1941 clearly depicting the historic boathouse (photograph attached hereto as Exhibit C).

The original historic dock of approximately 227 square feet includes the roof and the covered dock with a slip underneath, the dock to the south side, the roof covering the wet slip, plus the entrance walkout dock. These original structures still remain today, and as shown in the picture from 2012 (attached hereto as Exhibit D), is exactly how the dock

existed for over 60 years. The original trusses and framework in the roof are still there, with pilings added to the original pilings for stability. The shape and structure of the roof are original, and the walkout section of the dock, the horizontal dock to the seawall, and the south dock covered section makeup the original footprint. Attached to provide additional detail of the historic dock are permit applications filed with the County in 1988 and 1991. Such permit applications have been attached hereto and incorporated herein as Composite Exhibit E.

In 2013, a previous property owner installed 6 new tie poles to the south of the existing structure. The 2013 Pinellas County Permit is attached hereto and incorporated herein as Exhibit F. The result of the work completed in 2013 is evidenced by pictures from 2016 showing the historic boathouse and dock, with the additional tie poles that create a large wet slip directly to the south of the historic structure. Such pictures are attached hereto and incorporated herein as Composite Exhibit G.

In 2018, the historic dock and boathouse saw its most major changes and additions since its inception. The previous property owner performed substantial maintenance to the original docks and boathouse, which included replacing all the boards and handrails, replacing the shingles on the roof and installing necessary hurricane clips to ensure the structure could safely withstand potential storms and not pose a threat to any nearby properties or structures. The 2018 permit also included an additional covered boatlift with a proposed finger pier/catwalk that would be attached to the historic structure directly to its north. This addition blocked access to the historic boathouse from the north, limiting its ability to be used as a functional wet slip. The 2018 Pinellas County approved permit application is attached hereto and incorporated herein as Exhibit H.

All the work that was proposed on the 2018 permit was completed, and the result was a completely refurbished historical structure with the existing 6 piling wet slip to the south and a newly constructed covered boatlift to the north. Pictures of the completed dock from 2020 are attached hereto and incorporated herein as Composite Exhibit I.

While the above described history appears straightforward, the 2018 permit application and resulting work by the previous property owners has created a nightmare situation for the current owners, Kelly Lee McFrederick and Jack Rice. Kelly Lee and Jack were drawn to the property for one reason, and one reason only. They own a 63 foot Prestige boat. As you may imagine, finding a piece of waterfront property in Pinellas County with a dock that can accommodate such a boat are few and far between. The existing dock at 3612 E. Maritana Drive, with its 30 foot wide wet slip, was a dream come true. Kelly Lee and Jack had finally found a home where they could keep their boat, and would be able to simply walk across the street to their dock to begin a day out on the water and enjoy their property

rights of home ownership. Kelly Lee McFrederick (who is a licensed Realtor) fully researched the property's history, in addition to the normal title search, and confirmed that there were no outstanding permits pertaining to the dock. The existing dock was absolutely perfect for their needs. The only addition that would need to be made was a small floating dock and gangway to be able to enter and exit the 63 foot Prestige, as boarding is only possible on the stern of the boat. Prior to purchasing the property, Kelly Lee reached out to the City of St. Pete Beach to confirm the addition of the floating dock and gangway would be possible and was verbally assured it would not be a problem. Upon purchasing the property, Kelly Lee and Jack immediately hired a contractor to apply for the small floating dock and aluminum ramp.

When the contractor first began the permitting application with St. Pete Beach, it is my understanding that St. Pete Beach provided the contractor with a copy of what it believed at the time to be the latest permit application. The sketch the City provided was actually from 2013, which showed the six tie poles to the south of the dock, but did not include any of the 2018 improvements on the north side of the dock. The contractor added the proposed new floating dock and aluminum ramp to the 2013 sketch, and provided that to the City. Upon closer review, the City realized that there was a permit from 2018, and sent the permit application from 2018 to the contractor for its use. As requested, the contractor utilized the 2018 sketch, and added the proposed new 10' x 16' floating dock, 14' x 4' aluminum ramp and the new proposed piling to help stabilize the floating dock. At the time, the contractor did not think much about the six tie poles to the south of the dock not being shown on the 2018 permit drawing that was supplied by the City. The contractor did label and show the existing piling that would be next to the floating dock, as it was an integral part of the construction that would take place. The fact that the six existing tie poles from 2013 were not shown on the sketch submitted with the 2018 application to add a new proposed covered boatlift to the north of the existing dock, is what seems to have created this nightmare situation. Of importance, attached to the 2018 application was the 2013 application and sketch showing the six existing tie poles. Those tie poles were installed in 2013, as permitted by Pinellas County, and have never been removed.

When Pinellas County received the 2021 application for the proposed floating dock and aluminum ramp, County staff visited the subject property to conduct a site visit. Supposedly, it was at that time County staff realized that the six tie poles permitted in 2013 were still existing. County staff immediately took the position that those poles were "unpermitted," and needed to be removed, or the applicant needed to pay five times the permit fee for the new application due to what staff considered "unpermitted structures." But the even bigger problem was that County staff also took the position that with the existing tie poles, the historic boathouse, and the covered boatlift that was added in 2018, the property had more than two boat slips in violation of Pinellas County Code Section 58-

555(a)(5) which states that "a dock shall not be designed or constructed to accommodate more than two boats for permanent mooring."

In conversations with Pinellas County staff, we have made it clear that my clients do not utilize the historic boathouse as a boat slip for permanent mooring. As you can see from the 2018 additions, it is nearly impossible to utilize such area as a functional boat slip due to the 2018 improvements blocking the northern access to the historic boathouse. Kelly Lee and Jack also proposed recording a Restrictive Covenant that would run with the land stating that such area cannot be utilized as a boat slip for permanent mooring, with such Restrictive Covenant only to be released with the consent of Pinellas County. County staff rejected such proposal, and continued to further complicate matters by asserting that the historic roof, if not over a boat slip, would need to be removed as it would be in violation of County Code Section 58-543(m) that states "no roof structure other than covered boat slips and no vertical walls will be allowed."

Attached as Exhibit J is an email received from the County Attorney's office regarding the above items, as well as some additional comments and concerns. As you can see, Water and Navigation staff also proposed reducing the width of the platform located under the roof to reduce the walkout to five feet wide, rather than the existing 9.1' x 18'. The 9.1' x 18' platform is an integral part of the locally designated historic structure that has existed for almost a century! What is worse, is that Water and Navigation staff's request for such change and removal of a portion of such platform was not supported by any requirements in the Pinellas County Code. In the attached email, Assistant County Attorney Mackesey also provided a lengthy explanation of why staff was requiring five times the permit fee. When the permit application was originally submitted to Pinellas County, the contractor did deliver the floating dock and tie it up to the existing dock. However, there was no construction that commenced, and nothing was ever permanently attached to the existing dock, rather it was simply delivered there for installation once final approvals from the County were received. Upon Pinellas County staff taking the position that its mere presence on the property constituted unpermitted work, Kelly Lee and Jack immediately had the contractor remove the unattached floating dock. Regardless, County staff still refuses to accept that the tie poles permitted in 2013 are permitted structures, and continues to demand five times the application fee be paid.

After the July 16, 2021 email from the County Attorney's office, numerous meetings and conversations were held to try and resolve the issues at hand. In late August, the County Attorney's office reached out again regarding a new offer from Pinellas County as a result of a meeting with Kelli Levy, Administrator of Public Works. The County was proposing moving the tie poles to be out in front of the existing historic structure, which would result in access to the boathouse being blocked from all sides. As part of the offer, the County

would be willing to waive five times the fee and allow the roof to remain, but would ask that the area under the boathouse be furnished with handrails to prevent it from being used as a boat slip. Kelly Lee and Jack found this latest offer from Pinellas County to be a little strange. It did not appear to solve the issue previously raised by the County regarding a roof over an area that is not a boat slip, but was still requiring handrails be installed under the historic roof, and also requiring the tie poles be moved in such a way that their boat would essentially create a gate to block any and all access to the historic boathouse. Nevertheless, Kelly Lee and Jack analyzed whether or not mooring the boat in front of the historic boathouse would work logistically. It was determined that parking it parallel to the historic boathouse would result in the boat encroaching near the neighbor's projected property line, as well as create an issue as to how to get on and off the boat and no way to run power to the boat (Kelly Lee and Jack already permitted and spent \$9,000 to install an electrical pedestal on the dock near the existing tie poles). Mooring the boat parallel in front of the historic structure would also create a serious security concern for Kelly Lee and Jack not being able to see what was occurring on the other side of their boat, allowing strange boats to tie up to the other side of their boat and making it an easy target for thieves to board the boat and steal electronics and other valuable items. Mooring the boat parallel to the historic boathouse was simply not going to work.

Kelly Lee and Jack also looked at the possibility of parking the boat perpendicular in front of the historic boathouse. While the intracoastal waterway is very wide at the subject location, a 63 foot long boat sticking out into the intracoastal from the end of the dock would likely exceed 25% of the width of the waterway (the limit imposed by Pinellas County Code). It would also create an extreme safety hazard for boaters entering and exiting Hotel Zamora, especially on nights and weekends. The County then requested Kelly Lee and Jack allow them to conduct another site visit (staff had already been on site early in 2021, when they had shown up unannounced and rang the doorbell to request permission to access the dock and take measurements, luckily Jack was on his way home and able to grant staff access to the dock). The requested site visit would allow County staff to once again come on to the property to visually inspect and take any necessary measurements. County Staff was also interested in inspecting for potential oyster beds that it could argue would prevent the southern wet slip from being used. However, there are no oyster beds that encroach into such wet slip preventing its use and, in fact, the boat was already moored at such location. Nevertheless, in the hopes of finding a solution, Kelly Lee and Jack agreed to another site visit. A site visit was scheduled on September 17 at 3:00 p.m. However, as Kelly Lee, Jack and I stood on the dock waiting for Pinellas County's arrival, I received a telephone call at 2:47 p.m. from Assistant County Attorney Mackesey stating that the County had canceled the site visit due to potential bad weather in the area. The site visit was then rescheduled for October 6th. Our hope was that the October 6th site visit would help the County Attorney's office, as well as Water and Navigation staff, gain

a better understanding and perspective of the existing structure and corresponding boat slips.

While I do believe that the site visit was informative and gave the Assistant County Attorney and staff a better understanding of the property, the County's position remains unchanged. As a result, in order to preserve the historic boathouse and the marine structure that currently exists on this property, Kelly Lee and Jack respectfully request the Board of County Commissioners to authorize a Variance to either Section 58-543(m) or Section 58-555(a), which would allow the marine structure, all of which has been permitted in the past by Pinellas County, to rightfully remain in its current condition.

Pursuant to Section 58-539(a) the Board may review and decide whether to grant variances to all permitting criteria under Article XV- Water and Navigation Regulations. In deciding whether to grant a variance, the Board must make a positive finding of fact as to all the criteria set forth in Section 138-231, Pinellas County Land Development Code, as applicable. Section 138-231 lays out eight criteria to be considered in the granting of any variance:

- (a) *Special conditions.* That special conditions and circumstances exist which are peculiar to the land, structure, or building involved.

Analysis: Special conditions and circumstances do exist which are peculiar to the land, structure or building involved. The Pinellas County Water and Navigation Code, like any code, is written to apply to all waterfront properties throughout Pinellas County. Special conditions and circumstances do exist on the subject property, in that the property has 200 feet of seawall, and the subject structure has a historical boathouse that has existed on the property for over 80 years. Even with the wet slip to the south of the historic structure and the newly built covered boatlift from 2018 to the north of the historic structure, the southernmost tie poles are set back approximately 50 feet from the southern property line and the northernmost point of the structure is set back 68 feet from the north property line. To help put that into perspective, the four waterfront properties to the south of Kelly Lee and Jack's home have a waterfront width between 50 and 75 feet each. The property directly to the north has approximately 119.5 feet waterfront width, but because of the curvature of the neighboring properties, the northern property owner's boatlift is only set back 4 feet from the northern projected property line. Therefore, due to the large waterfront width of the property, combined with the fact that the property includes a locally designated structure, special conditions and circumstances do exist which are peculiar to the land, structure or building involved.

(b) *Unnecessary hardship.* That literal interpretation of the provisions of this Code would deprive or make it practically difficult for the applicant to achieve the same proportion of development potential commonly enjoyed by other properties in the same zoning district under the terms of this chapter. The hardship shall not be self-imposed.

Analysis: The literal interpretation of the provision of this Code would deprive or make it practically difficult for the applicant to achieve the same proportion of development potential commonly enjoyed by other properties in the same Zoning District under the terms of this Chapter. The locally designated historic boathouse has existed on the property for over 80 years. It represents an important piece of history, which is not able to be preserved under the terms of the current Water and Navigation Code, unless the property owners eliminate one of the two functional boat slips that exist at the property. Waterfront properties up and down the intracoastal waterway enjoy two boatlifts and/or wet slips at their property. As described above, the historic boathouse cannot functionally be used for a boat slip due to the 2018 addition of a covered boatlift directly to its north, rendering it virtually useless as a boat slip. The property owner should not be penalized for preserving a piece of history by not allowing them to enjoy and utilize the two existing places to permanently moor a boat associated with their dock.

(c) *Minimum code deviation necessary.* That the granting of the request is the minimum code deviation that will make possible the reasonable use of the land, building, or structure.

Analysis: The granting of this request is the minimum Code deviation that will make possible their reasonable use of the land, building or structure. The property owners are not requesting to do anything other than to allow what is currently there (and has all been permitted in the past by Pinellas County) to remain. Kelly Lee and Jack want to allow the locally designated historic structure to remain in its current form and current footprint. Therefore, this is the minimum Code deviation that will make possible the reasonable use of the structure and allow the historic roof and structure to be maintained.

(d) *Consistency with the land development code.* That the granting of the request will be in harmony with the general intent, purpose, and spirit of this Code.

Analysis: The granting of this request will be in harmony with the general intent, purpose and spirit of this Code. As discussed above, Kelly Lee and Jack are simply looking to enjoy the same rights afforded to everyone else under this Code, while

still preserving the historic 1940's boathouse. There is nothing contained in the Water and Navigation Regulations that suggests the intent of the Code was to eliminate historic structures or penalize property owners that seek to preserve historic structures on the water. The Water and Navigation Code does seek to protect all property owners' riparian rights, and the granting of this request will not interfere with the riparian rights of their neighbors, and will protect and preserve Kelly Lee and Jack's own riparian rights.

(e) *Consideration of rezoning.* That a rezoning of the property has been considered and determined not to be appropriate and/or determined not to meet the objective of the request.

Analysis: The criteria for consideration of rezoning is not applicable to this request.

(f) *Consistency with Comprehensive Plan.* That the granting of the request will be consistent with the intent and limits of the Comprehensive Plan.

Analysis: The granting of this request is consistent with the intent and limits of the Comprehensive Plan. As emphasized above, the historic boathouse has existed for over 80 years, and all other improvements that are currently on the property have been properly permitted through Pinellas County. Therefore, this variance request, which would allow the current marine structure to remain as is, would in no way compromise the County's goals for protecting coastal and marine habitats and dependent species, including manatees.

(g) *Detriment to public welfare.* That such request will not be injurious to the area involved or otherwise detrimental to the public welfare.

Analysis: Such request would not be injurious to the area involved or otherwise detrimental to the public welfare. As stated above, the setbacks from the existing structure to the neighboring property lines are greater than many of the neighbors' total waterfront property width. Granting the variance, to allow the existing structures to remain, does not interfere with the riparian rights of neighboring properties, and will not be injurious or detrimental to the public welfare. Rather, granting the variance would result in preserving a piece of history and would promote a popular understanding of history to the general public visiting the area.

(h) *Circumvent Board approval.* That the granting of the request does not circumvent a condition placed upon the subject property by the Board of Adjustment

and Appeals and/or the Board of County Commissioners. This shall not apply to new variances reviewed by the same board that originally placed the condition.

Analysis: This criteria does not apply to the subject application.

Local Government does its best to craft Land Development Regulations that apply uniformly throughout its jurisdiction, but there are always unique circumstances and properties that present challenges and opportunities for which the Codes need to be varied. I would submit this is the very type of situation for which variances are created. The subject property and application meets all of the criteria set forth by Pinellas County in its Code for the requested variance. Therefore, we respectfully request the Board of County Commissioners grant the request for a variance to Section 58-555(a)(5) or Section 58-543(m), and allow the existing structure, including the locally designated historic boathouse, to remain.

Very truly yours,

Lauren C. Rubenstein

Lauren C. Rubenstein

Enclosures

LCR/dh

7219.11012021.Variance App.wpd

EXHIBIT A

WATERWAY WIDTH: Over 500'

WATERSIDE WIDTH: 200'

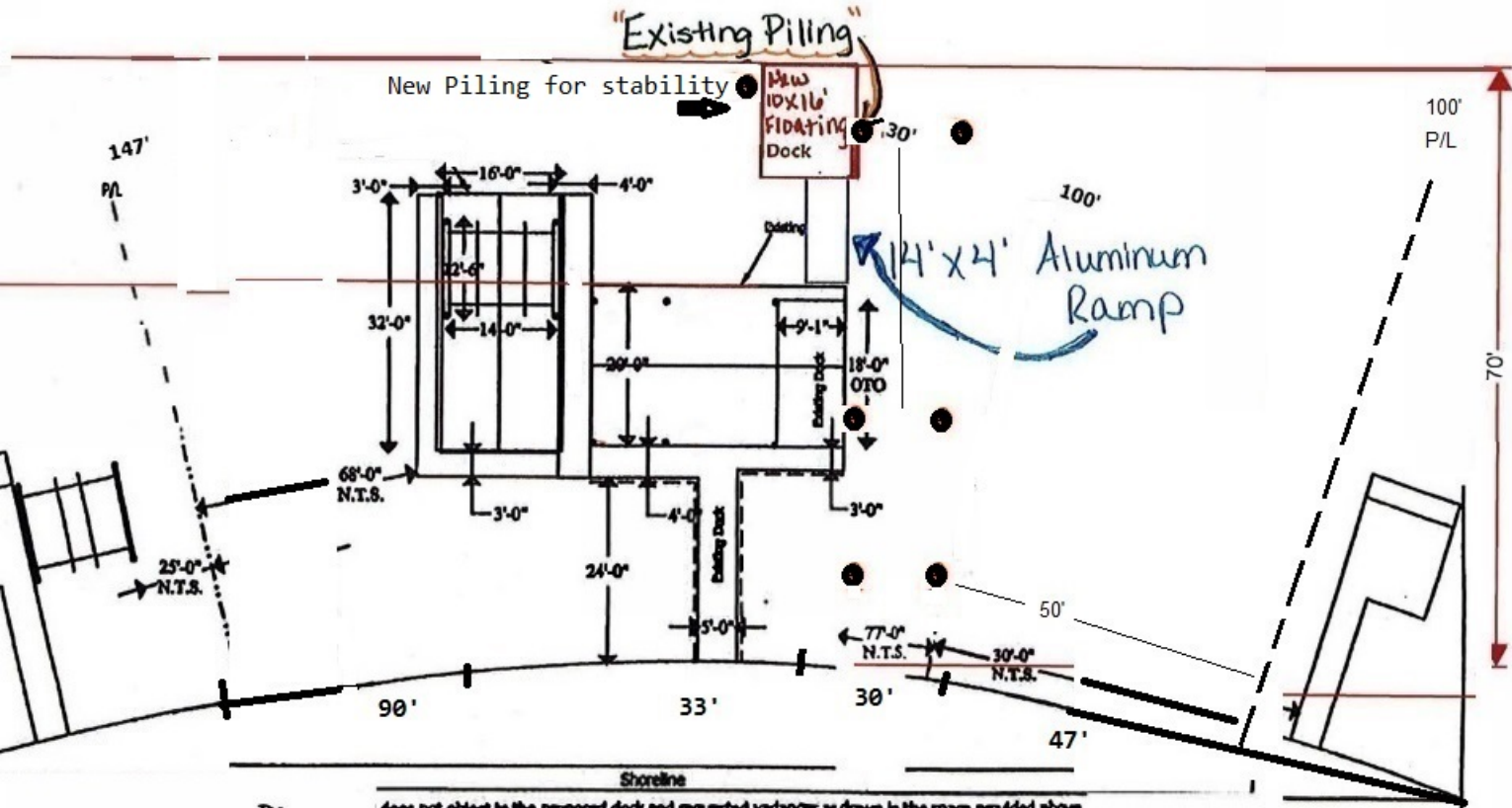

The
Left Owner

does not object to the proposed dock and requested variances as drawn in the space provided above.

Right Owner

Signature:

Date:

Signature:

EXHIBIT B



155 Corey Avenue St. Pete Beach, FL 33706 www.stpetebeach.org

11/05/2021

MCFREDERICK, KELLY L
3612 E MARITANA DR
ST PETE BEACH FL 33706-3919

Subject: Case # 21081

Property Location: 3612 E MARITANA DR ST PETE BEACH FL 33706
Parcel: 073216218520140060

At the 11/04/2021 hearing of the City of St. Pete Beach Historic Preservation Board, your request for a(n) local historic designation of existing covered dock was approved.

Section 3.14 of the LDC establishes the appeal process for any person or persons, jointly or severally, aggrieved by any decision of the Historic Preservation Board and all appeals must be filed within 30 days after rendition of the decision by the Historic Preservation Board.

If you have any questions on this case, do not hesitate to contact Planning and Zoning at (727-363-9253).

Respectfully,

Wesley T. Wright
Planning Manager

EXHIBIT C



EXHIBIT C

Looking North on Gulf Blvd. toward Belle Vista - ca 1941

EXHIBIT D



EXHIBIT D

COMPOSITE EXHIBIT E

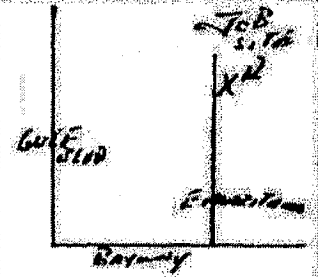
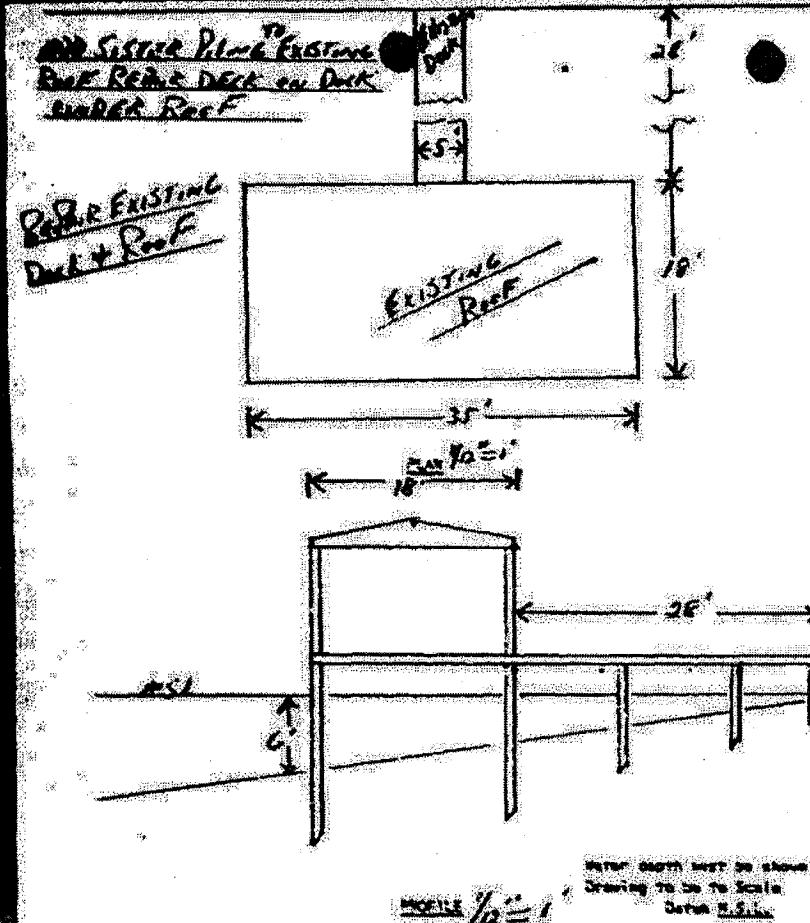

TICINITY MAP

FROM: U.S.G.S. MAP NO. 1

PROPERTY INFORMATION

LEGAL DESCRIPTION

LOT 5, V-6 GRAND BUCKLE / V

SUBDIVISION DUNEDON PL.

PLATBOOK 13 PAGE 15

SEC. 7 TO S. 28.16

Waterway Width: 675'

Waterfront Width: 275'

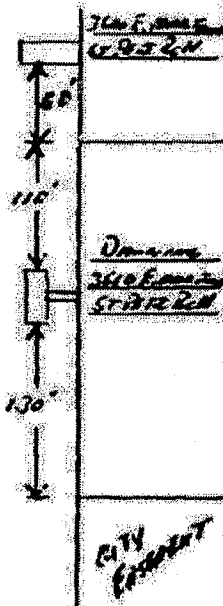

ORIGINAL SIGNATURE WITH NOTARY REQUIRED ON ALL VARIANCE APPLICATIONS

LEFT PROPERTY OWNER	RIGHT PROPERTY OWNER
SIGNATURE (Name)	SIGNATURE (Name)
ADDRESS	ADDRESS
Sworn to and subscribed before me this _____ day of _____	Sworn to and subscribed before me this _____ day of _____
NOTARY PUBLIC: _____ My Commission expires: _____	NOTARY PUBLIC: _____ My Commission expires: _____

WARRANTY

NAME: [Name] ADDRESS: [Address]

PROVIDED BY: [Name]

ENGINEER: [Name] DATE: [Date]

DOCK TO BE CONSTRUCTED IN COMPLIANCE WITH RULES AND REGULATIONS ADOPTED BY PINELLAS COUNTY WATER AND NAVIGATION CONTROL AUTHORITY, MOST RECENT REVISION.

SEE PLAN # 770

ADDITIONAL INFORMATION TO BE ATTACHED, AS REQUIRED.

W/R CLERK

PINELLAS COUNTY
Water & Navigation Control Authority
PERMIT NO. 15872-02

MUNICIPAL APPROVAL	PINELLAS COUNTY ENGINEERING DEPT. USE ONLY	
SUBJECT TO APPROVE By Pinellas County Water & Navigation Control Authority	PLAN APPROVAL	
	SIGNED [Signature] DATE: 10/13/12	

P 43094-13

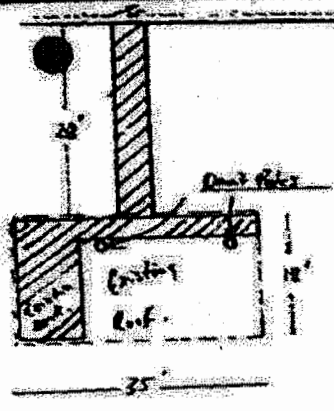

Sub P=20'

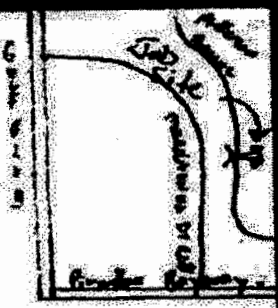

TICKET NO. _____
 FOR U.S.E. AND M.A.
 PROPERTY INFORMATION
 USE DESCRIPTION
 DIVISION OF _____
 DURATION: 1st. _____
 PERMITS
 NO. 7 10 21 25
 PROPERTY VALUE \$10,000
 PROPERTY AREA 2.75'

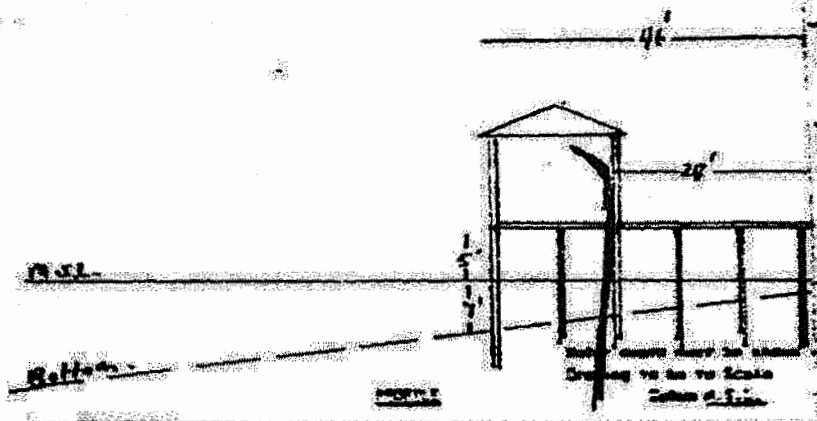

ORIGINAL SIGNATURE WITH NOTARY PUBLIC ON ALL VARIANCE APPLICATIONS

SIGNATURE (Owner)	SIGNATURE (Engineer)
ADDRESS	ADDRESS
DATE TO BE SUBMITTED BEFORE THE BOARD	DATE TO BE SUBMITTED BEFORE THE BOARD
NOTARY PUBLIC	NOTARY PUBLIC
THE COMMISSIONER'S ADDRESS	THE COMMISSIONER'S ADDRESS

PROVIDE A SET OF PLANS TO THE ADJACENT PROPERTY

PROJECT: DeBayle Marine
 ADDRESS: At Box 16775 State Rd 750 33726
 APPLICANT: Z.I. CCA
 EMPLOYER: _____
 PHONE: _____

WORK TO BE CONSTRUCTED IN COMPLIANCE WITH "RULES AND REGULATIONS" ADOPTED BY PINELLAS COUNTY WATER AND NAVIGATION CONTROL AUTHORITY. NOT REJECT REVISIONS.
 SEE AREA _____ OF _____ CONDITIONS INFORMATION TO BE ATTACHED, AS REQUIRED.

PINELLAS COUNTY
 Water & Navigation Control Authority
PERMIT NO. 118653-9
 FEDERAL/STATE PERMITS MAY BE REQUIRED FOR THIS PROJECT.
 APPLICATION FEES ARE NOT REFUNDABLE.

MUNICIPAL APPROVAL

PINELLAS COUNTY ENGINEERING DEPT. USE ONLY

APPROVED BY: AMM
 DATE: 8-6-91

PLAN APPROVAL
L. J. DeBate
 DATE: 8/6/91

EXHIBIT F

Attention: CONNOR
(Revised)

211 PINELLAS COUNTY
 Fax 453-3371

OK :)

PRIVATE DOCK

Application #

P43094-13/Rev
 (OFFICIAL USE ONLY)

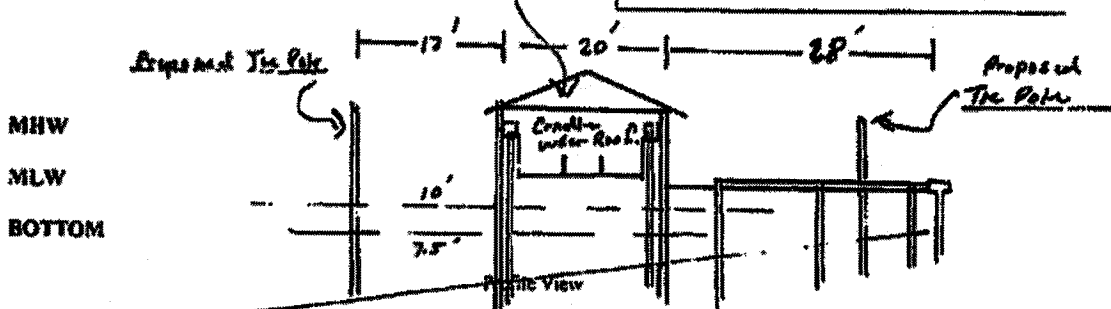

ENG. SCALE: 1" =



TOTAL SQUARE FEET 290 + Roof
 NEW SQUARE FEET 0
 WATERWAY WIDTH over 500
 WATERFRONT WIDTH 200.00

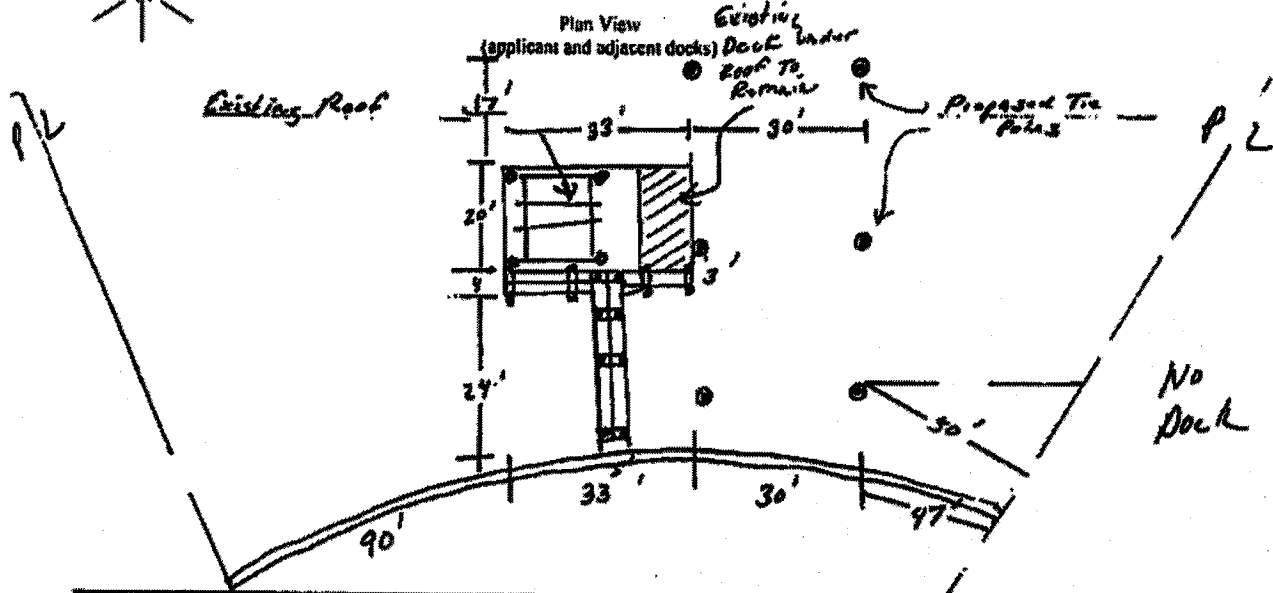

SHORELINE

The undersigned does not object to the proposed dock and requested variances as drawn in the space provided above.

Left Owner		Right Owner	
Signature	Date	Signature	Date
Municipality Approval		Water and Navigation Approval	

APPROVED
 PINELLAS COUNTY

8 30 2013 am

Chris Pato 9/3/13

Attention: Conner EM Pinellas County
 (Revised) Fax 453-3371 OK :)

PRIVATE DOCK

Application # **P43094-13/Rev**
 (OFFICIAL USE ONLY)

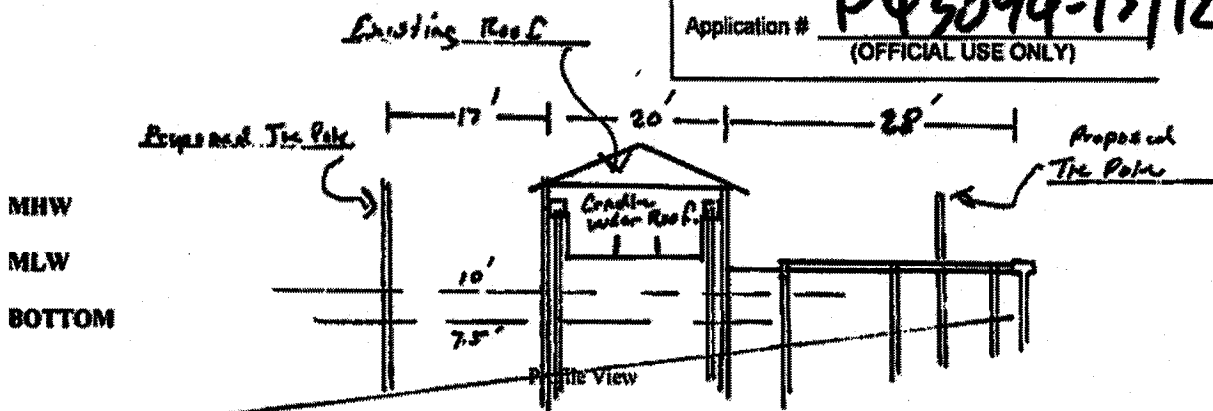

ENG. SCALE 1" = 10'



TOTAL SQUARE FEET 240 + Roof
 NEW SQUARE FEET 0
 WATERWAY WIDTH over 500
 WATERFRONT WIDTH 200.00

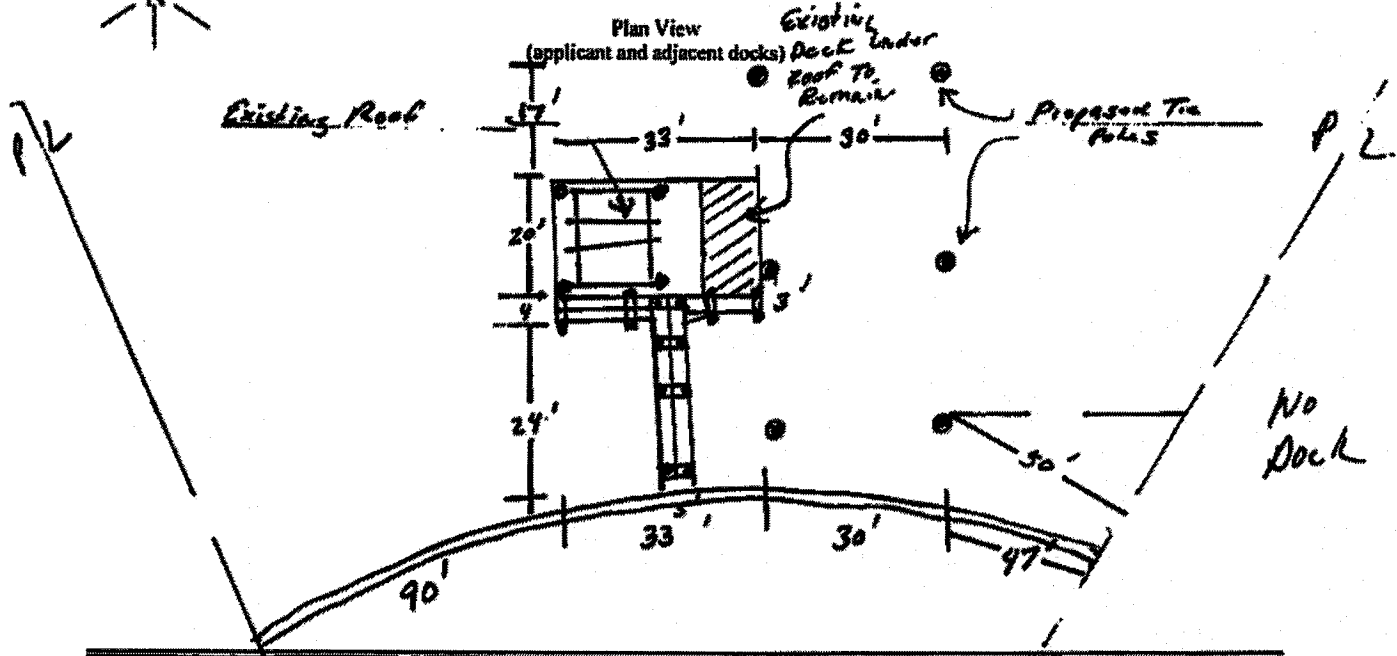

SHORELINE			
The undersigned does not object to the proposed dock and requested variances as drawn in the space provided above.			
Left Owner		Right Owner	
Signature	Date	Signature	Date
Municipality Approval		Water and Navigation Approval	

8.30.2013 am

Revised

Application # P43004-13/REV
(OFFICIAL USE ONLY)

IV. PROJECT DESCRIPTION:

A. Nature and Size of Project: Repair Existing Dock (5'x 25')
walk out w/(3'x 34)' TIC Head Covered Roof
To Remain. Install (6) New Tie Poles Square Feet: 227'

B. Variance: Yes No Remove Existing Davits & Install Small Lift
Amount in variance: Length: _____ Width: _____ under Existing Roof
Setbacks: Left: _____ Right: _____

Other: _____

NOTE: It is the applicant's responsibility to clearly demonstrate that any requested variances are consistent with the variance criteria of Section 166-291 of the Pinellas County Code. The applicant must demonstrate that a literal enforcement of the regulations would result in an extreme hardship due to the unique nature of the project and the applicant's property. The hardship must not be created by action(s) of the project owner(s). The granting of the variance must be in harmony with the general intent of the regulations and not infringe upon the property rights of others. The variance requested must be the minimum possible to allow for the reasonable use of the applicant's property. Should the applicant fail to demonstrate that any variance request is consistent with the criteria outlined in the regulations, staff cannot recommend approval of the application.

V. CONTRACTOR INFORMATION:

1. Gary DeBaylo, a certified contractor, state that the dock has not been constructed and that it will be built in compliance with all requirements and standards set forth in the Pinellas County Code, and in accordance with the attached drawings which accurately represent all the information required to be furnished. In the event that this dock is not built in accordance with the permit or the information furnished is not correct, I agree to either remove the dock or correct the deficiency.

Signed: [Signature] Cert No.: C-4202

Company Name: DeBaylo MARINE INC. Telephone No: 347-0234

City: St Pete Beach State: FL Zip: 33731

E-mail Address: DBAYLO MARINE INC @ Verizon. Net

VI. OWNER'S SIGNATURE:

I hereby apply for a permit to do the above work and state that the same will be done according to the map or plan attached hereto and made a part hereof, and agree to abide by the criteria of the Pinellas County Code for such construction and, if said construction is within the corporate limits of a municipality, to first secure approval from said municipality. I further state that said construction will be maintained in a safe condition at all times, should this application be approved, that I am the legal owner of the upland from which I herein propose to construct the improvements, and that the above stated agent/contractor may act as my representative. I understand that I, not Pinellas County, am responsible for the accuracy of the information provided as part of this application and that it is my responsibility to obtain any necessary permits and approvals applicable for the proposed activities on either private or sovereign owned submerged land.

7-23-13 Date [Signature] Legal Owner's Signature

PRIVATE DOCK

Application # P43094-13
(OFFICIAL USE ONLY)

MIW
MLW
BOTTOM

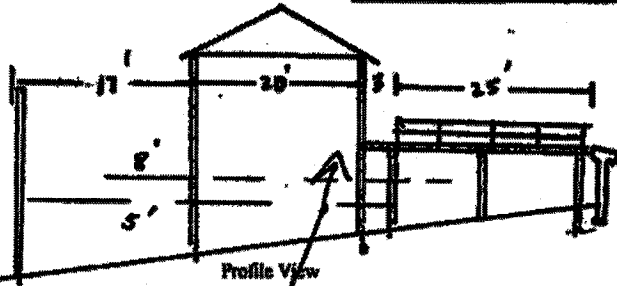

ENG. SCALE: 1" =



TOTAL SQUARE FEET 240' + Roof
NEW SQUARE FEET 0
WATERWAY WIDTH 100' 500'
WATERFRONT WIDTH 330'

Plan View
(applicant and adjacent docks)

What is under here?

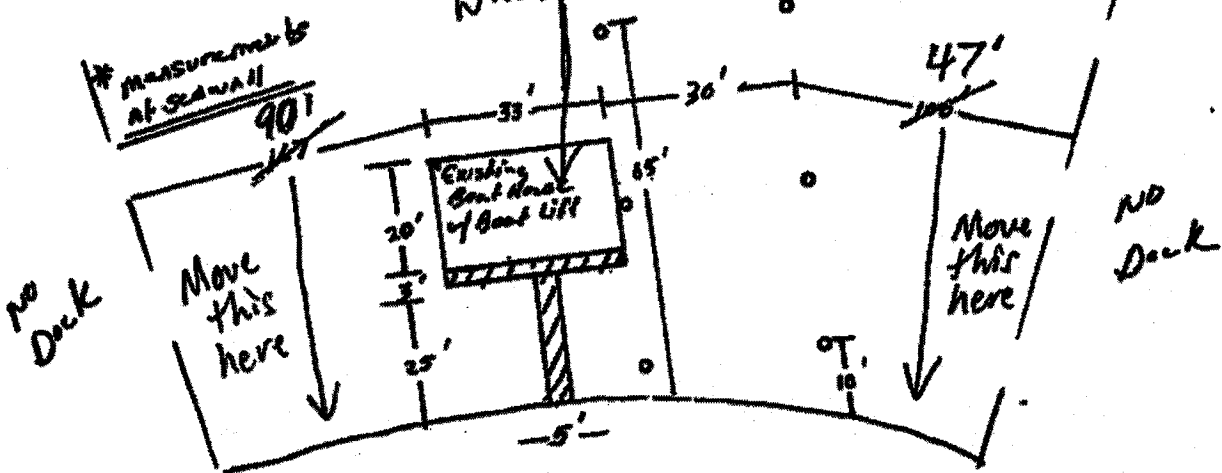

SHORELINE

The undersigned does not object to the proposed dock and requested variances as drawn in the space provided above.

Left Owner		Right Owner	
Signature	Date	Signature	Date
Municipality Approval		Water and Navigation Approval	

APPROVED
8.7.2013 am

Direct all correspondence to:

Clerk, Water and Navigation, 5th Floor
315 Court Street
Clearwater, FL 33756

Application # P 43094-13
(OFFICIAL USE ONLY)

\$450.00 # 16383

PRIVATE DOCK PERMIT APPLICATION

PINELLAS COUNTY WATER AND NAVIGATION

49679

I. PROPERTY OWNER INFORMATION:

- A. Applicant's Name: Ronald J Cooper
- B. Mailing Address: 3612 E MARITANA DRIVE
City: St Pete Beach State: FL Zip: 33706
- C. Telephone No: 727-804-6389 E-mail Address: Info @ Cooper Marine.com

II. AGENT INFORMATION:

- A. Name: DeByle Marine Inc.
- B. Address: P.O. Box 66495
City: St Pete Beach State: FL Zip: 33736
- C. Telephone No: 397-0234 E-mail Address: DeByleMarineInc@Verizon.net

III. SITE INFORMATION:

- A. Construction Site Address: 3612 E MARITANA DRIVE
City: St Pete Beach State: FL Zip: 33706
- B. Parcel ID Number: 0713216121852 101410660
- C. Incorporated: Unincorporated: St Pete Beach
- D. Affected Water Body: McPherson Canal
- E. Previous Permits: P1581788 P18653-91
- F. Date applicant assumed property ownership: Feb 2012 month/year
- G. Obstructions: (Dogs, Fences, etc.) none
- H. Attach 8 1/2" X 11" vicinity map showing specific project location.
- I. All other information pursuant to Section 166-328, Pinellas County Code, as needed.
- J. For projects requiring a public hearing, attach a copy of the complete legal description.

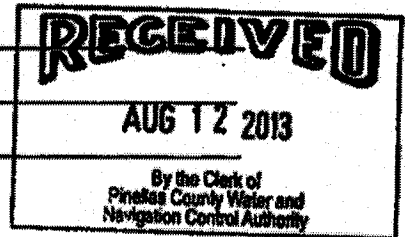

Application # P 43094-13
(OFFICIAL USE ONLY)

IV. PROJECT DESCRIPTION:

- A. Nature and Size of Project: Repair Existing Dock (5'x25')
walk out w/(3'x34)' TIC Head Covered Roof
To Remain. Install (6) New TIC Poles Square Feet: 227'
Add Boat Lift under Roof.
- B. Variance: Yes No
- Amount in variance: Length: _____ Width: _____
Setbacks: Left: _____ Right: _____

Other: _____

NOTE: It is the applicant's responsibility to clearly demonstrate that any requested variances are consistent with the variance criteria of Section 166-291 of the Pinellas County Code. The applicant must demonstrate that a literal enforcement of the regulations would result in an extreme hardship due to the unique nature of the project and the applicant's property. The hardship must not be created by action(s) of the project owner(s). The granting of the variance must be in harmony with the general intent of the regulations and not infringe upon the property rights of others. The variance requested must be the minimum possible to allow for the reasonable use of the applicant's property. Should the applicant fail to demonstrate that any variance request is consistent with the criteria outlined in the regulations, staff cannot recommend approval of the application.

V. CONTRACTOR INFORMATION:

I, Gary DeBaylo, a certified contractor, state that the dock has not been constructed and that it will be built in compliance with all requirements and standards set forth in the Pinellas County Code, and in accordance with the attached drawings which accurately represent all the information required to be furnished. In the event that this dock is not built in accordance with the permit or the information furnished is not correct, I agree to either remove the dock or correct the deficiency.

Signed: [Signature] Cert No.: C-4202

Company Name: DeBaylo Marine Inc. Telephone No: 347-0234

City: St Pete Beach State: FL Zip: 33731

E-mail Address: DBaylo@MARINEINC.COM Verizon.net

VI. OWNER'S SIGNATURE:

I hereby apply for a permit to do the above work and state that the same will be done according to the map or plan attached hereto and made a part hereof, and agree to abide by the criteria of the Pinellas County Code for such construction and, if said construction is within the corporate limits of a municipality, to first secure approval from said municipality. I further state that said construction will be maintained in a safe condition at all times, should this application be approved, that I am the legal owner of the upland from which I herein propose to construct the improvements, and that the above stated agent/contractor may act as my representative. I understand that I, not Pinellas County, am responsible for the accuracy of the information provided as part of this application and that it is my responsibility to obtain any necessary permits and approvals applicable for the proposed activities on either private or sovereign owned submerged land.

7-23-13 Date [Signature] Legal Owner's Signature

Application # P430A4-13
(OFFICIAL USE ONLY)

DISCLOSURE FORM

In order to alleviate any potential conflict of interest with Pinellas County staff, it is required that the County be provided with a listing of PERSONS being party to a trust, corporation, or partnership, as well as anyone who may have beneficial interest in the application which would be affected by any decision rendered by the County (attach additional sheets if necessary).

A. PROPERTY OWNERS:

Name: Ronald J Cooper Name: _____
Address: 3612 E. Mariposa Dr Address: _____
St. Pete Beach, FL 33706

Name: _____ Name: _____
Address: _____ Address: _____

B. REPRESENTATIVES:

Name: _____ Name: _____
Address: _____ Address: _____

Name: _____ Name: _____
Address: _____ Address: _____

C. OTHER PERSONS HAVING OWNERSHIP INTEREST IN THE SUBJECT PROPERTY:

Interest is: contingent absolute

Name: _____ specific interest held: _____

D. DOES A CONTRACT FOR SALE EXIST FOR THE SUBJECT PROPERTY? YES NO

If so, the contract is: contingent absolute

Name of parties to the contract: _____

E. DOES AN OPTION TO PURCHASE EXIST FOR THE SUBJECT PROPERTY? YES NO

Name of parties to the option: _____

F. OWNER'S SIGNATURE:

I hereby certify that the information stated above is complete, accurate, and true to the best of my knowledge.

X Ronald J Cooper Date 7-23-13

P43094-13

SECTION 7, TOWNSHIP #2 SOUTH, RANGE 18 EAST

A BOUNDARY SURVEY OF (PROVIDED TO SURVEYOR)



PARCEL "B"
 LOT 8, LESS THE SOUTHERLY 10 FEET THEREOF, BLOCK 14, DON CE-SAR PLACE, ACCORDING TO THE PLAT THEREOF, RECORDED IN PLAT BOOK W-13 AT PAGES 19 THROUGH 20, OF THE PUBLIC RECORDS OF PINELLAS COUNTY, FLORIDA, ALSO LESS AND EXCEPT LANDS DESCRIBED IN DEED RECORDED IN O.R. BOOK 10333, PAGE 182 OF SAID PUBLIC RECORDS.

PARCEL "B-1"
 BEING A PART OF THE 10 FOOT RESERVED SEAWALL AREA LYING EAST OF EAST MARTANA DRIVE RIGHT-OF-WAY, BEING ACROSS THE RIGHT-OF-WAY IN FRONT OF AND EASTLY OF LOT 8, BLOCK 14, DON CE-SAR PLACE, ACCORDING TO THE PLAT THEREOF RECORDED IN PLAT BOOK W-13 AT PAGES 19 THROUGH 20, OF THE PUBLIC RECORDS OF PINELLAS COUNTY, FLORIDA, BORDERED ON THE SOUTH BY A LINE AS THE EXTENSION OF THE NORTH BOUNDARY OF THE SOUTH 10 FEET OF SAID LOT 8 AND BORDERED ON THE NORTH BY A LINE AS THE EXTENSION OF THE SOUTHERLY BOUNDARY OF LESS OUT PORTION OF SAID LOT 8 DESCRIBED IN DEED RECORDED IN O.R. BOOK 10333, PAGE 182 OF SAID PUBLIC RECORDS.

BOUNDARY SURVEY ONLY - 2/03/12
 REVISED CERTIFICATION NAMES AND ADD UTILITIES - 2/13/12
 STAKED BUILDING ENVELOPE - 7/12/12
 FOUNDATION SURVEY - 8/07/12
 FINAL SURVEY - 12/11/12

CERTIFIED TO:
 RON COOPER AND JANE CARVER

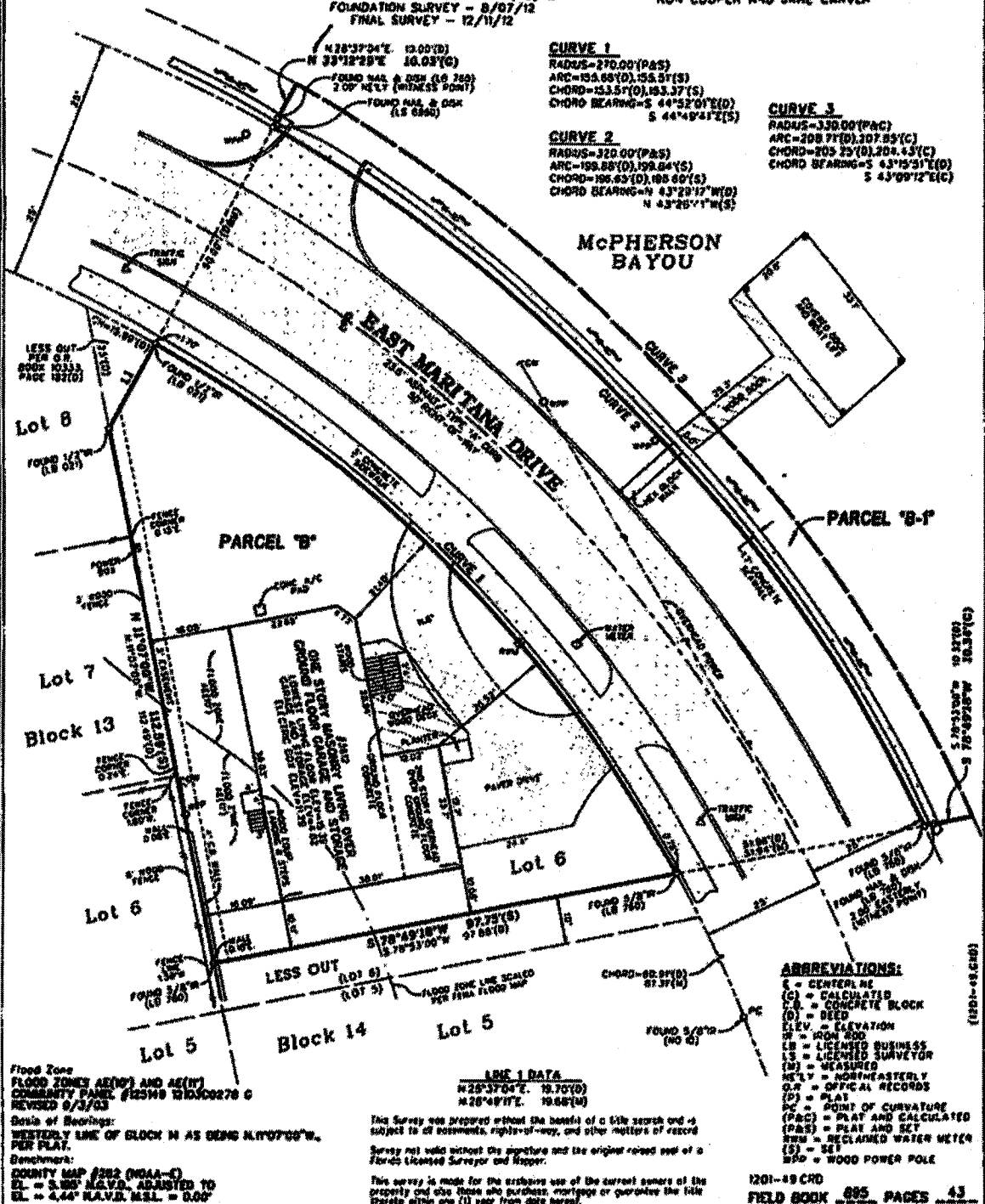

125
102

I hereby certify that the survey represented herein meets the requirements of Chapter 35-17.052, Florida Administrative Code.

JOHN C. BRENDLA
 Florida Surveyor's Registration No. 1269
 Certificate of Authorization No. 780

Prepared by:
JOHN C. BRENDLA & ASSOCIATES, INC.
 CONSULTING ENGINEERS AND LAND SURVEYORS
 4015 52nd Avenue North
 Pinellas Park, Florida 33781
 phone (727) 575-7548 - fax (727) 577-0082

COMPOSITE EXHIBIT G



COMPOSITE EXHIBIT G



EXHIBIT H

**PINELLAS COUNTY WATER & NAVIGATION
315 COURT STREET, CLEARWATER, FLORIDA 33756**

ISSUED TO: PRIORITY MARINE, LLC FOR LEONARD & LISA SIGNORILE
CONSTRUCTION SITE: 3612 EAST MARITANA DRIVE,
ST PETE BEACH, FL 33706
DESCRIPTION: 07-32-16-21852-014-0060

Permit is valid for 1 year
TO REPORT START DATE AND COMPLETION DATE, CALL: (727) 464-3770

PERMIT NO. P48100-18

1. PERMITS MAY ALSO BE REQUIRED FROM THE FOLLOWING AGENCIES: FL D.E.P & U.S. ARMY C.O.E.
2. THE WATERS OF PINELLAS COUNTY ARE LOCATED WITHIN THE PINELLAS COUNTY & BOCA CIEGA BAY AQUATIC PRESERVE. SPECIAL REGULATIONS EXIST THAT GOVERN THE CONSTRUCTION WITHIN AN AQUATIC PRESERVE. PLEASE CONTACT THE FL D.E.P.
3. *THIS PERMIT IS VALID FOR A DOCK STRUCTURE ONLY.* ELECTRICAL WATER/SEWER INSTALLATIONS WILL REQUIRE SEPARATE PERMITS FROM THE APPROPRIATE (Municipal or County) BUILDING DEPARTMENT.
4. THIS PERMIT IS SUBJECT TO A 30 DAY APPEAL PERIOD FROM DATE OF ISSUE- CHAPTER 31182, SPECIAL ACTS OF FLORIDA, 1955 AS REVISED.

CLERK:
KEN BURKE

By: *Janice Dewese*
Deputy Clerk

DATE OF ISSUANCE:

04-17-18

FINAL INSPECTION:

_____/_____/_____

**THIS PERMIT IS REQUIRED TO BE
POSTED IN A CONSPICUOUS LOCATION
AT THE CONSTRUCTION SITE.**

Direct all correspondence to:

Clerk, Water & Navigation, 5th Floor
315 Court Street
Clearwater, FL 33756

Application # P48100-18
(OFFICIAL USE ONLY)

5650 # 2771

PRIVATE DOCK PERMIT APPLICATION

(55859) **PINELLAS COUNTY WATER & NAVIGATION**

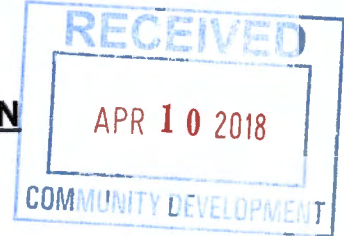

I. PROPERTY OWNER INFORMATION:

A. Applicant's Name: Leonard & Lisa Signorile
B. Mailing Address: 3612 E. Maritana Dr.
City: St. Pete Beach State: FL Zip: 33706-3919
C. Telephone No: 770.713.4924 E-Mail Address: lennyats@outlook.com

II. AGENT INFORMATION:

A. Name: Priority Marine
B. Address: 200 Midway Is
City: Clearwater State: FL Zip: 33767
C. Telephone No: 813.318.2811 E-Mail Address: Jason@prioritymarine.com

III. SITE INFORMATION:

A. Construction Site Address: 3612 E. Maritana Dr.
City: St. Pete Beach State: FL Zip: 33706-3919
B. Parcel ID Number: 07-32-16-21852-014-0060
C. Incorporated: Unincorporated: St. Pete Beach
D. Affected Water Body: McPherson Bayou
E. Previous Permits: P43094-13
F. Date applicant assumed property ownership: Aug./2016
month/year
G. Obstructions: (Dogs, Fences, etc.) None
H. Attach 8 1/2"x11" vicinity map showing specific project location.
I. All other information pursuant to Section 166-328, Pinellas County Code, as needed.
J. For projects requiring a public hearing, attach a copy of the complete legal description.

P48100-18

Application #

(OFFICIAL USE ONLY)

IV. PROJECT DESCRIPTION:

A. Nature & Size of Project: Build 4'x35' dock addition, 3' wide wrap around Catwalk, Install 16k Hi-Tide Gear Dr Boat Lift & build 16'x32' Gable roof

Square Feet: 530

B. Variance: Yes [] No [x]
Amounty in variance: Length: Width:
Left: Right:

Other:

NOTE: It is the applicant's responsibility to clearly demonstrate that any requested variances are consistent with the variance criteria of Section 166-291 of the Pinellas County Code. The applicant must demonstrate that a literal enforcement of the regulations would result in an extreme hardship due to the unique nature of the project and the applicant's property. The hardship must not be created by actions(s) of the project owner(s). The granting of the variancee must be in harmony with the general intent of the regulations and not infringe upon the property rights of others. The variance requested must be the minimum possible to allow for the reasonable use of the applicant's property. Should the applicant fail to demonstrate that any variance request is consistent with the criteria outlined in the regulations, staff cannot recommend approval of the application.

V. CONTRACTOR INFORMATION:

I, William Templeman, a certified contractor, state that the dock has not been constructed and that it will be built in compliance with all requirements and standards set forth in the Pinellas County Code, and in accordance with the attached drawings which accurately represent all the information required to be furnished. In the event that this dock is not built in accordance with the permit or the information furnished is not correct, I agree to either remove the dock or correct the deficiency.

Signed: [Signature] Cert No.: CGC1512989

Company Name Priority Marine Telephone No.: 727.447.1373

City: Clearwater State: FL Zip: 33767

Email Address: Bill@prioritymarine.com

VI. OWNER'S SIGNATURE:

I hereby apply for a permit to do the above work and state that the same will be done according to the map or plan attached hereto and made a part hereof, and agree to abide by the criteria of the Pinellas County Code for such construction and, if said construction is within the corporate limits of a municipality, to first secure approval from said municipality. I further state that said construction will be maintained in a safe condition at all times, should this application be approved, that I am the legal owner of the upland from which I herein propose to construct the improvements, and that the above stated agent/contractor may act as my representative. I understand that I, not Pinellas County, am responsible for the accuracy of the information provided as part of this application and that it is my responsibility to obtain any necessary permits and approvals applicable for the proposed activities on either private or sovereign owned submerged land.

3/30/2018 [x] [Signature]
Date Legal Owner's Signature

Priority Marine
 200 Midway Is
 Clearwater, FL 33767
 CGC1512989
 O: 727.447.1373 C: 813.318.2611
 Jason@prioritymarine.com
 www.prioritymarine.com

JOB: Leonard & Lisa Signorile
 3612 E. Maritana Dr.
 St. Pete Beach, FL 33706-3919
 770.713.4924

Date: April 9, 2018

Scale: 1" = 10'

P48100-18

Customers Approval Signature: _____

Total Square Feet 690 + roof.
 New Square Feet 290 + roof.
 Waterway Width 500'+
 Waterfront Width 200'

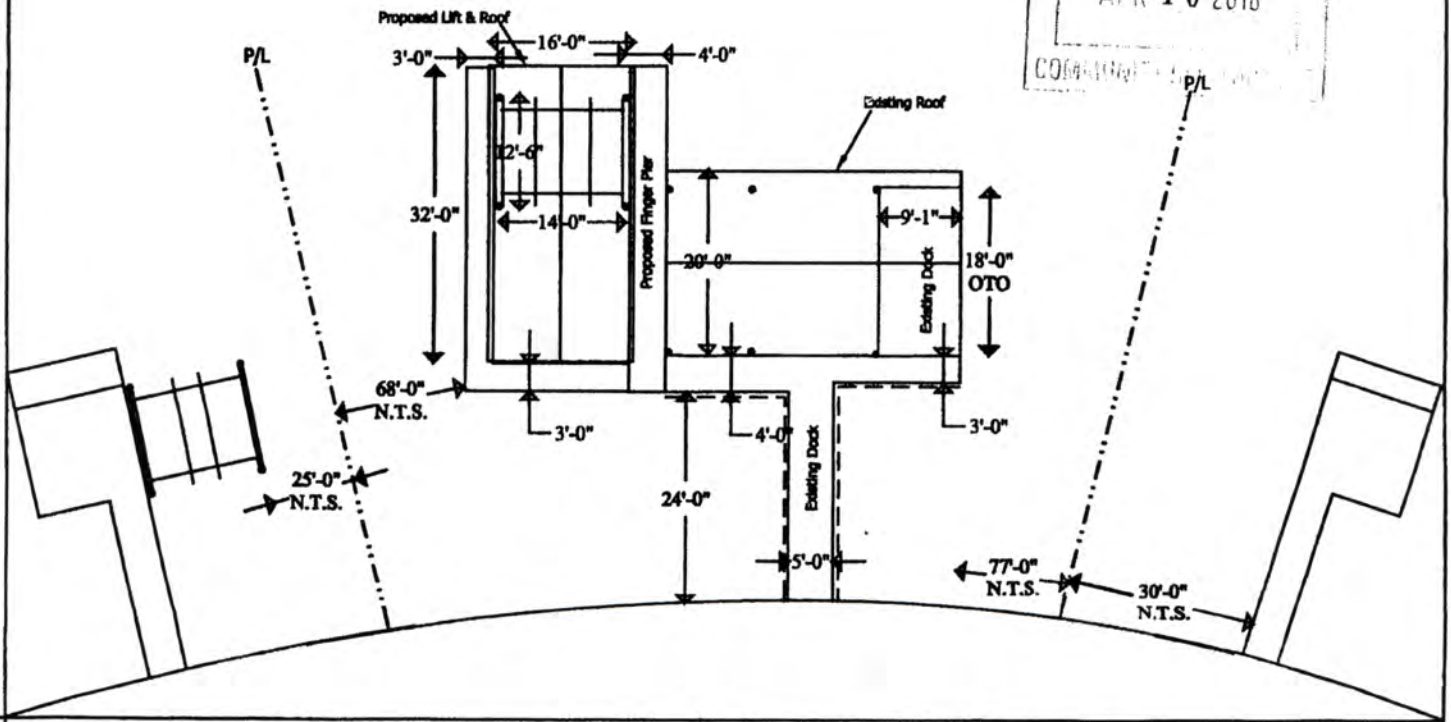
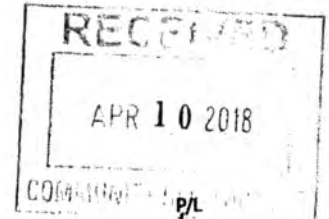
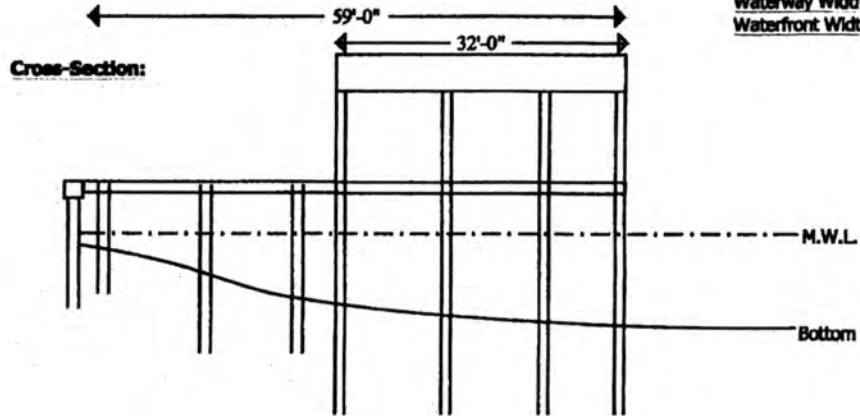

Shoreline

The undersigned does not object to the proposed dock and requested variances as drawn in the space provided above.

Left Owner

Right Owner

Signature:

Date:

Signature:

Date:

Municipality Approval

Water and Navigation Approval

APPROVED ZONING
 DATE Hetty Harmon 4/11/18
[Signature]

APPROVED
 PINELLAS COUNTY
 WATER AND NAVIGATION

[Signature]
4/17/18

Application # _____

(OFFICIAL USE ONLY)

DISCLOSURE FORM

In order to alleviate any potential conflict of interest with Pinellas County staff, it is required that the County be provided with a listing of PERSONS being party to a trust, corporation, or partnership, as well as anyone who may have beneficial interest in the application which would be affected by any decision rendered by the County (attach additional sheets if necessary).

A. PROPERTY OWNERS:

Name: Leonard & Lisa Signorile
Address: 3612 E. Maritana Dr.
St. Pete Beach, FL 33706-3919

Name: _____
Address: _____

Name: _____
Address: _____

Name: _____
Address: _____

B. REPRESENTATIVES:

Name: Priority Marine
Address: 200 Midway Is
Clearwater, FL 33767

Name: _____
Address: _____

Name: _____
Address: _____

Name: _____
Address: _____

C. OTHER PERSONS HAVING OWNERSHIP INTEREST IN THE SUBJECT PROPERTY:

Interest is: contingent absolute

Name: _____ specific interest held: _____

D. DOES A CONTRACT FOR SALE EXIST FOR THE SUBJECT PROPERTY? YES NO

If so, the contract is: contingent absolute

Name of parties to the contract: _____

E. DOES AN OPTION TO PURCHASE EXIST FOR THE SUBJECT PROPERTY? YES NO

Name of parties to the option: _____

F. OWNER'S SIGNATURE:

I hereby certify that the information stated above is complete, accurate, & true to the best of my knowledge

Leonard Signorile

Date: 3/30/2018

Attention: CONNOR Pinellas County
 (Revised) Fax 453-3371 OK :)

PRIVATE DOCK

Application # P43094-13/Rev
 (OFFICIAL USE ONLY)

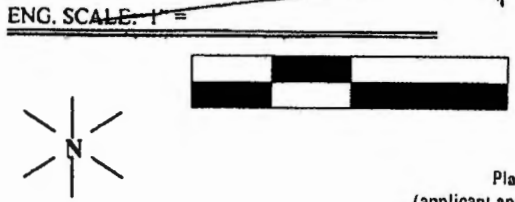
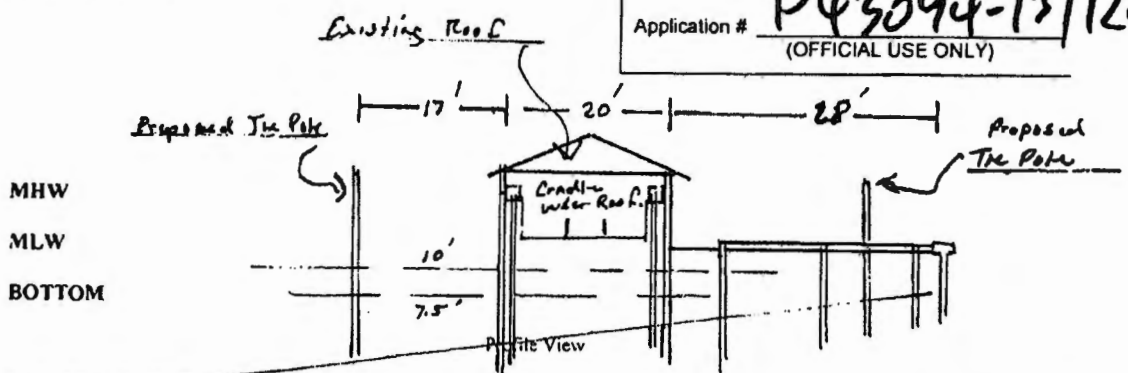

TOTAL SQUARE FEET 290 + Roof
 NEW SQUARE FEET 0
 WATERWAY WIDTH over 500
 WATERFRONT WIDTH 200.00

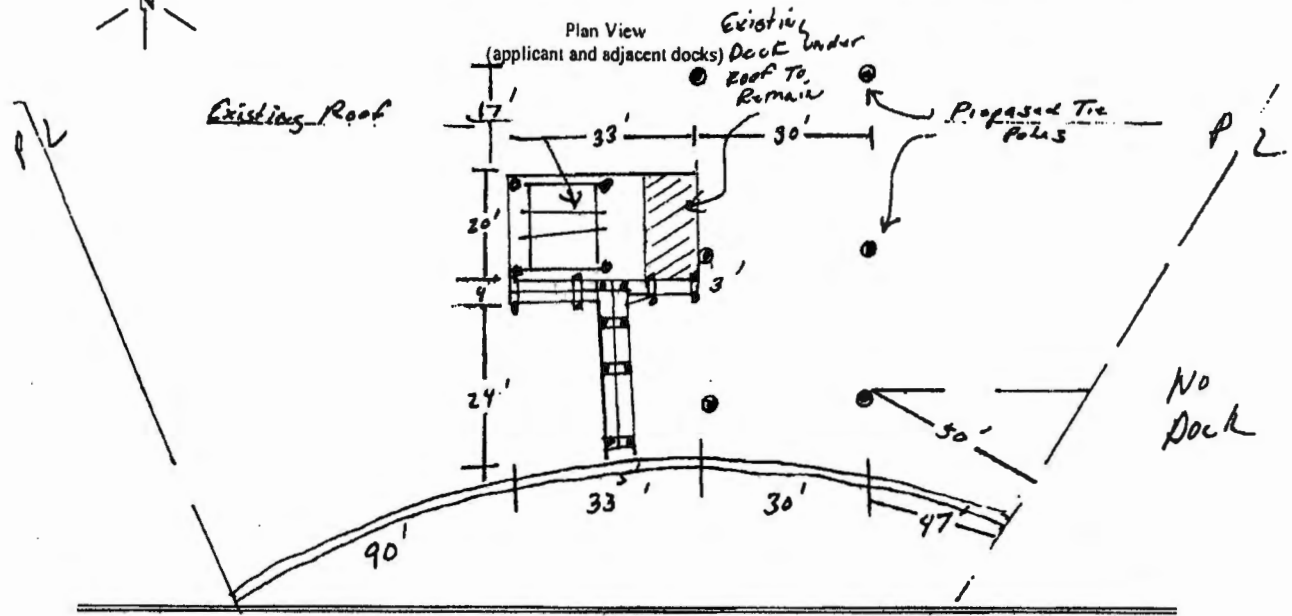

SHORELINE
 The undersigned does not object to the proposed dock and requested variances as drawn in the space provided above.

Left Owner		Right Owner	
Signature	Date	Signature	Date
Municipality Approval		Water and Navigation Approval	

APPROVED
 PINELLAS COUNTY
Connor 9/3/13

8 30 2013 am

COMPOSITE EXHIBIT I







EXHIBIT J

[Print](#) | [Close Window](#)

Subject: RE: FW: Dock at 3612 E Maritana Dr
From: "Mackesey, Brendan" <bmackesey@co.pinellas.fl.us>
Date: Fri, Jul 16, 2021 4:11 pm
To: "lauren@denhardtlaw.com" <lauren@denhardtlaw.com>
Attach: P43094-13.pdf
WND-H-48100-18.pdf
WND-21-00540.pdf
Visual Aid.pdf
FY21 User Fee Resolution.pdf

Hi Lauren:

This e-mail regards the outstanding Pinellas County Water & Navigation (WN) Private Dock Application No. 21-00540 (attached) for 3612 E. Maritana Drive, St. Pete Beach (the "2021 Application"). The upland property is owned by Kelly McFrederick and Jack Rice Jr., who you represent. As you are aware, WN Staff objects to several design elements of the 2021 Application. Accordingly, the County proposes several design revisions to the 2021 Application, which are outlined below. Using the sketch included in the 2021 Application, WN Staff created the attached Visual Aid; the numbers below should be cross-referenced with the Visual Aid.

1. WN Staff proposes removing the roof over the water and the existing 9.1' by 18' platform. As the roof will no longer be covering a boat slip, it will be inconsistent with (County) Code § 58-543(m) and consequently must be removed.
2. WN Staff proposes altering this area to prevent its use as a (third) boat slip. *See* Code § 58-555(a)(5) (two boat slips allowed per private dock). WN suggests placing a hand-railing along the red "U" shape.
3. WN Staff proposes reducing the width of this platform so that it constitutes a walkout. This walkout can be up to 5' wide, so only 4'1" needs to be removed. This will create a fixed walkout of 5' x 18' leading to the floating ramp of 4' x 14'.

(Numbers end.)

- The proposed 10' x 16' floating dock reflected in the 2021 Application (the "Floating Dock") may be installed. However, because floating docks are not contemplated by the minimum dock construction specifications outlined in Code § 58-544, an engineer must sign and seal a design of the Floating Dock. *See* Code §§ 58-539(c) (2) (authorizing deviations from construction standards based on engineering criteria) and 58-549(c) (authorizing requests for information prior to permit issuance).
- A five-times after-the-fact WN permit application fee must be paid. *See* Code § 58-540(b) (authorizing increased fees for after-the-fact WN permit applications) and the attached County FY21 User Fee Schedule, p. K-85 (authorizing a five-times fee for after-the-fact WN permit applications). The standard WN permit application fee is \$600, which has already paid; thus an additional \$2,400 is owed. Alternatively, the Floating Dock, as well as the tie poles permitted in Revised WN Permit No. P43094-13 (attached) (the "Tie Poles") may be removed and re-installed after issuance of a revised WN permit.

WN Staff understands that the Tie Poles were previously permitted. However, the Tie Poles are not reflected in WN Permit No. P48100-18 (attached) or the 2021 Application – which is contrary to Code § 58-550(e)(7)b.5. (private dock applications must show the locations of existing structures). Moreover, the Applicant commenced construction on the Floating Dock prior to WN permit issuance. It follows that a five-times after-the-fact WN permit application fee is justified on separate grounds.

WN Staff and I are hopeful that this matter can be resolve this matter amicably. I am available to discuss at your leisure.

Thanks again for your patience. Have a great weekend.

EXHIBIT J

Brendan Mackesey

Assistant County Attorney

Board Certified in City, County, and Local Government Law

Office: 727-464-3354

Cell: 703-919-3770

bmackesey@pinellascounty.org

All government correspondence is subject to the public records law.