

RESOLUTION NO. 21-__

A RESOLUTION OF THE PINELLAS COUNTY BOARD OF COUNTY COMMISSIONERS ADOPTING THE DOWNTOWN PALM HARBOR DESIGN GUIDELINES FOR USE IN THE IMPLEMENTATION OF THE DOWNTOWN PALM HARBOR FORM BASED CODE, CHAPTER 138, ARTICLE XII, PINELLAS COUNTY LAND DEVELOPMENT CODE AND THE DOWNTOWN PALM HARBOR HISTORIC DISTRICT PURSUANT TO CHAPTER 146, PINELLAS COUNTY LAND DEVELOPMENT CODE; AND PROVIDING AN EFFECTIVE DATE.

WHEREAS, the Pinellas County Board of County Commissioners has adopted Ordinance No. 21-__ creating the Downtown Palm Harbor Form Based Code as Article XII in Chapter 138 of the Pinellas County Land Development Code; and

WHEREAS, the Pinellas County Board of County Commissioners has adopted Resolution No. 21-__ amending the Pinellas County Zoning Atlas to include the Downtown Palm Harbor Form Based Code District; and

WHEREAS, the County seeks to assist property owners and other applicants in ensuring that new construction is compatible with the historical character of the contributing historic buildings in the Downtown Palm Harbor Historic District and buildings of historical merit as listed in the Downtown Palm Harbor Form Based Code District; and

WHEREAS, the County also seeks to assist property owners and other applicants in ensuring that new construction is consistent with the regulations and requirements set forth in Article XII, Downtown Palm Harbor Form Based Code, Chapter 138 of the Pinellas County Land Development Code; and

WHEREAS, Section 138-4503, Building Design Standards, Downtown Palm Harbor Form Based Code provides for the Board of County Commissioners to adopt design guidelines for the Downtown Palm Harbor Form Based Code to assist applicants in identifying appropriate architectural treatments for exterior remodels, renovations, additions, and new infill building projects; and

WHEREAS, Section 146-5(a)(6) of the Pinellas County Land Development Code includes among the powers and duties of the Pinellas County Historic Preservation Board, recommendation

to the Board of County Commissioners of specific design review criteria for special districts or overlay districts containing significant historic properties; and

WHEREAS, the Downtown Palm Harbor Historic District includes nine (9) contributing historic buildings as designated by the Board of County Commissioners; and

WHEREAS, the Pinellas County Historic Preservation Board has reviewed the Downtown Palm Harbor Design Guidelines and has recommended that the Board of County Commissioners adopt the attached design guidelines document for use in the administration of the Downtown Palm Harbor Historic District and the Downtown Palm Harbor Form Based Code.

NOW, THEREFORE, BE IT RESOLVED BY THE BOARD OF COUNTY COMMISSIONERS FOR PINELLAS COUNTY, FLORIDA, in regular session duly assembled this 24th day of August 2021, hereby affirms and ratifies the foregoing recitals and adopts the Downtown Palm Harbor Design Guidelines attached hereto as Exhibit "A".

This resolution shall become effective concurrently with the effective date established for Ordinance No. 21- __ creating the Downtown Palm Harbor Form Based Code as Article XII in Chapter 138 of the Pinellas County Land Development Code.

Commissioner _____ offered the foregoing Resolution and moved its adoption, which was seconded by Commissioner _____, and upon roll call the vote was:

AYES:

NAYS:

Absent and not voting:

APPROVED AS TO FORM
By: David S. Sadowsky
Office of the County Attorney



DOWNTOWN PALM HARBOR DESIGN GUIDELINES

TO BE USED WITH THE DOWNTOWN PALM HARBOR FORM BASED CODE

EXHIBIT A

THESE GUIDELINES WERE PREPARED BY:
PINELLAS COUNTY
HOUSING AND COMMUNITY DEVELOPMENT DEPARTMENT



CONTENTS

INTRODUCTION	4
I. BUILDING FORMS	7
II. FAÇADE FENESTRATION	18
III. MASSING REDUCTION TECHNIQUES	20
IV. STOREFRONTS	22
V. WINDOWS & DOORS	24
VI. MATERIALS	26

INTRODUCTION

The architectural character of the *Contributing Properties* designated under Chapter 146, Pinellas County Land Development Code and *Buildings of Historical Merit* as identified in the Downtown Palm Harbor Form Based Code (DPH-FBC) under [Section 138-4502: Downtown Palm Harbor Historic Properties](#), are the source and inspiration for proposed infill building in the district. The intent of this document is to provide additional detailed guidance for proposed projects in a manner consistent with the standards and requirements set forth in the Pinellas County Land Development Code.

Buildings in Downtown Palm Harbor are included under one of the following three categories:

Designated Historic Buildings

The following historic buildings in Downtown Palm Harbor have been designated as a Contributing Property as per [Chapter 146, Pinellas County Land Development Code](#) and as depicted on the [DPH-FBC District Map, Figure 138-4401.a](#):

BUILDING NAME AND LOCATION	YEAR BUILT/MODIFIED
The Bank Building, 1026 Florida Avenue	1921
Doud's 2nd Barber Shop, 1122 Florida Avenue	1935
Sutherland Masonic Lodge, 1123 Florida Avenue	Circa 1890/1930
Doud's 1st Barber Shop, 1126 Florida Avenue	1945
Durrance Building, 1219 Florida Avenue	Circa 1900/1946
Hill's General Store, 1017 Omaha Circle	1896
Van Valkenberg House, 1202 Nebraska Avenue	1940
ME Church (White Chapel), 1190 Georgia Avenue	1924
First Library, 1205 Omaha Circle	1946

For rehabilitation work on the exterior of a **Designated Historic Building**, or construction of a new primary building or accessory structure on a **Contributing Property**, the issuance of a **Certificate of Appropriateness** is required consistent with the standards and procedures outlined in [Section 146-7, Pinellas County Land Development Code](#).

Buildings of Historical Merit

The following buildings in Downtown Palm Harbor have been identified as a *Building of Historical Merit* as per [Section 138-4502, Pinellas County Land Development Code](#) and as shown on the [DPH-FBC District Map, Figure 138-4401.a](#):

LOCATION	YEAR BUILT/MODIFIED
816 11th Street	1925
875 12th Street	Circa 1925/1955
909 Florida Avenue	1905
1106 Michigan Avenue	1920
1112 Michigan Avenue	1939
1069 12th Street	1932

For any proposed demolition that effects the exterior of a **Building of Historical Merit**, the **Certificate of Appropriateness** standards, requirements, and procedures for demolition outlined in [Section 146-7\(b\)\(1\), Pinellas County Land Development Code](#) must be followed.

For all other projects involving exterior work or new construction, the standards, requirements, and procedures outlined in [Division 5 of the DPH-FBC](#) are applicable.

Non-historic Buildings

New and infill construction in the Downtown Palm Harbor Historic District is welcome and encouraged. Because rhythm, balance, and proportion are critical elements in an architectural composition, it is important that applicants understand and employ these principles when planning and designing additions to existing buildings and new infill construction. By following these principles, a project is more likely to achieve compatibility with the historic context of the district. New buildings should conform to the established rhythms of the streetscape, reflect the overall development pattern and setbacks of surrounding buildings and use materials that match and/or complement those on historic buildings. These guidelines attempt to provide opportunity for architectural variety in new construction but in a manner harmonious with the form, scale, massing, and materials of surrounding historic buildings.

Any building in the greater Downtown Palm Harbor area as depicted on the [DPH-FBC District Map, Figure 138-4401.a](#) that is not a **Designated Historic Building** on a **Contributing Property** nor is identified as a **Building of Historical Merit**, shall be deemed a **Non-Historic Building** and must conform to the standards, requirements, and procedures outlined in [Division 5 of the DPH-FBC](#) with guidelines provided below.

I. BUILDING FORMS

BUILDING DESIGN STANDARDS: NEW & INFILL DEVELOPMENT

DPH FBC DIV. 5: 138-4503 (d)(3)c

This page left intentionally blank

A. FRONT - PARAPET FORM

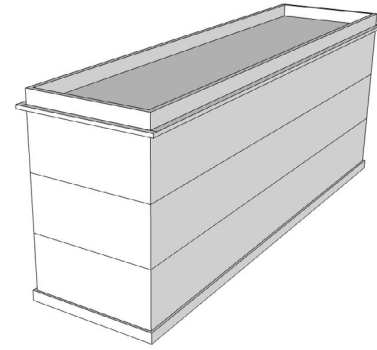

b. Main roof:

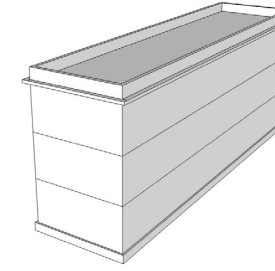

Flat or shed roof behind parapet

c. Parapet configuration - typical parapet types shown below:

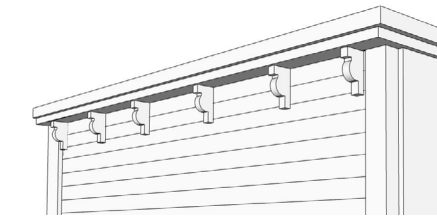

Flat top with corbels

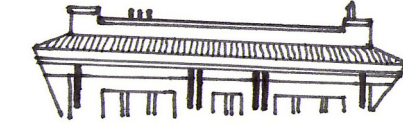

Flat top with pent

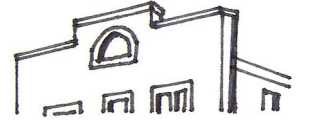

Stepped top

1. HISTORIC DISTRICT PRECEDENTS



Hill Building, 1017 Omaha Circle



The Bank Building, 1026 Florida Avenue



Craver's General Store



Doud's 2nd Shop, 1126 Florida Avenue

2. MASSING & ROOF

a. Façade rank configuration - typical configurations shown below:

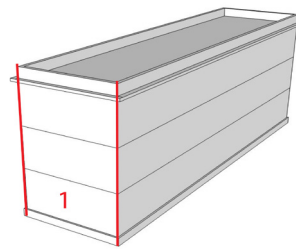

Narrow front, 1 rank wide

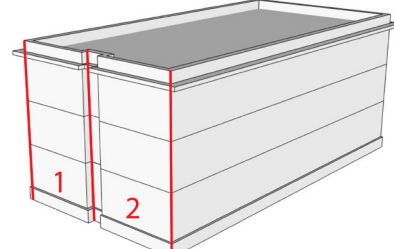

Four-square, 2 ranks wide

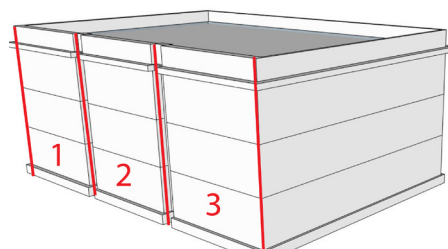

Broad front, 3 ranks wide

For proposed 3-story, multi-rank buildings, see Massing Reduction Techniques on page 21.

3. FAÇADE CONFIGURATION

a. First floor treatment - a storefront should be provided for each façade rank. (See page 23 for storefront architectural details.)

b. Primary entrance - one of the following entrance types should be provided on each storefront:

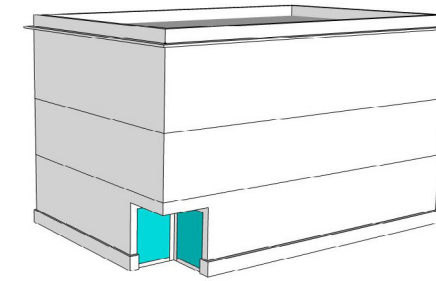

Recessed corner entrance with single leaf door

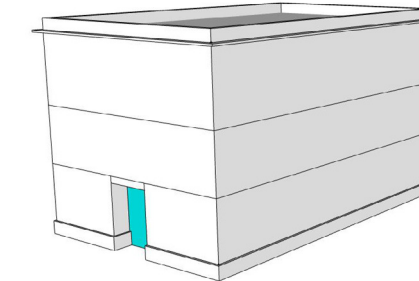

Recessed center entrance with double leaf door

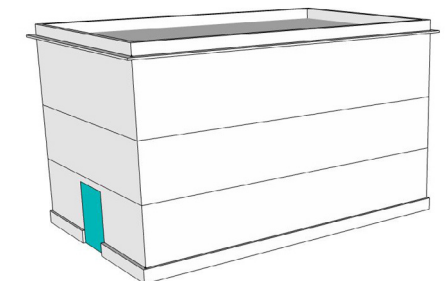

Flush center entrance with double leaf door

c. Projections - one or more of the following façade projections should be provided on each storefront:

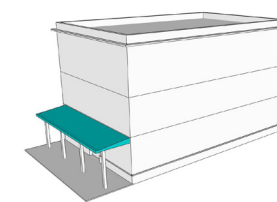

1-Story gallery

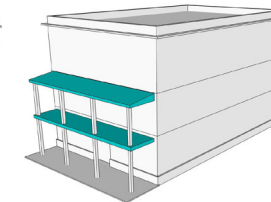

2-Story gallery

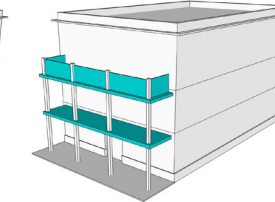

2-Story gallery with deck

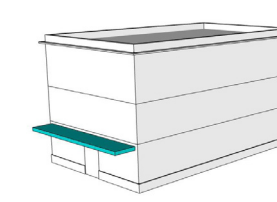

Awnings or canopy, Entire storefront

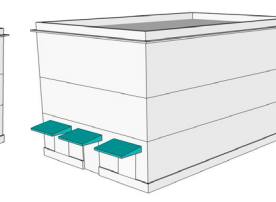

Awnings or canopy, Entrance & windows

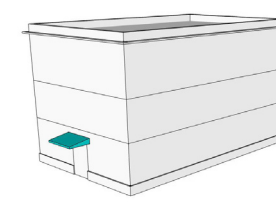

Awnings or canopy, Entrance only

B. FRONT-GABLE FORM

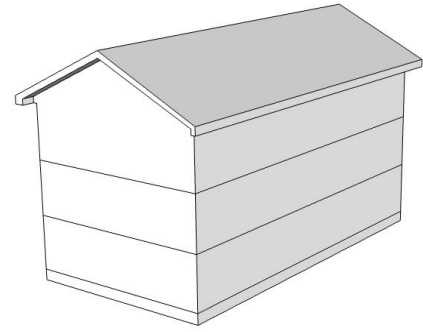

b. Main roof:



Gable end faces the street

c. Roof pitch:

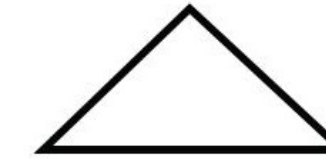

10:12



8:12



6:12

1. HISTORIC DISTRICT PRECEDENTS



Former Masonic Lodge, 1123 Florida Avenue



Van Valkenburg House, 1202 Nebraska Avenue



Doud's 2nd Shop, 1122 Florida Avenue

2. MASSING & ROOF

a. Façade rank configuration - typical configurations shown below:

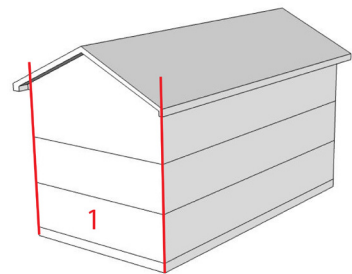

Narrow front, 1 rank wide

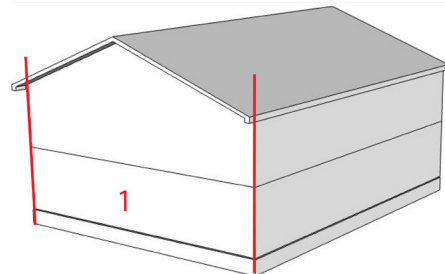

Broad front, 1 rank wide

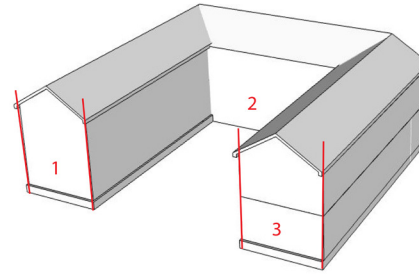

Narrow fronts (U-Plan), 3 ranks wide

3. FAÇADE CONFIGURATION

a. First floor treatment:

- Storefront - a storefront may be used on any first floor façade rank containing a nonresidential use. (See page 23 for storefront architectural details.)
- Non-storefront - fenestration should be consistent among all floors, as depicted on page 19 and the first floor should be differentiated from upper floors through a change in materials, greater height, and a coping/cornice installed between floors.

b. Primary Entrance - a primary entrance should be provided on each storefront. (See examples under Section I.A.3.b, page 9.)

c. Projections - a façade projection should be provided on each storefront. (See examples under Section I.A.3.c, page 9.)

C. GABLE & TOWER FORM

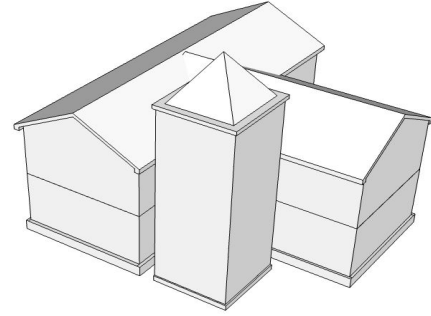

1. HISTORIC DISTRICT PRECEDENTS



White Chapel, 1190 Georgia Avenue



Hotel San Marino (demolished)

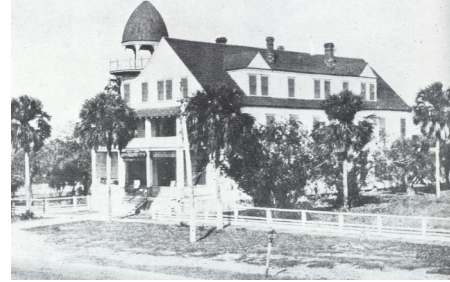

Gulf View Hotel (demolished)

2. MASSING & ROOF

a. Façade rank configuration - typical configurations shown below:

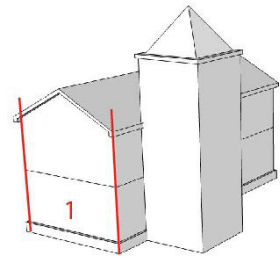

Front-gable, 1 rank wide

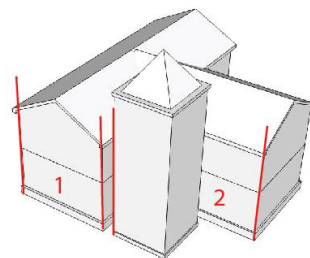

Cross-gable, 2 ranks wide

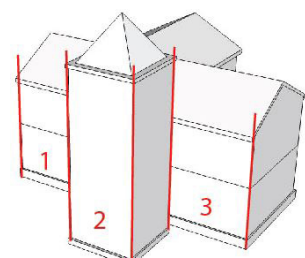

Cross-gable, 3 ranks wide

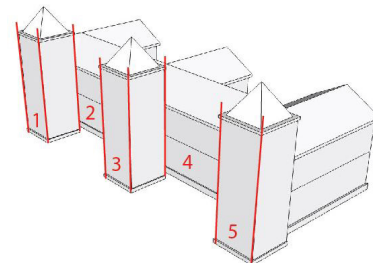

Mutli-gable, 5 ranks wide

b. Roof pitch:

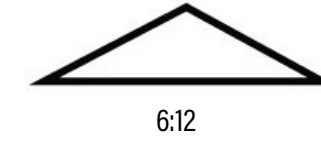
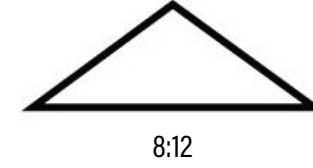
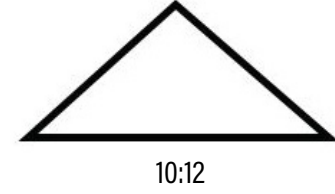

c. Dormer types (optional):

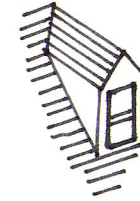

Gabled roof

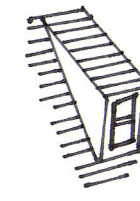

Shed roof

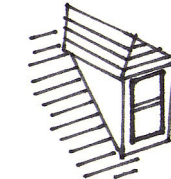

Hipped roof

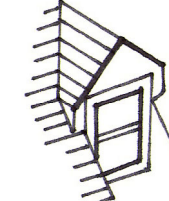

Inset

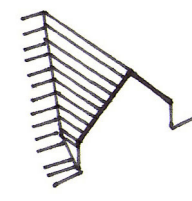

Wall

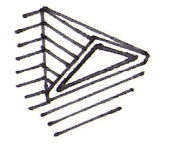

Eyebrow

3. FAÇADE CONFIGURATION

a. First floor treatment:

- Storefront - a storefront may be used on any first floor façade rank containing a nonresidential use. (See page 23 for storefront architectural details.)
- Non-storefront - fenestration should be consistent among all floors, as depicted on page 19, and the first floor should be differentiated from upper floors through a change in materials, greater height, and a coping/cornice installed between floors.

b. Primary Entrance - a recessed entrance should be provided at the base of the tower or use the entrance types shown in Section I.A.3.b, page 9.

c. Projections - A projecting gallery porch may be used as a projection on one or more façade ranks. (See examples under Section I.A.3.c, page 9.)

D. CROSS-GABLE & SIDE-GABLE FORM

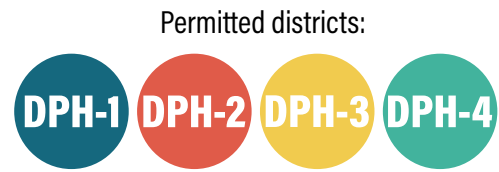
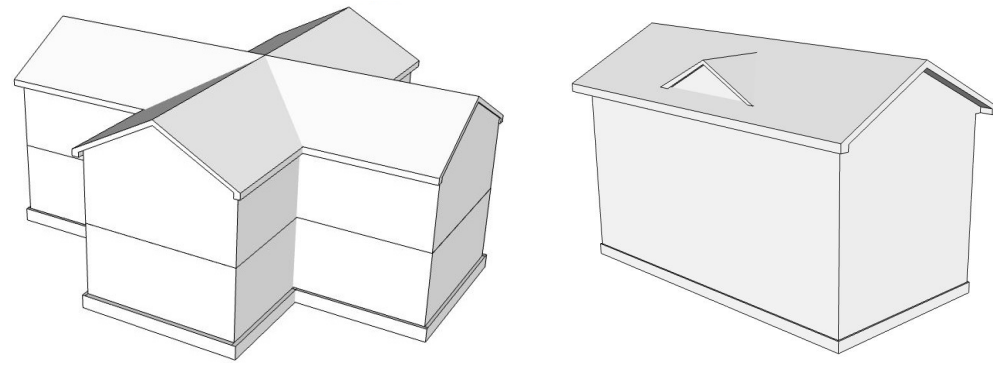

1. HISTORIC DISTRICT PRECEDENTS



Durrance Building, 1219 Florida Avenue



1069 12th Street

2. MASSING & ROOF

a. Façade rank configuration - typical configurations shown below:

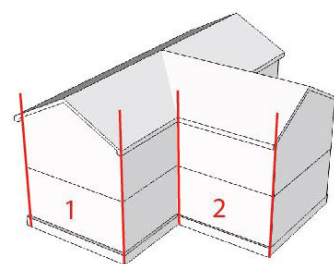

Cross-gable, 2 ranks wide

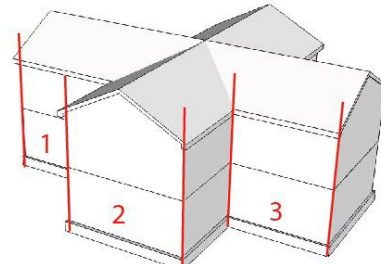

Cross-gable, 3 ranks wide

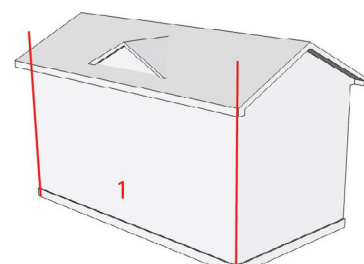

Side-gable, 1 rank wide

b. Roof pitch:

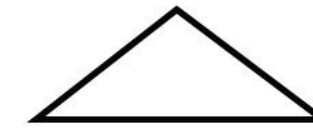

10:12



8:12

c. Dormer types (optional):



Gabled roof

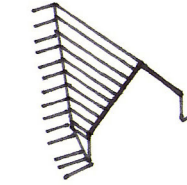

Wall

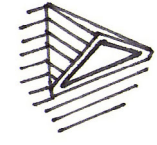

Eyebrow

3. FAÇADE CONFIGURATION

a. First floor treatment:

- Storefront - a storefront may be used on any façade rank containing a nonresidential use. (See page 23 for storefront architectural details.)
- Non-storefront - fenestration should be consistent among all floors, as depicted on page 19, and the first floor should be differentiated from upper floors through a change in materials, greater height, and a coping/cornice installed between floors.

b. Primary Entrance - a recessed entrance or flush entrance should be provided using the entrance types shown in Section I.A.3.b, page 9.

c. Projections - select one from the types below, unless providing a recessed entrance:

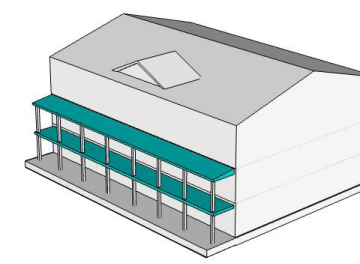

Projecting gallery (full width)

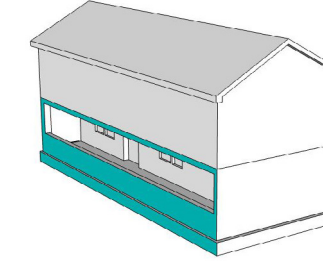

Integrated porch

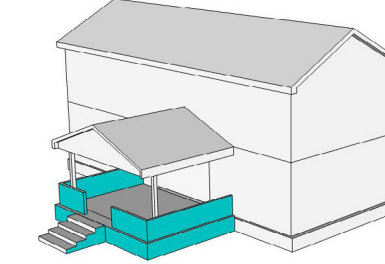

Projecting entrance porch

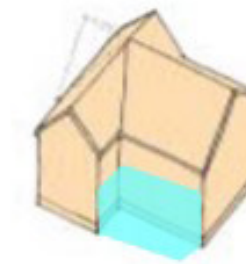

Rank-width porch

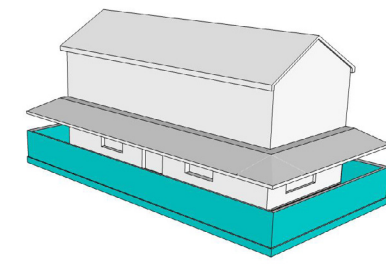

Wrap-around porch

E. HIPPED FORMS (PYRAMIDAL, CLIPPED & GABLE-ON-HIP)

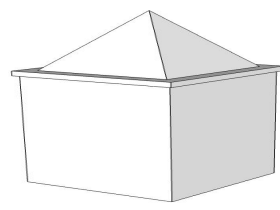

Pyramidal

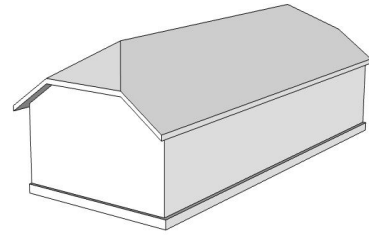

Clipped Gable

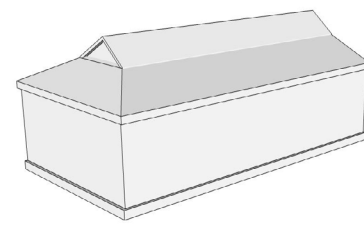

Gable-on-Hip

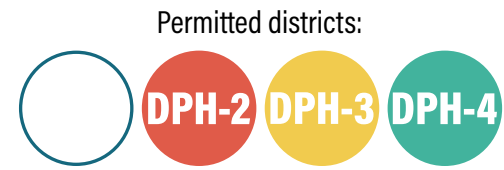

1. HISTORIC DISTRICT PRECEDENTS

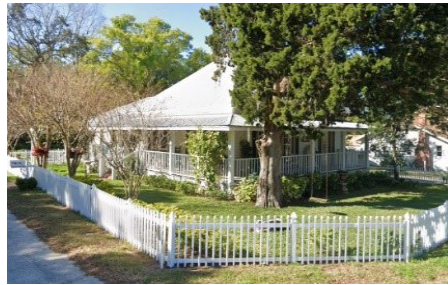

875 12th Street



1112 Michigan Avenue

2. MASSING & ROOF

a. Façade rank configuration for this form shown under I.D.2.a, page 14.

b. Roof pitch:

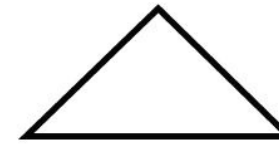

12:12

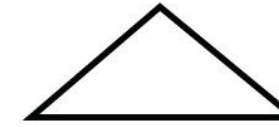

10:12



8:12



6:12

3. FAÇADE CONFIGURATION

a. First floor treatment:

- Storefronts - should not be used on these building forms.
- Non-storefronts - fenestration should be consistent among all floors as depicted on page 19.

b. Primary Entrance - a recessed entrance (Gable-on-hip only) or flush entrance should be provided.

c. Projections - see options available on page 15.

II. FAÇADE FENESTRATION

A. SYMMETRICAL FENESTRATION WITH ALIGNED BAYS FROM FLOOR-TO-FLOOR (FRONT-PARAPET)

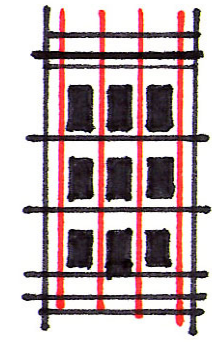

1 Rank with 3 Bays

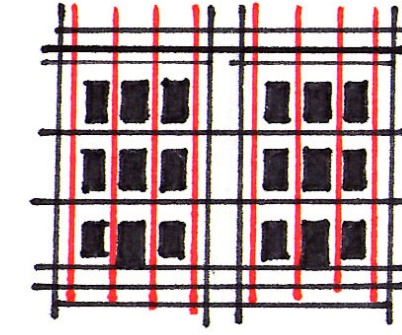

2 Ranks with 3 Bays per Rank

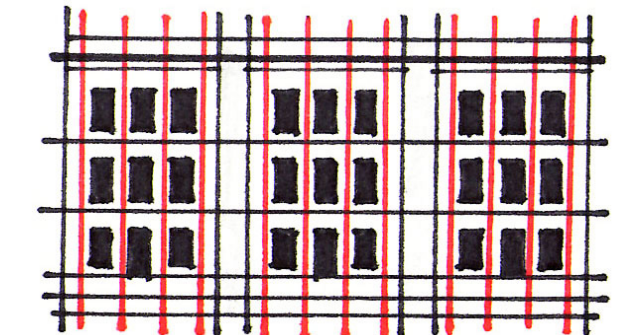

3 Ranks with 3 Bays per Rank

B. SYMMETRICAL OR ASYMMETRICAL FENESTRATION WITH ALIGNED BAYS FROM FLOOR-TO-FLOOR (FRONT-GABLE; GABLE & TOWER; CROSS GABLE)

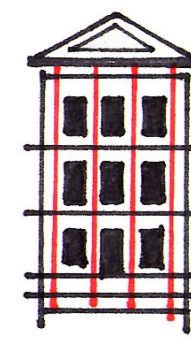

Symmetrical,
1 Rank with 3 Bays

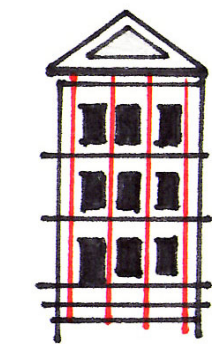

Asymmetrical 1st Floor,
1 Rank with 3 Bays

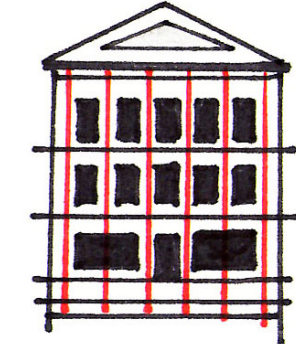

Symmetrical,
1 Rank with 5 Bays

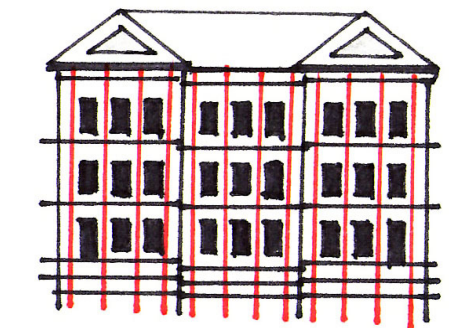

Symmetrical,
3 Ranks with 3 Bays per Rank

III. MASSING REDUCTION TECHNIQUES

If the size of the proposed infill building is considerably larger than nearby contributing historic structures and the overall character of the vicinity, the techniques on this page may be used to mitigate the adverse impact of the new building's size and massing. In some cases, it may be necessary to combine treatments to improve a large building's compatibility with smaller scale of adjacent buildings.

A. ARTICULATION ON FACADE BETWEEN RANKS

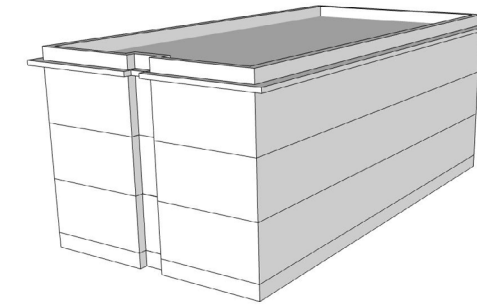

C. BREAK IN ROOFLINE

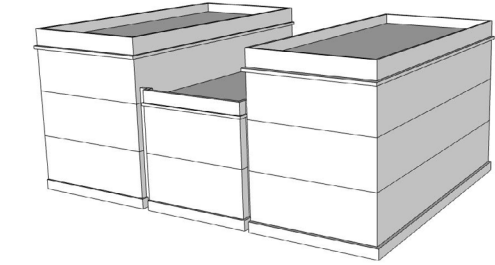

B. STEPPED-BACK UPPER STORY

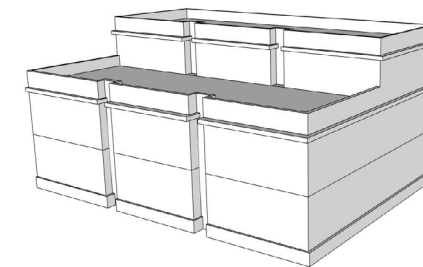

D. ADDITIVE MASSING

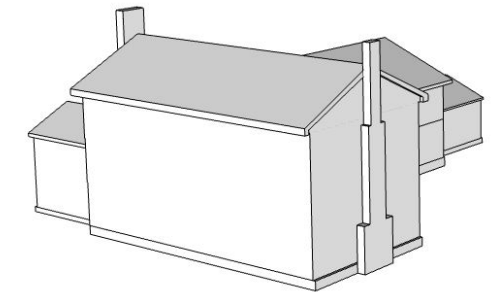

IV. STOREFRONTS

A. STOREFRONT COMPONENTS (INCLUDE ALL ELEMENTS BELOW)

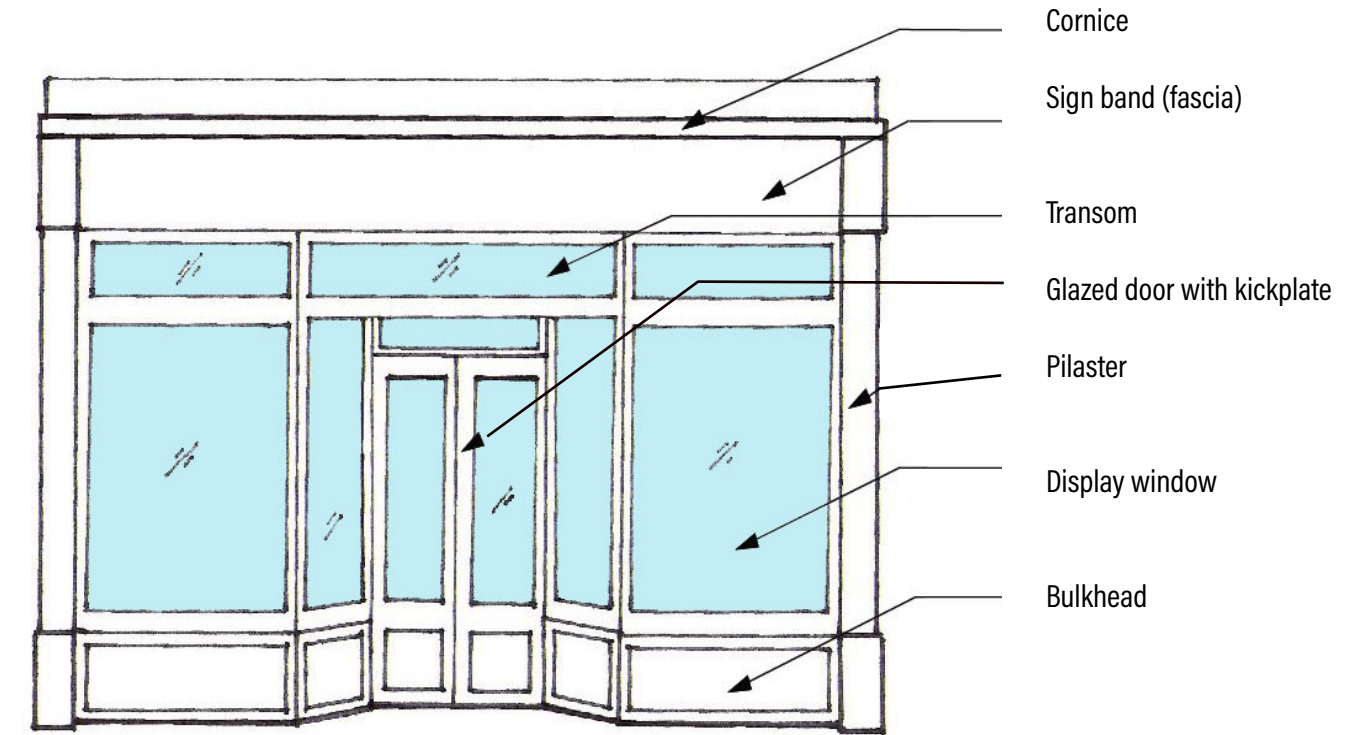

B. STOREFRONT FENESTRATION TRANSPARENCY

1. Central District (DPH-1): minimum = 50%; maximum = 80% (*Division 4: Section 138-4424; Central District: Table 138-4424.c*)
2. West District (DPH-2): Florida Avenue only: minimum = 40%; maximum = 80% (*Division 4: Section 138-4425; West District: Table 138-4425.c*)
All other streets: minimum = 30%; maximum = 80% (*Division 4: Section 138-4425; West District: Table 138-4425.c*)
3. Neighborhood District (DPH-3): minimum = 20%; maximum = 70% (*Division 4: Section 138-4426; Neighborhood District: Table 138-4426.c*)
4. Boulevard District (DPH-4): minimum = 20%; maximum = 70% (*Division 4: Section 138-4427; Boulevard District: Table 138-4427.c*)

V. WINDOWS & DOORS

A. WINDOWS*

Typical configurations shown below—the mixing of light configurations is discouraged:



Single unit, DHS 2/2

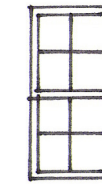

Single unit, DHS 4/4

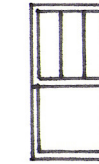

Single unit, DHS 3/1

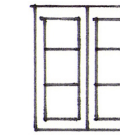
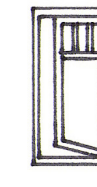

Single or paired casement 3- or 4-light

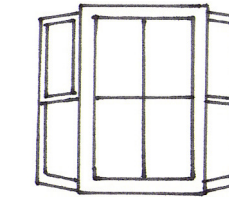

Hexagonal bay, upper story only

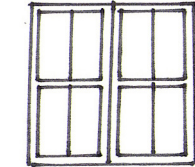

Paired units, Rear only

B. DOORS*

Typical configurations shown below:

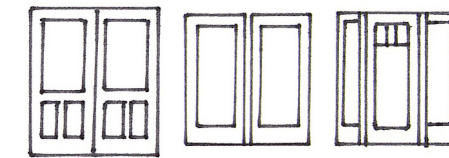

Main entrance, commercial

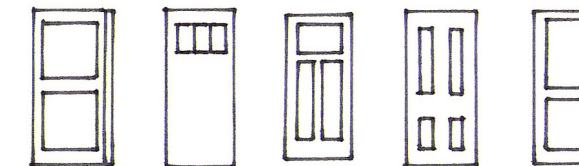

Residential & side/service entrances for commercial

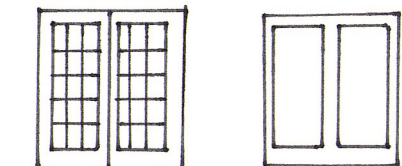

Balcony or patio, rear only

* Use externally applied grids on Simulated Divided Light windows as shown here:



VI. MATERIALS

A. WALL TREATMENT, FRAME*

1. Main wall treatments

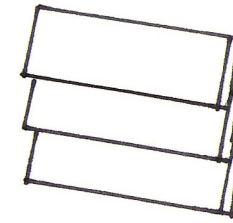

Bevel lap

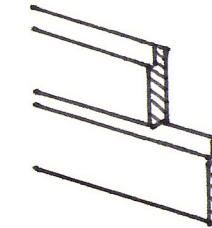

Cove lap (Dutch)

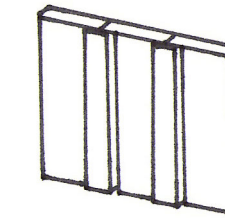

Board & batten

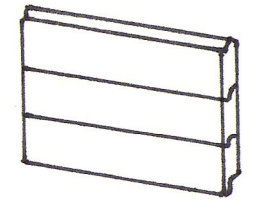

Flush (shiplap)

2. Accent treatments & details

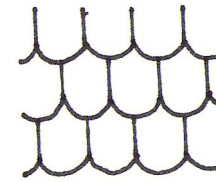

Shingle, half round

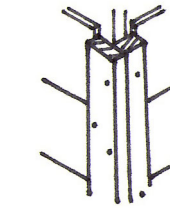

Cornerboard

B. WALL TREATMENT, MASONRY

1. Main wall materials

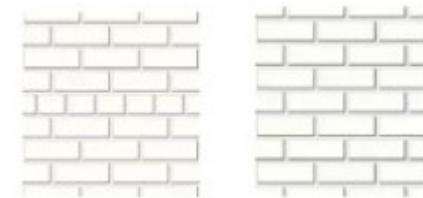

Fired clay brick, common bond or running bond

* Materials may be wood, fiber-cement, or polymer-fly-ash products.

2. Accent materials & details



Rusticated face, running bond
(foundation, water table only)

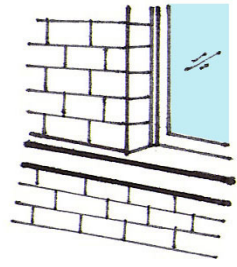

Window recessed from
masonry wall face

C. CORBELS & BRACKETS

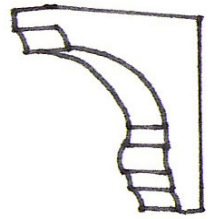

Ogee corbel

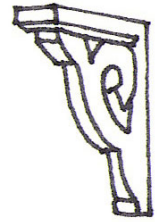

Jigsaw bracket

D. TRIM, WINDOW & DOOR OPENINGS

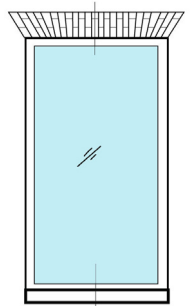

Masonry

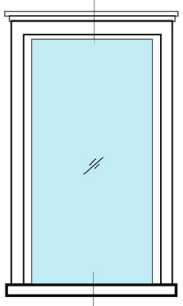

Frame

E. COLUMNS/POSTS & RAILINGS

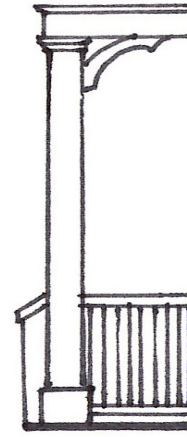

Square post with chamfer & bracket,
square balusters

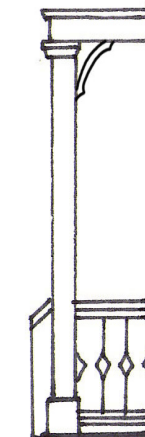

Square post with chamfer & bracket,
flat sawn baluster

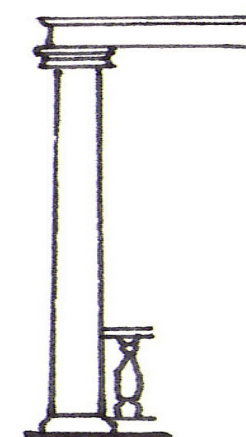

Round column with base & capital,
turned baluster

F. ROOF MATERIALS



Asphalt shingle, architectural



Asphalt shingle, diamond or hexagonal

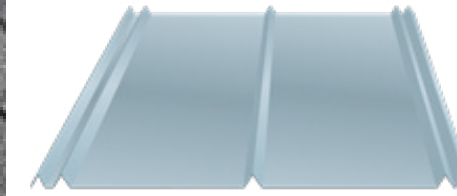

Metal, V-crimp



Metal, standing seam

