



New Government Campus

PROGRESS TOUCHPOINT
Board of County
Commissioners
May 19, 2026



Williamson
Design
Associates



BUILDING DESIGN CONCEPTS

KEY BUILDING FAÇADE CONSIDERATIONS

Site & Orientation

- Sun Path & Shading
 - Under 40% glazing to reduce heat gain
 - Reduce southern-facing glazing, and introduce shading elements
- Public Facades along Icot and Ulmerton
 - Maintain Civic frontage
 - Display a strong presence and firm anchor

Experience

- Differentiate Justice and Administration wings, while presenting as a single building
- Clear wayfinding and entry
- Connect interior program with exterior presence

BUILDING DESIGN CONCEPTS

Projected Colonnade

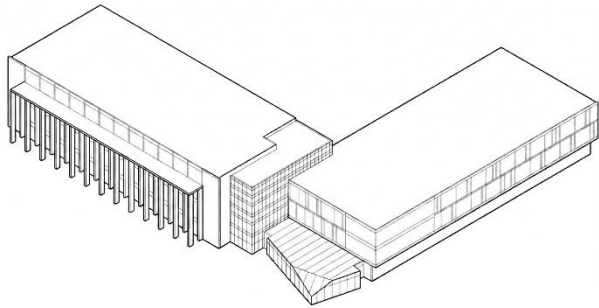

- Justice & Admin are unique
- Prominent Judicial façade
- Projected Colonnade

Recessed Colonnade

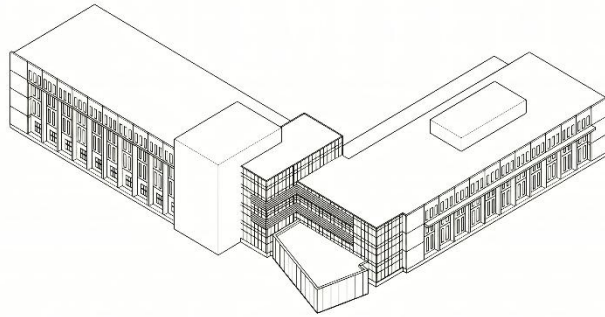

- Shared design language
- Recessed Colonnade

Picture Frame

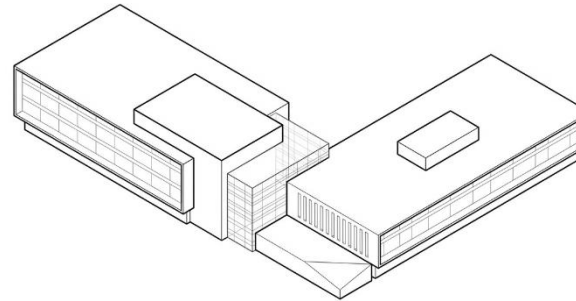

- Shared design language
- Repeating façade elements

Expressive Screen

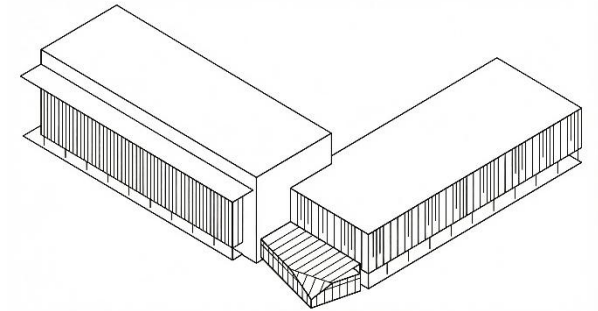

- Shared but distinct design languages
- Prominent Judicial façade
- Iconic identifiable appearance

PROJECTED COLONNADE

Design Highlights

- Justice & Admin are unique
- Prominent Judicial façade
- Projected Colonnade

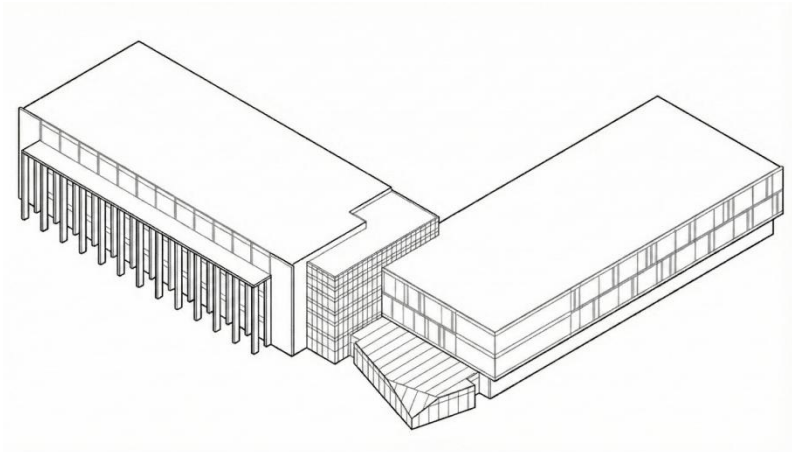











RECESSED COLONNADE

Design Highlights

- Shared design language
- Recessed Colonnade

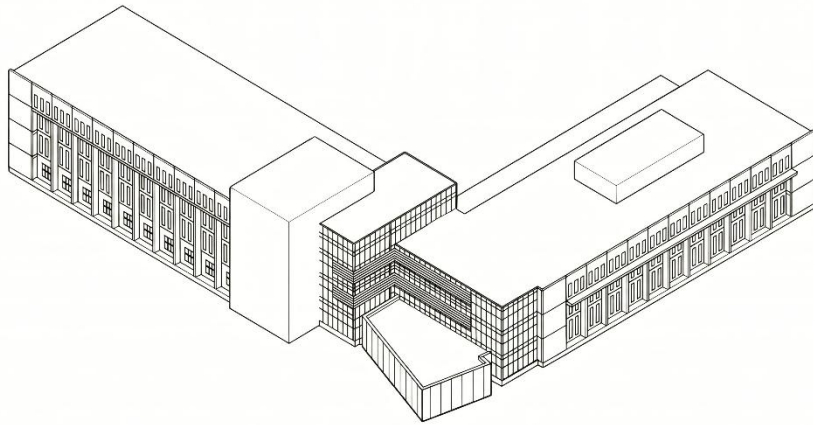

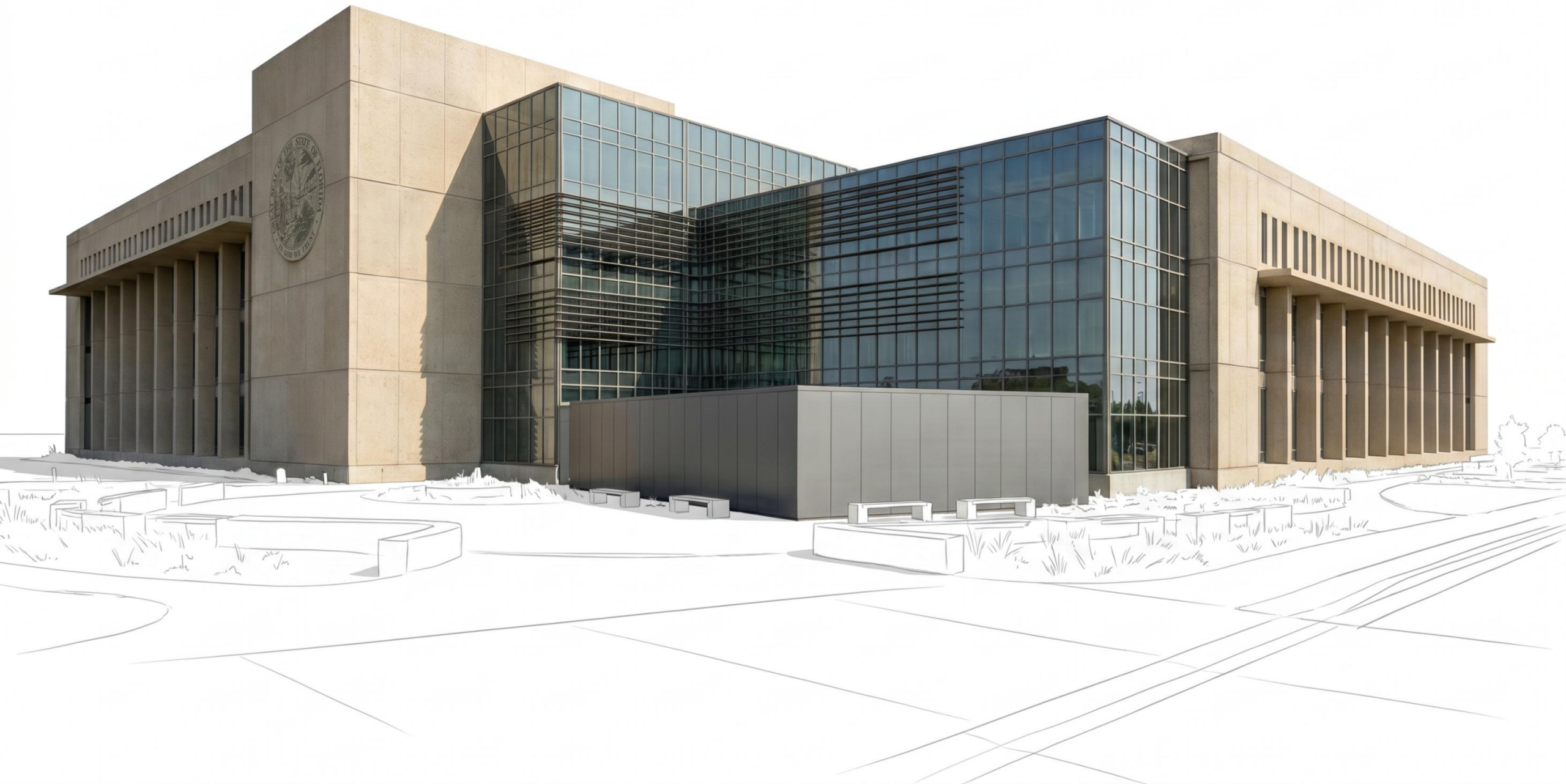





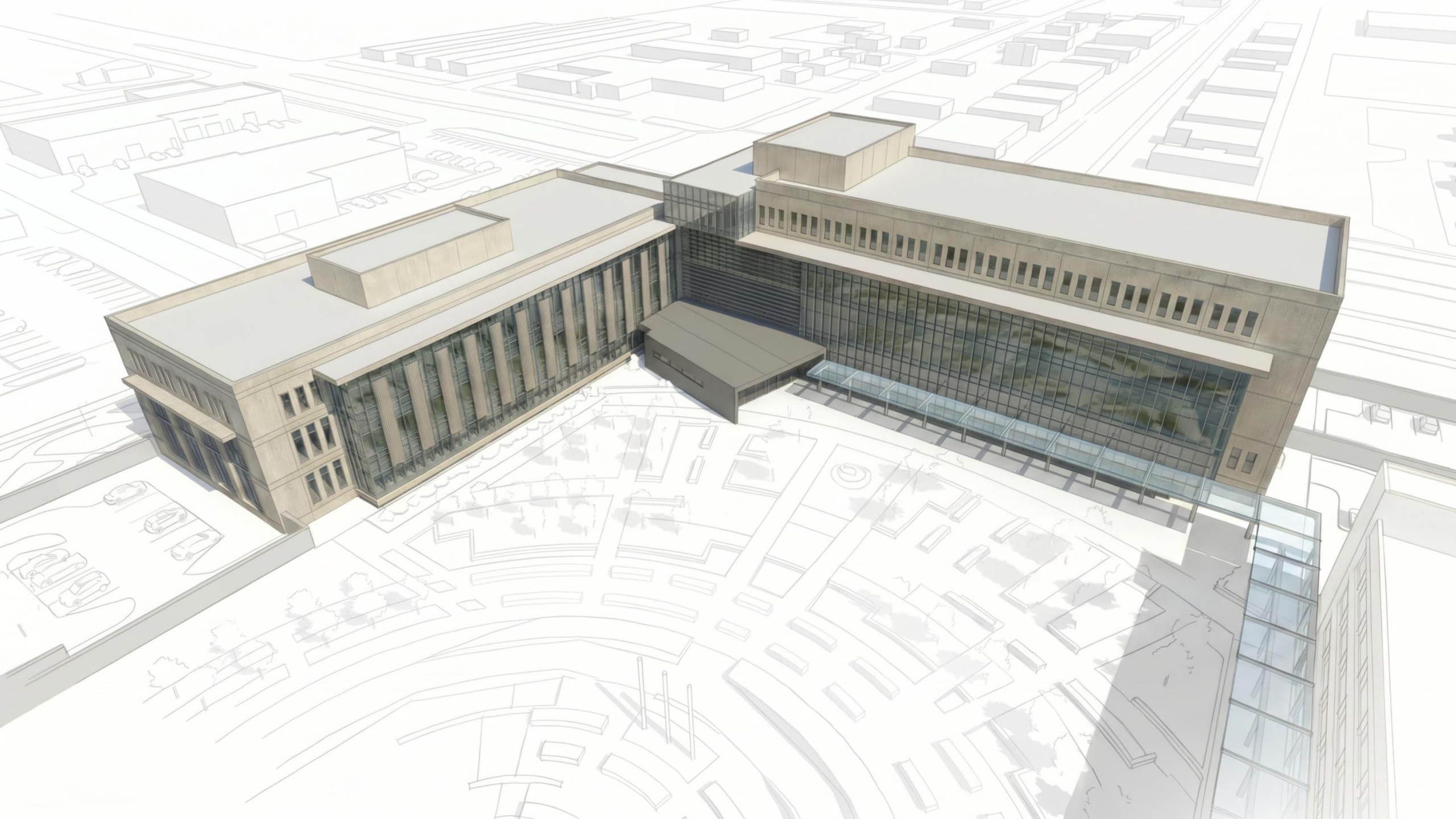



PICTURE FRAME

Design Highlights

- Shared design language
- Repeating façade elements

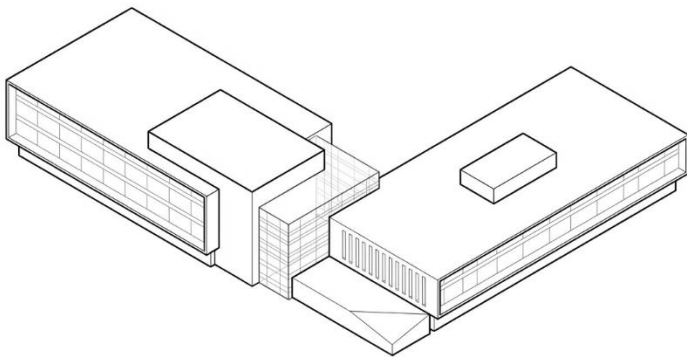











EXPRESSIVE SCREEN

Design Highlights

- Shared but distinct design languages
- Prominent Judicial façade
- Iconic identifiable appearance

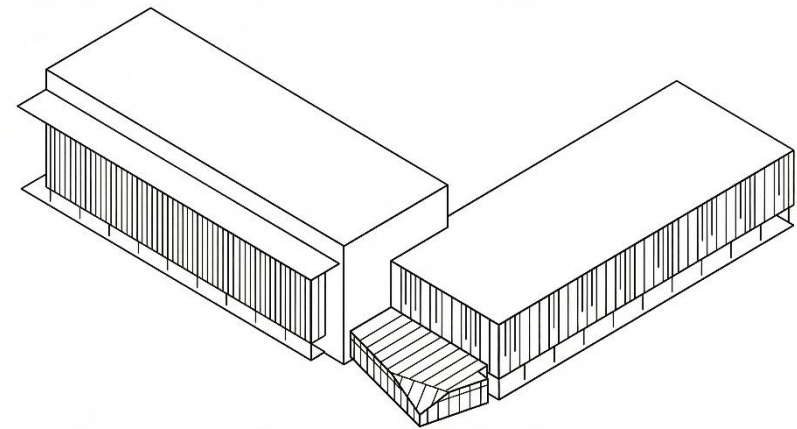











CONCEPT COMPARISON

Projected Colonnade



Recessed Colonnade



Picture Frame



Expressive Screen

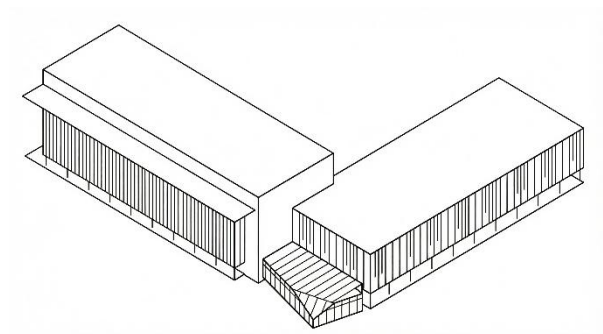
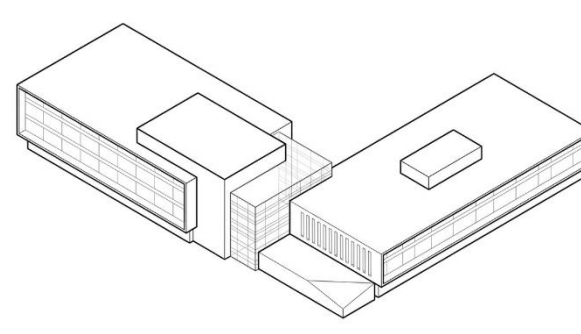
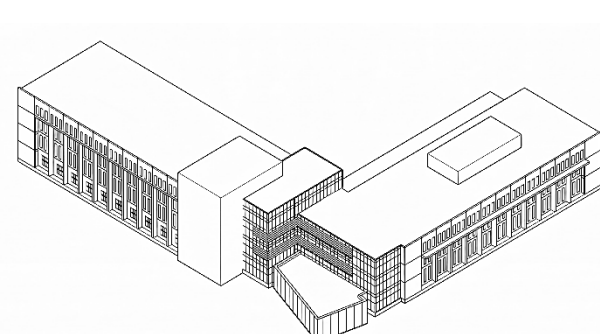
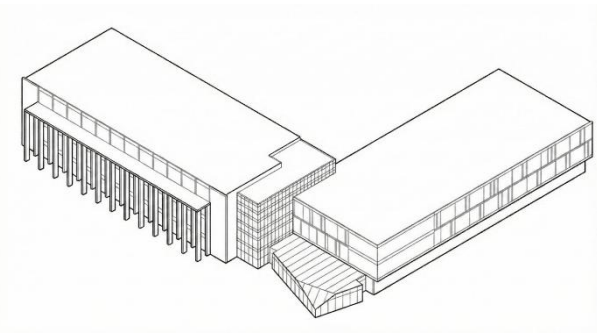



Next Steps